

SMITHSONIAN INSTITUTION  
UNITED STATES NATIONAL MUSEUM

Bulletin 71

---

A MONOGRAPH OF THE FORAMINIFERA  
OF THE NORTH PACIFIC OCEAN

---

PART VI. MILIOLIDAE

---

BY

JOSEPH AUGUSTINE CUSHMAN

*Of the Boston Society of Natural History*



WASHINGTON  
GOVERNMENT PRINTING OFFICE

1917

**BULLETIN OF THE UNITED STATES NATIONAL MUSEUM.**

**ISSUED JUNE 15, 1917**

**ii**

## INTRODUCTION.

---

The present volume is the sixth and last of a series dealing with the Foraminifera of the North Pacific Ocean. It contains the Foraminifera included in the family Miliolidae. The first part, issued in 1910, included the families Astrorhizidae and Lituolidae; the second part, issued in 1911, the family Textulariidae; the third part, issued in 1913, the family Lagenidae; the fourth part, issued in 1914, the families Chilostomellidae, Globigerinidae, and Nummulitidae; and the fifth part, issued in 1915, included the family Rotaliidae.

JOSEPH AUGUSTINE CUSHMAN.

## TABLE OF CONTENTS.

---

	Page.
Introduction.....	1
Phylogenetic development of the Miliolidae.....	1
Family 10. Miliolidae.....	23
Subfamily 1. Cornuspirininae.....	24
Genus <i>Cornuspira</i> .....	24
<i>foliacea</i> .....	24
<i>involvens</i> .....	25
<i>lacunosa</i> .....	26
Genus <i>Ophthalmidium</i> .....	27
<i>inconstans</i> .....	28
<i>tumidulum</i> .....	28
Genus <i>Spiroloculina</i> .....	29
<i>depressa</i> .....	29
<i>canaliculata</i> .....	30
<i>grateloupi</i> .....	31
<i>acutimargo</i> .....	31
<i>tenuimargo</i> .....	32
<i>tenuissima</i> .....	32
<i>robusta</i> .....	33
<i>milletti</i> .....	33
<i>nuda</i> .....	34
<i>costifera</i> .....	34
<i>unicostata</i> .....	35
<i>grata</i> .....	35
var. <i>angulata</i> .....	36
<i>arenaria</i> .....	36
Genus <i>Planispirina</i> .....	37
<i>sphaera</i> .....	37
Genus <i>Vertebralina</i> .....	37
<i>striata</i> .....	38
<i>insignis</i> .....	39
Genus <i>Nodobacularia</i> .....	39
<i>tibia</i> .....	39
<i>irregularis</i> .....	40
Genus <i>Nubecularia</i> .....	40
<i>lucifuga</i> .....	41
<i>bradyi</i> .....	41
Subfamily 2. Quinqueloculininae.....	41
Genus <i>Quinqueloculina</i> .....	42
<i>agglutinans</i> .....	42
<i>alveoliniformis</i> .....	43
<i>agglutinata</i> .....	43
<i>subarenaria</i> .....	44
<i>arenacea</i> .....	44
<i>seminulum</i> .....	44
<i>procera</i> .....	45

## Family 10. Miliolidae—Continued.

## Subfamily 2. Quinqueloculininae—Continued.

## Genus Quinqueloculina—Continued.

	Page.
venusta.....	45
vulgaris.....	46
auberiana.....	46
cuvieriana.....	47
bicostata.....	47
bicornis.....	48
var. elegans.....	48
disparilis.....	48
var. curta.....	49
costata.....	49
boueana.....	50
parkeri.....	50
ferussacii.....	50
amygdaloides.....	51
dutemplei.....	51
bradyana.....	52
undulata.....	52
rugosa.....	53
subrotunda.....	53
pygmaea.....	54
ferox.....	54
spiralis.....	54
cultrata.....	54
macilenta.....	55
reticulata.....	55
schauinslandi.....	56
<b>Genus Massilina</b> .....	<b>56</b>
secans.....	57
annectens.....	57
crenata.....	57
<b>Genus Articulina</b> .....	<b>58</b>
conico-articulata.....	58
sagra.....	59
sulcata.....	60
<b>Genus Sigmoidilina</b> .....	<b>60</b>
celata.....	61
sigmoidea.....	61
<b>Genus Hauerina</b> .....	<b>62</b>
bradyi.....	62
circinata.....	63
ornatissima.....	63
fragilissima.....	64
pacifica.....	64
<b>Genus Triloculina</b> .....	<b>65</b>
trigonula.....	65
tricarinata.....	66
circularis.....	67
var. sublineata.....	68
cylindrica.....	68
oblonga.....	69
suborbicularis.....	70

## Family 10. Miliolidae—Continued.

## Subfamily 2. Quinqueloculininae—Continued.

## Genus Triloculina—Continued.

	Page.
deplanata.....	70
labiosa.....	70
fichteliana.....	71
cuneata.....	71
cribrostoma.....	71
terquemiana.....	72
insignis.....	72
linnaeana.....	72

Genus Adelosina.....	73
laysanensis.....	73

Genus Biloculina.....	73
depressa.....	74
murrhyna.....	75
serrata.....	75
sarsii.....	76
vespertilio.....	77
elongata.....	78
globulus.....	78
anomala.....	79
lucernula.....	79
denticulata.....	80
var. striolata.....	80
comata.....	81
var. serratula.....	81
millettii.....	81
semicostata.....	82
flintii.....	82

Genus Nevillina.....	83
coronata.....	84

Genus Peneroplis.....	84
pertusus.....	86
var. planatus.....	87
var. carinatus.....	87
var. arietinus.....	88

Genus Orbiculina.....	88
adunca.....	91

Genus Orbitolites.....	92
marginalis.....	92
duplex.....	94
complanata.....	95

Genus Alveolina.....	97
melo.....	97
bosci.....	98

Explanation of plates.....	99
----------------------------	----

Index.....	104
------------	-----

# A MONOGRAPH OF THE FORAMINIFERA OF THE NORTH PACIFIC OCEAN.

MILIOLIDAE.

---

BY JOSEPH AUGUSTINE CUSHMAN,

*Of the Boston Society of Natural History.*

---

## INTRODUCTION.

This sixth and last part of the work on the North Pacific Foraminifera deals with the single family Miliolidae. By most writers this family has been considered as very primitive on account of its apparently having no pores in the test, but it has gradually been ascending in the scale. In the *Challenger* report it was the earliest family considered, but has since by many writers been placed above the arenaceous forms of the Astorhizidae and Lituolidae.

The discovery by several workers that the earlier chambers of some of the highest genera of the family have a perforate test shows that it developed from a perforate ancestry. The geological history of the family is also rather conducive to the idea that it developed rather later than other relatively highly developed types as the Nummulitidae, where *Fusulina*, one of the complex types, was characteristic of the Carboniferous. The greatest development of the Miliolidae as far as number of species and complexity of structure are concerned seems to have been the late Cretaceous and early Tertiary.

The present paper does not contain as many species as would be the case were the present collections better represented by shallow-water material, especially about the tropical islands of the area.

## PHYLOGENETIC DEVELOPMENT OF THE MILIOLIDAE.

To d'Orbigny must be given the credit for the first critical study of the foraminifera belonging to the Miliolidae. Previous authors had described and named certain of the species, but very little attempt had been made to determine the relationships of the various forms. In his work in 1826 d'Orbigny<sup>1</sup> recognized many of the still accepted generic characters and to a certain extent their relationships. Under the Foraminifères, Order Agathistegnes, d'Orbigny grouped the

---

<sup>1</sup> Tableau méthodique de la classe des Céphalopodes, Ann. Sci. Nat., vol. 7 1826, p. 245, etc.

genera *Biloculina*, *Spiroloculina*, *Triloculina*, *Articulina*, *Quinqueloculina*, and *Adelosina*, all genera which he described.

Perhaps d'Orbigny's most important contribution was the recognizing of the relative position of the chambers and the consequent number visible from the exterior. The chamber arrangement, very definitely described and figured by d'Orbigny, was not in some cases later recognized by subsequent authors as of generic importance.

By the early English group of workers on the Foraminifera, Carpenter, Parker, Jones, and Brady, the genus *Miliolina* was taken to include *Triloculina* and *Quinqueloculina* as well as certain other genera. These two genera mentioned were not understood as described by d'Orbigny, as may be seen by Carpenter's figures of *Quinqueloculina*, which are really copies of Parker's figures in an earlier paper.<sup>1</sup>

Parker's ideal transverse sections (on p. 57, fig. 5, *a*, *b*, and *c*) do not represent *Quinqueloculina* as described by d'Orbigny. Moreover the various genera and their different characters were only recognized by Carpenter and others as pure variations. The fact that these animals were unicellular has in the minds of many workers on the Foraminifera presupposed an unlimited amount of variation and the explanation of nearly all different characters on this basis. The larger work of Carpenter, Parker, and Jones, *Introduction to the Study of the Foraminifera*, 1862, helped greatly to fix this idea of unlimited variation and the supposed lack of any definite characters. An example of the extreme view of Carpenter is shown in his introduction (p vii) in the following words: "*Sharply defined divisions—whether between species, genera, families, or orders—do not exist among Foraminifera.*"

Brady in the *Challenger* report and elsewhere breaks away somewhat from the extreme of these views in that he describes new species and genera, but he is plainly influenced by the work of Carpenter and tries to unite various forms on the basis of variation rather than seeking the true explanation of their differences. Brady figures sections of some of the Miliolidae, but the important early chambers are usually indistinct and he makes little reference to them.

Goës<sup>2</sup> adopted early adopted extreme views of variability in the Foraminifera and the uselessness of distinguishing more than a few central species about which the others should be grouped as variants. As an example of his extreme views at this time, he includes under the genus *Miliola* three species, the first of which, *M. seminulum* (Linnaeus), he divides into six varieties. Under this species Goës includes as synonyms more than a hundred specific names and five

<sup>1</sup> On the Miliolitidae (Agathistègnes d'Orbigny) of the East Indian Seas, Part I, *Miliola*, *Ann. Mag. Nat. Hist.*, ser. 2, vol. 6, 1858, p. 53, etc.

<sup>2</sup> On the Reticularian Rhizopoda of the Caribbean Sea, *Kongl. Svensk. Vet. Akad. Handl.*, vol. 19, No. 4, 1882.



of the genera of d'Orbigny. The second species includes species usually assigned to *Biloculina*, and the third species those belonging to *Spiroloculina*. Thus Goës includes seven of the genera of d'Orbigny under *Miliola*, and extreme view not taken by even the most radical of the British group of workers along this line.

Twelve years later in another paper<sup>1</sup> Goës shows a decided change in attitude. The genera *Biloculina* and *Spiroloculina* are recognized, and *Miliola* contains the other genera. Instead of grouping all under three species, Goës allows 37 species, variously grouped as subspecies and species and describes four new species. Two years later in still another paper<sup>2</sup> Goës recognized also the genus *Sigmoilina* of Schlumberger in addition to those recognized in 1894. One new species of the Miliolidae is described. In this paper, besides Miliolidae, Goës describes over 20 new species and varieties, as well as some new genera. In this last paper, and especially the preceding one, many excellent sections of Miliolidae are figured, showing the stages in development, but little use is made of them.

To Munier-Chalmas and Schlumberger, especially to the latter, must be given credit for the elucidation of the real structure of many of the generic types of the Miliolidae. Their researches are based upon painstaking work in sectioning great numbers of specimens, both fossil and recent, belonging to this family. Their work was, in the main, the search for and demonstration of the two forms, microspheric and megalospheric, in the various species and the basing of generic characters upon definite morphological structure. The immature characters are not as fully dwelt upon as probably would have been done had Schlumberger lived to continue his work. The many new genera Schlumberger described have basis in structure and developmental characters and are restored to their rightful value, although modified somewhat by certain later views as to their scope. Altogether the work of Schlumberger is the most valuable work of any student of the Miliolidae as regards the demonstration of Dimorphism (used in the sense of the two distinct generations) in many species and the early stages in the development of various generic types.

Rhumbler has studied especially the *Peneroplis* group and the peculiar double forms of *Orbitolites*. He demonstrated the perforate character of the proloculum of *Peneroplis*.

Lister has worked mainly with the *Peneroplis* group, *Peneroplis*, *Orbiculina*, and *Orbitolites*, as far as the Miliolidae are concerned. He demonstrated the perforate character in the proloculum of the last two genera and has done much work on the dimorphism of various species.

---

<sup>1</sup> A Synopsis of the Arctic and Scandinavian Recent Marine Foraminifera, Kongl. Svensk. Vet.-Akad. Handl., vol. 25, No. 9, 1894.

<sup>2</sup> On the Foraminifera of the Galapagos Islands, etc., Bull. Mus. Comp. Zool., vol. 29, No. 1, 1896.

Chapman has demonstrated the two forms of *Alveolina*, and the series of these larger forms is now nearly complete.

To Lister and Schaudinn we owe much of the knowledge of the life history of the Foraminifera and the relation of dimorphism to the life cycle. Many other investigators have added, in greater or lesser degree, to our knowledge of the Foraminifera, but the names noted above stand out prominently in the history of the work in the development of the Miliolidae.

*Proloculum*.—The proloculum or initial chamber of the Foraminifera as seen in the Miliolidae consists of an oval or subspherical chamber. The test of the proloculum in some genera (*Peneroplis*, *Orbiculina*, and *Orbitolites*) is clearly perforate, while this character has not been made out in other genera.

The proloculum is the first distinct stage in the development of the test. Although in the Miliolidae there is no distinctly single cham-

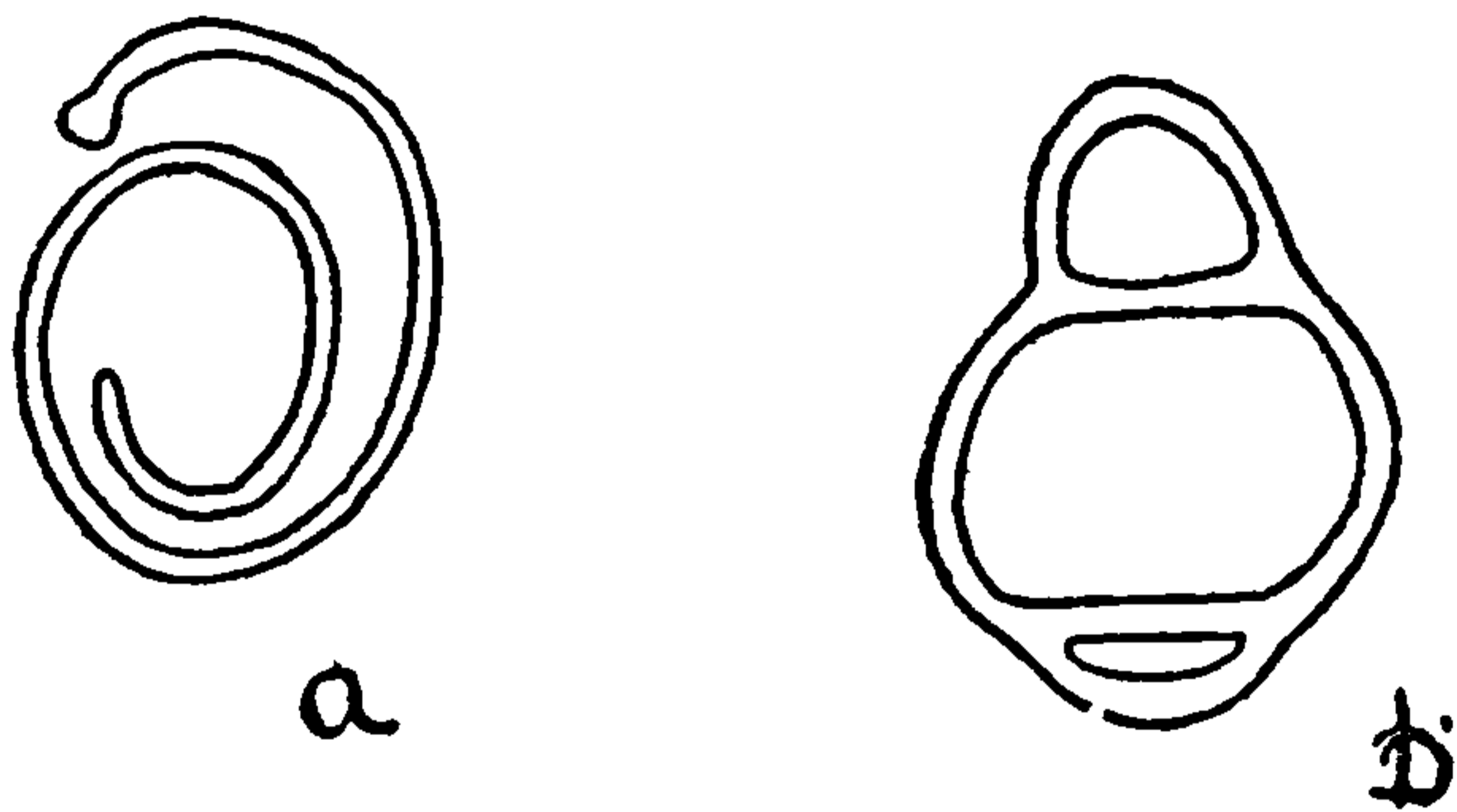

FIG. 1.—“EMBRYONIC YOUNG” OF MILIOLIDAE, IN THIS CASE OF *PENEROPLIS*, TAKEN FROM THE “MOTHER TEST.” (AFTER SCHACKO  $\times 420$ .) *a*, LONGITUDINAL SECTION SHOWING THE PROLOCULUM, OVAL IN SHAPE FOLLOWED BY THE LONG CORNUSPIRA-LIKE SECOND CHAMBER; THE WALL OF THE TWO CONTINUOUS AND OF THE SAME THICKNESS. *b*, TRANSVERSE SECTION SHOWING THE SECOND CHAMBER AT THE TWO SIDES OF THE PROLOCULUM, THE UNIFORM SINGLE WALL AND THE FLATTENING OF THE SIDES OF THE PROLOCULUM WHERE THE SECOND CHAMBER IMPINGES UPON IT, AN ADDED PROOF THAT THE TWO ARE FORMED AT THE SAME TIME.

bered form which may be considered as the radicle (like *Lagena* for the family of the Lagenidae), it is fair to assume that there was in the early development of the group a single-chambered form. This radicle, although not definitely known as an adult, is represented by the proloculum or first stage in the development of the many chambered forms of the family. The size of the proloculum is of great importance, as will be considered in later discussion.

*Characters of the “embryonic” young of Miliolidae*.—The production of young in a number of genera of the Miliolidae has been noted by several observers. The young individuals are formed inside the chambers of the adult test, especially in the outer and larger chambers. The characters throughout the family in this “embryonic” stage seem to be very uniform. A detailed description of this stage in the development will be useful for later comparison.

The young individual (fig. 1) when set free from the “mother” cell consists of two distinct stages in its test characters. The first chamber is a globose proloculum in all normal individuals. Exceptions to this condition will be noted later. The second chamber consists of a nonseptate tube close coiled about the proloculum. Seen from the

side (fig. 1a) the width of the tube increases from its inception until the broadest part is developed near the distal end. Seen in vertical view this tube has a nearly uniform width. In cross section (fig. 1b) the various parts of the tube are seen to have a considerable difference in height. The proximal portion is low and flattened, the side adjacent to the proloculum being nearly flat, the outer side convex. The height of the tube increases from this point toward the distal end, where its height may equal the width. The aperture is contracted and considerably smaller than the diameter of the tube. The length of this second chamber is rather constant, being usually between a half and a complete coil.

Another character of especial importance when comparison is made with the early chambers of adult tests is that of the wall. The wall which forms the com-

mon boundary between the proloculum and the second chamber is, as far as can be determined, a single wall, no new shell substance apparently being laid down by the animal on the floor of the tubular chamber. As a result of the walls of the test in its "embryonic" stage are single and of practically uniform thickness. The only exception is the thickening which appears at the aperture of the second chamber. This foreshadows the thickened lip seen in so many of the genera in this family.

*Development of Cornuspira.*—In *Cornuspira*, which is the simplest of any of the family in its development (possibly excepting *Squamulina* or *Nubecularia*, which are degenerate forms), has in reality nothing in addition to the developmental characters seen in "embryonic" young already described. It has a globular or ovoid proloculum followed by a second chamber of indefinite length built on the outside of the previous portion of the test in a planospiral manner

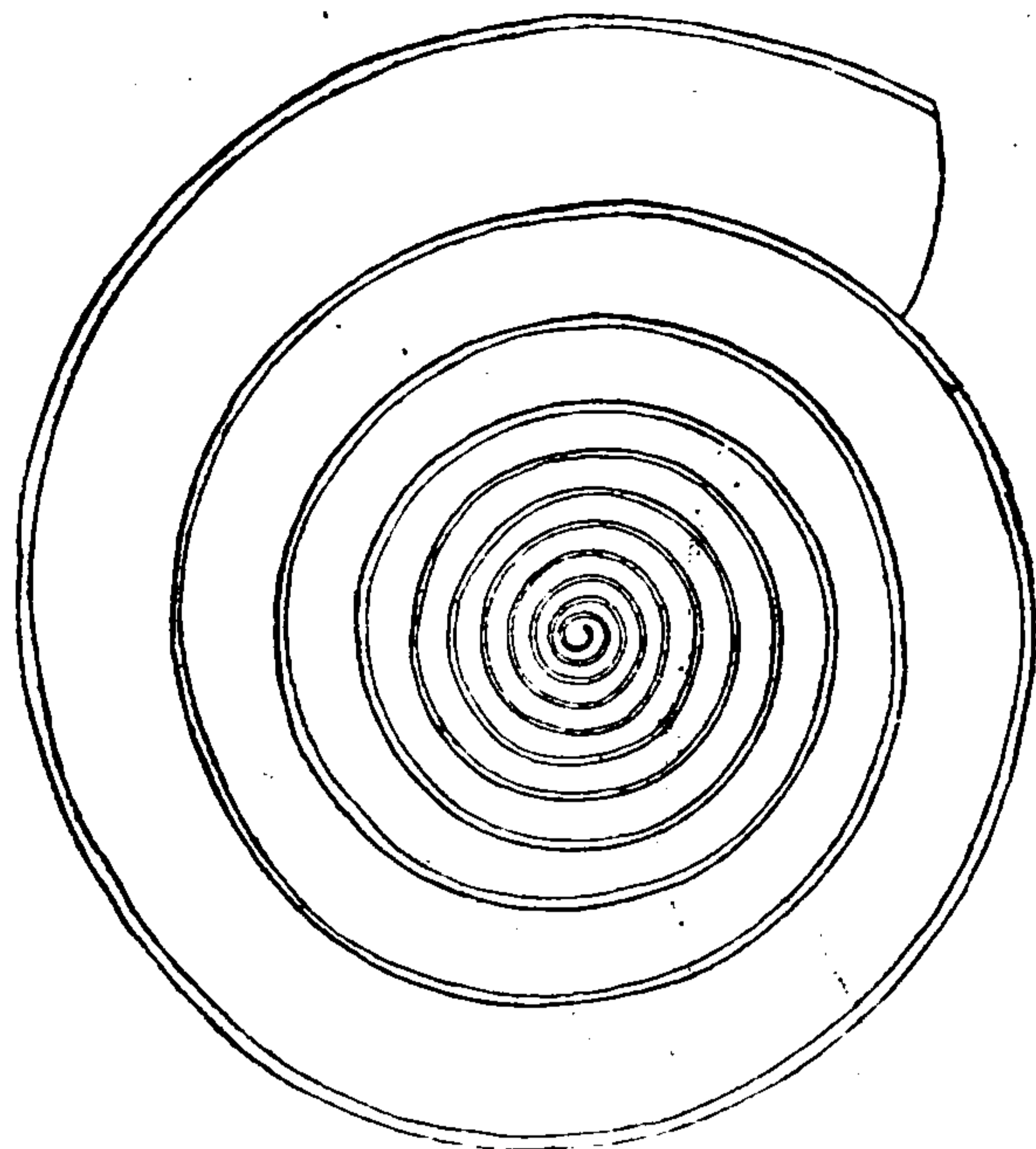

FIG. 2.—*CORNUSPIRA INVOLVENS* REUSS.  $\times 63$ . MICROSOPHERIC SPECIMEN VIEWED BY TRANSMITTED LIGHT. SPECIMEN WITH VERY SMALL PROLOCULUM, BUT WITH ITS NUMEROUS COILS GROWING TO A MUCH LARGER SIZE THAN THE MEGALOSPHERIC FORM WITH ITS MUCH LARGER PROLOCULUM AND FEWER COILS (FIG. 3).

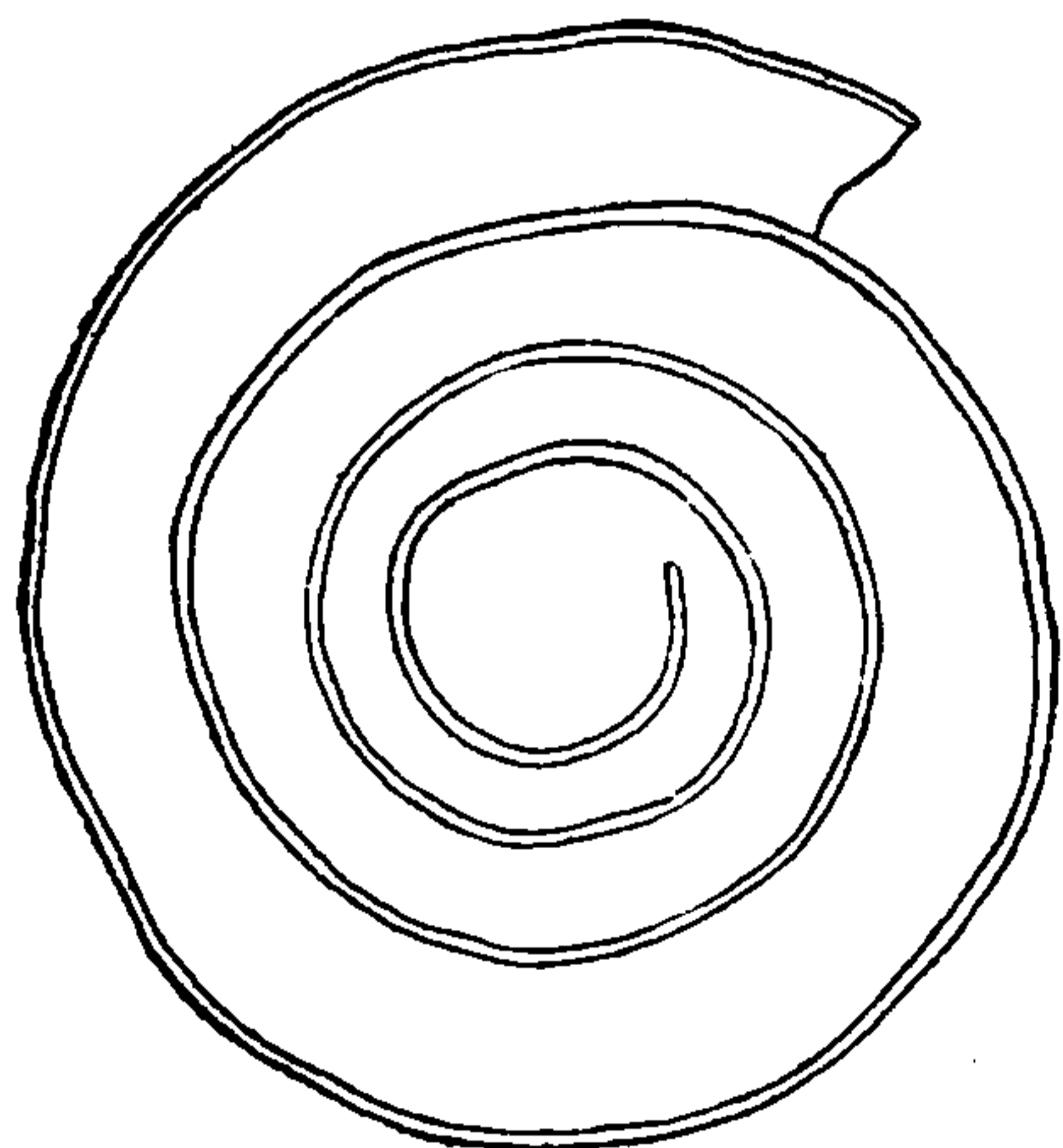

FIG. 3.—*CORNUSPIRA INVOLVENS* REUSS.  $\times 63$ . MEGALOSPHERIC SPECIMEN VIEWED BY TRANSMITTED LIGHT. PROLOCULUM VERY LARGE IN COMPARISON WITH FIG. 1, BUT COILS FEWER AND COMPLETED TEST SMALLER IN DIAMETER.

without building a floor as it proceeds. It differs from the embryonic young only in the length of this second chamber and its various modifications of ornamentation and relative proportions which constitute the specific characters in the various species of *Cornuspira*.

Occasional specimens show a reduction in the size of the tube in the last formed portion as in senescence in some Mollusca. In

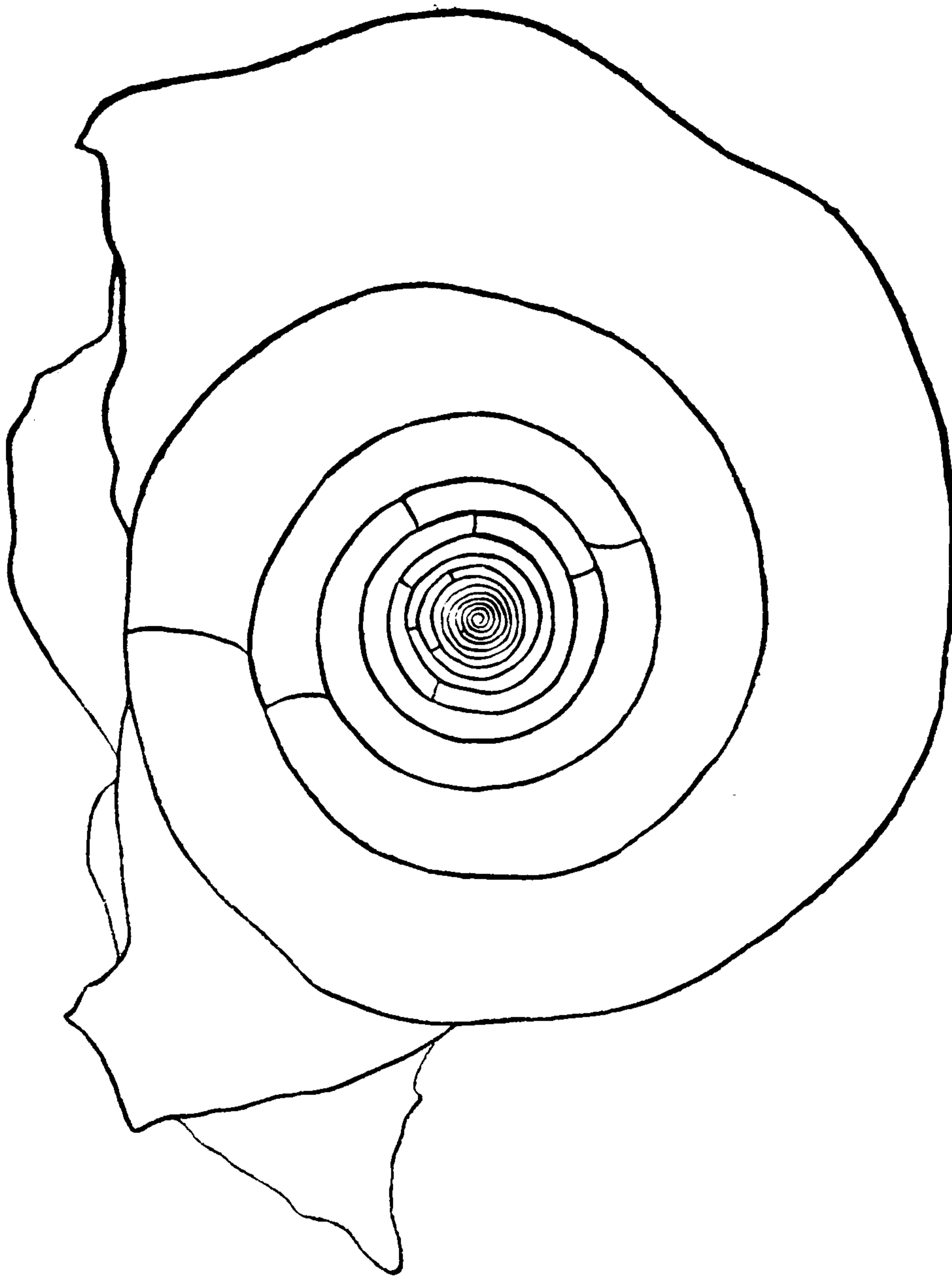

FIG 4.—*COENUSPIRA FOLIACEA* (PHILIPPI).  $\times 24$ . COMPLETE SPECIMEN, THE YOUNG OF WHICH IS SHOWN IN FIG. 5. SPECIMEN SHOWS THE LATER "PARTITIONS" DEVELOPED IN THE LARGER, OUTER COILS OF THE TEST. THE LAST FORMED CHAMBER WAS PARTIALLY BROKEN WHEN FOUND. VIEWED BY TRANSMITTED LIGHT.

others there is a tendency which may be considered rather more prophetic in its nature. In the specimen figured here in outline (fig. 4) is shown a recent specimen which upon first examination seemed to have no characters unlike typical specimens and it was selected for mounting in balsam for a study of the early coils. After mounting examination showed a partial division into chambers

instead of the usual nonseptate condition. In all, 12 partitions were made out. After the proloculum (fig. 5) there are three complete coils of nonseptate tube, as in ordinary specimens. Then the tube is cut off by a "partition." Following this are three and three-quarters coils of nonseptate tube and then another "partition." About a quarter coil beyond is a third "partition," then in each succeeding coil a "partition" is found when a coil has been nearly completed. Again, there is a quarter coil followed by a "partition." From this point there are six "partitions" in the following five coils, without any definite arrangement. A figure shows the arrangement in the earlier chambers (fig. 5).

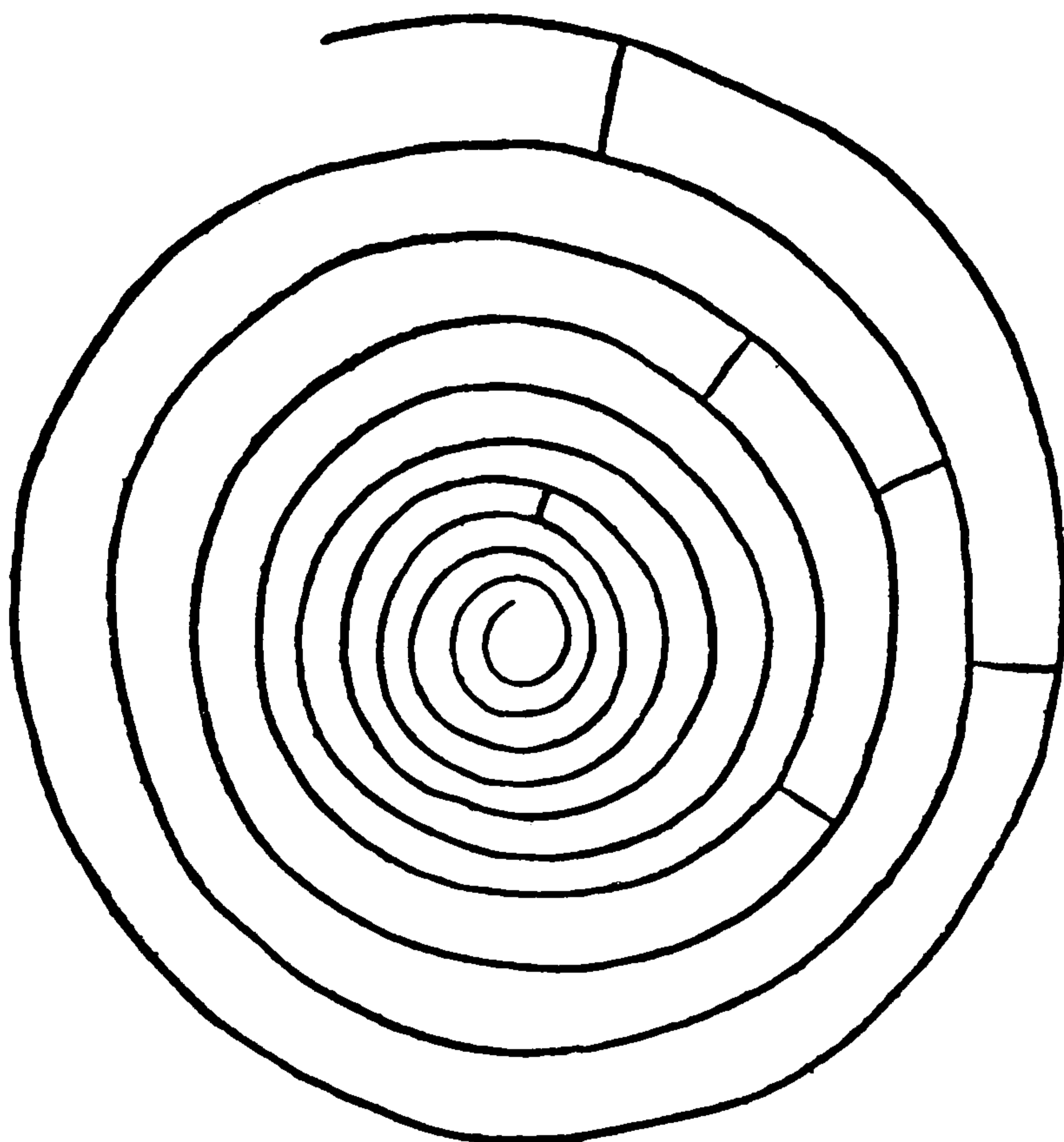

FIG. 5.—*CORNUSPIRA FOLIACEA* (PHILIPPI).  $\times 116$ . EARLY COILS OF MICROSPHERIC SPECIMEN SHOWING THE "PARTITIONS" DEVELOPED AT IRREGULAR INTERVALS IN THE TUBULAR CHAMBER. VIEWED BY TRANSMITTED LIGHT.

Both microspheric and megalospheric specimens occur in various species of the genus. A megalospheric (fig. 3) and microspheric specimen (fig. 2) of *Cornuspira involvens* are here shown in the same magnification. The number of coils in general is in inverse ratio to the size of the proloculum in the two, but, as is usually the rule in the foraminifera, the microspheric form attains the greater size.

*Development of Ophthalmidium.*—The developmental stages of *Ophthalmidium inconstans* H. B. Brady may be taken as showing the general characters of the genus. In this species (fig. 6) there is the

usual oval proloculum (1), followed by a closely coiled tubular chamber (2); the second chamber may be directly compared to *Cornuspira*, and at this stage *Ophthalmidium* has completed the developmental characters of an adult *Cornuspira*. The third chamber (3) introduces several new characters. The first of these is seen in the length of the chamber, which is between two-thirds and three-fourths of a single coil. This characteristic chamber, while seen as a definite stage in this genus, has not been noted as an adult character in any known genus. With this characteristic length of chamber comes another character seen in the tendency to lose the close-coiled condition at the distal end of the chamber. Near the aperture the chamber leaves the preceding chamber and takes a tangential direction, thus standing out from the original direction of coiling. The fourth chamber (4) has the same characteristic length in most cases becoming a little nearer the two-thirds of a coil, being slightly shorter than the preceding, chamber 3. Toward its aperture it also tends to take a tangential direction, so that its apertural portion stands free from the preceding coils. At its beginning this chamber starts at some distance from the inner coils due to the separation of the apertural portion of the preceding chamber (3) from the rest of the test. As a result there is a space left which is filled in by a thin plate like portion of shell. A similar filling is seen where chamber 5 starts its growth. These more or less triangular areas are shown by the smaller dotted areas of the figure. Chamber 4 also adds another really specific character, that of building a peripheral wing-like shell growth about its own outer wall. Thus chamber 4 introduces the specific character of a peripheral wing, although the true generic characters are not yet attained.

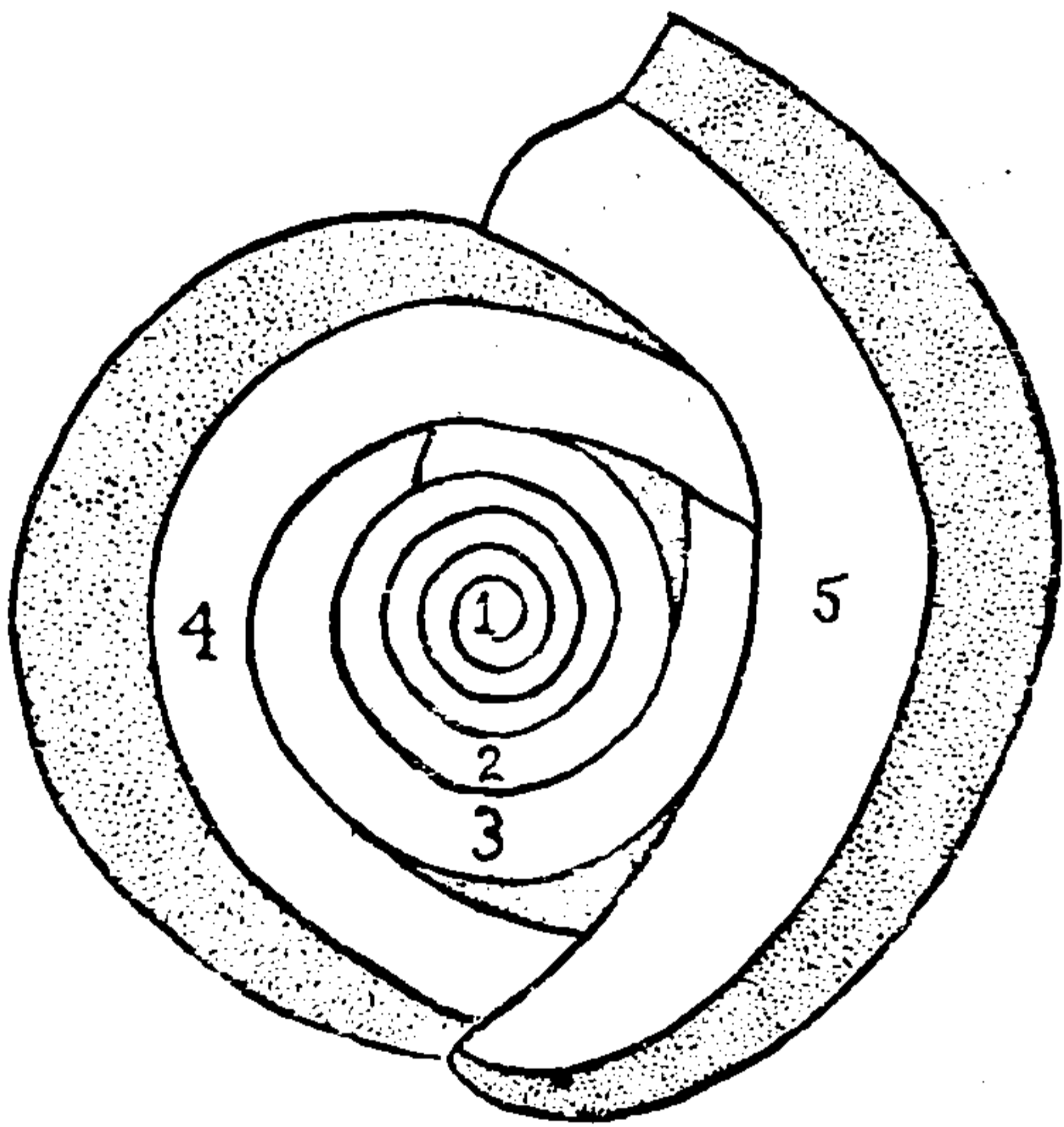

FIG. 6.—OPHTHALMIDIUM INCONSTANS H. B. BRADY.  $\times 65$  (ADAPTED FROM BRADY). YOUNG SPECIMEN VIEWED BY TRANSMITTED LIGHT, SHOWING (1) PROLOCULUM, FOLLOWED BY (2) A LONG CORNUSPIRALIKE SECOND CHAMBER, THREE AND ONE-HALF COILS IN LENGTH, (3 AND 4) CHAMBERS THREE-FOURTHS TO TWO-THIRDS OF A COIL IN LENGTH AND (5) THE FIRST ADULT CHAMBER ONE-HALF OF A COIL IN LENGTH. DOTTED PORTION SHOWS THE FLANGELIKE CARINA.

Chamber 5 initiates the adult characters as far as the genus is concerned. This consists of a chamber making a half coil. In this particular species it also loses the character of uncoiling at its apertural end but has the wing-like growth on its own periphery. Following chambers keep to the character of developing a half coil and a close coiled condition throughout.

Thus standing out from the original direction of coiling. The fourth chamber (4) has the same characteristic length in most cases becoming a little nearer the two-thirds of a coil, being slightly shorter than the preceding, chamber 3. Toward its aperture it also tends to take a tangential direction, so that its apertural portion stands free from the preceding coils. At its beginning this chamber starts at some distance from the inner coils due to the separation of the apertural portion of the preceding chamber (3) from the rest of the test. As a result there is a space left which is filled in by a thin plate like portion of shell. A similar filling is seen where chamber 5 starts its growth. These more or less triangular areas are shown by

In general the genus *Ophthalmidium* has the following development a proloculum, followed by a close-coiled *Cornuspira* chamber of two or more coils in length, in turn followed by a series of chambers in general about two-thirds of a coil in length and tending to uncoil at their apertural ends, the space thus left being filled in by shell growth as the following chamber is built, the adult character being a series of chambers close coiled and one-half a coil in length.

*Development of Planispirina.*—*Planispirina* is a genus not greatly removed in some respects from *Cornuspira* and *Ophthalmidium*. The species *P. exigua* H. B. Brady will serve to show the development. Figure 7 shows a specimen viewed by transmitted light. There is a globose proloculum followed by a very long *Cornuspira*-like second chamber consisting of two and a half coils of continuous tube. In this long second chamber there is a relatively primitive development compared to that seen in the second chamber of *Ophthalmidium*. The third chamber makes a half revolution as does also the fourth. This condition is much like that seen in *Spiroloculina* or in later stages of *Ophthalmidium*. *Planispirina* differs from the young of *Spiroloculina* in its relatively less accelerated second chamber and also in its adult characters. It differs from the young of *Ophthalmidium* in skipping the stage having chambers two-thirds of a coil in length, a stage intermediate between the long chambers of the early stages and the half coil chambers of the adult in *Ophthalmidium*. The fifth chamber is shorter than the preceding ones, in this specimen being about a third of a coil in length. The sixth and seventh chambers complete the coil begun by the fifth chamber and give the adult character, that of a test with three or four chambers in each volution.

From the exterior the chambers of the last coil are clearly visible, but those of the interior are hidden, as there are no definite markings on the surface to indicate the chambers.

*Development of Spiroloculina.*—The genus *Spiroloculina* is much more abundant in number of species and individuals in the Eocene deposits of France than it is in the present ocean. It reached a high development in the Eocene and a number of senescent forms are seen in those formations, more than in the recent species which are comparatively few and simple. *Spiroloculina* differs from its nearer

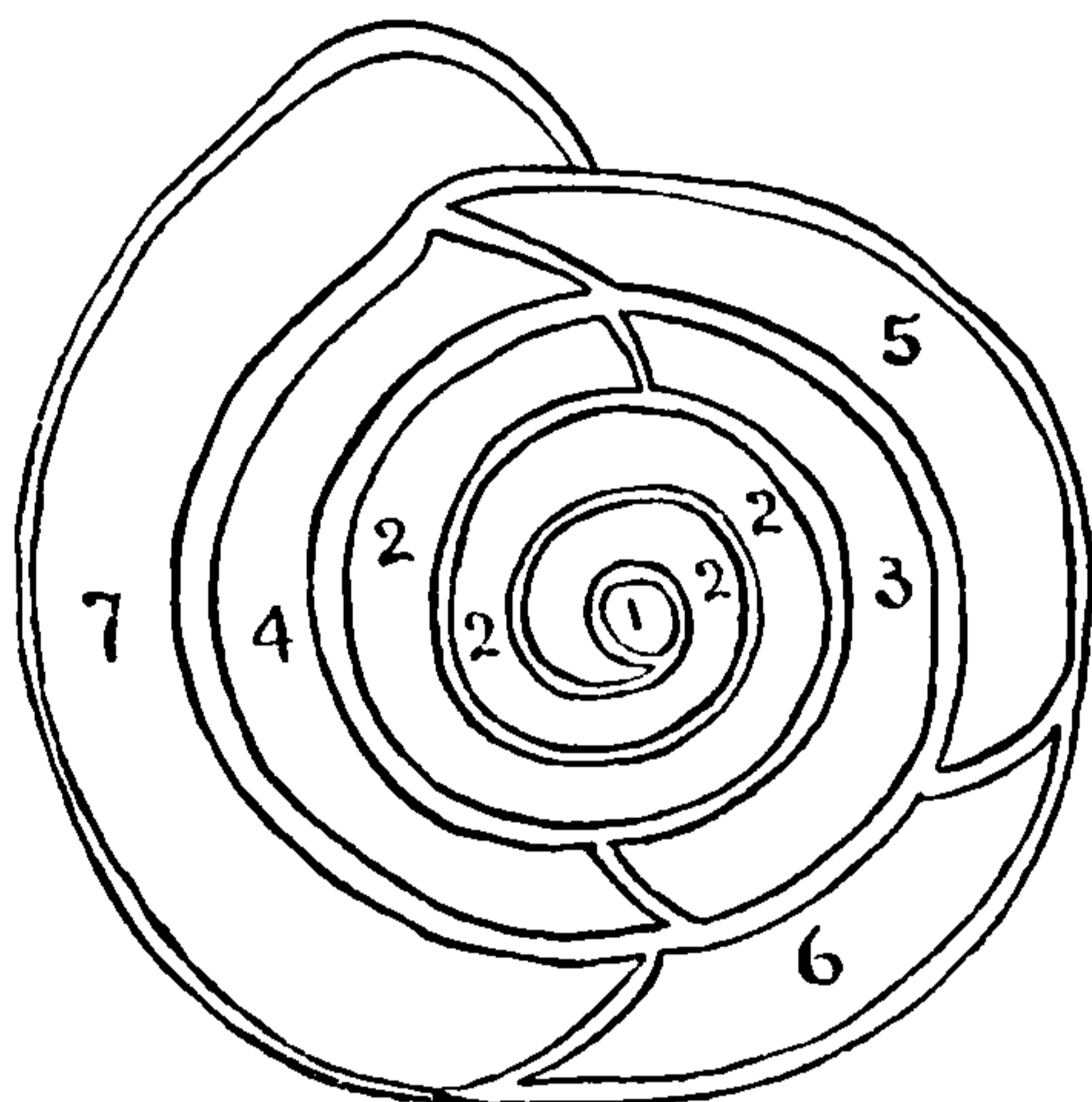

FIG. 7.—PLANISPIRINA EXIGUA H. B. BRADY. (ADAPTED FROM BRADY.) LONG SECOND CORNUSPIRALIKE CHAMBER PROLOCULUM (1). (2) FOLLOWED BY HALF COIL LENGTH (CHAMBERS 3, 4) AND LATER BY ONE-THIRD COIL LENGTH (CHAMBERS 5-7).

allies, mainly in its open coil, there being little if any covering of the preceding whorls by involution. As a result the development is easily studied.

The development of *Spiroloculina bicarinata* d'Orbigny from the Eocene of the Paris Basin of Vandancourt may be taken as typical of an Eocene *Spiroloculina* (fig. 8). The first chamber consists of a globose proloculum. The second is the ordinary close-coiled, tubular, *Cornuspira*-like chamber with no floor as seen throughout the group. In this case its length is a little more than a half coil. The shell

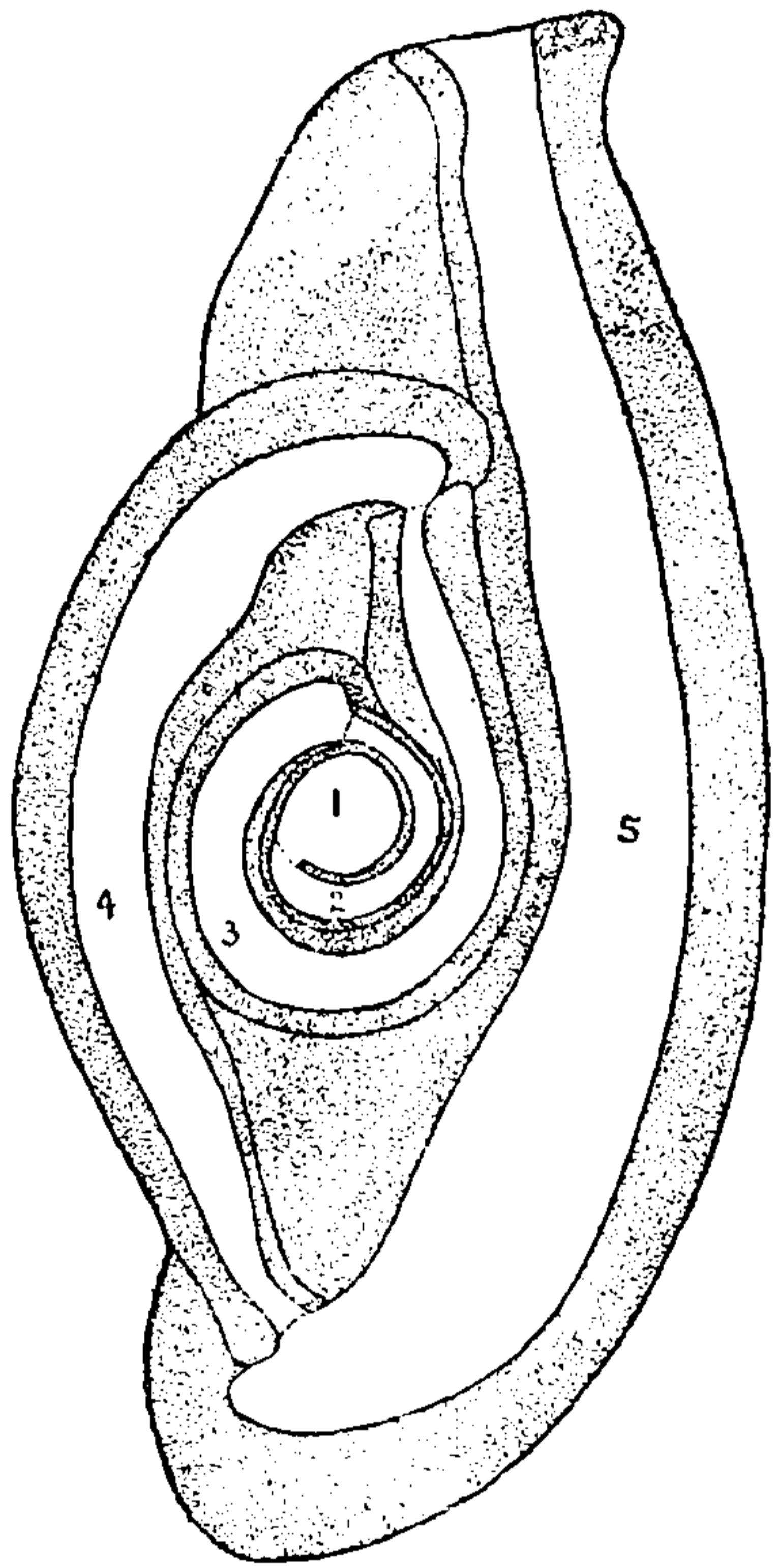

FIG. 8.—SPIROLOCULINA BICARINATA D'ORBIGNY.  $\times 85$ . EOCENE OF VANDANCOURT, PARIS BASIN. SPECIMEN VIEWED BY TRANSMITTED LIGHT. (1) PROLOCULUM, (2) SECOND CORNUSPIRALIKE CHAMBER, (3) ELONGATED CHAMBER, (4, 5) ADULT CHAMBERS A HALF COIL IN LENGTH.

wall of these two chambers is thin and of uniform thickness as in the other genera already described. The third chamber at its inception is more than twice as high as the aperture of the preceding one, but gradually diminishes in height until at its own aperture it is hardly, if at all, higher than the aperture of the preceding chamber. In length it is a little more than a complete coil. It initiates two distinctive features of the genus. One of these is the tendency of the distal portion of the chamber to break away from the close-coiled condition and to change the axis of the chamber to a tangential position. As a result, a tubular neck is formed which is a rather general character among the Eocene species of *Spiroloculina*. Another character which is initiated here is the broad flaring lip at the aperture. This is also characteristic of a majority of the species of this period. This third chamber, therefore, initiates several important characters, but not the one of prime generic importance, the half coil length of chambers in a single plane. Beginning with the fourth chamber the specimen is at once definitely a *Spiroloculina*.

The fifth and succeeding chambers simply add to the size of the individual or to the specific characters, no generic characters having been attained in the fourth chamber.

As the apertural lip when formed extends beyond the rest of the test, the space thus left is filled in before the next chamber is built. This is shown in the specimen figured, which was apparently about to form a new chamber. This shelly growth which is filled in is usually less solid than the rest and may appear of a lighter color when examined as a balsam mount with transmitted light. In some species such as *S. perforata* this space is left open and the new chamber is



built without filling in the intermediate space between the neck and the body of the test. On the basis of this structure a series of perforations occur in the adult test along the long axis at regular intervals.

Another group of Eocene *Spiroloculinae* may be represented by *S. alata* Terquem (fig. 9). In this species the second chamber is shorter than in the preceding (*S. bicarinata*), being somewhat less than a half coil in length. The third chamber therefore begins earlier and it also is much shorter than in *S. bicarinata*, being but little more than a half coil in length. As a result, the fourth chamber which initiates the complete generic characters begins at a point a very little more than one coil beyond the apertural opening of the proloculum.

Other forms which have been usually grouped as *Spiroloculina* have a very different early development and will be considered after *Quinqueloculina* is taken up.

*Derivations from Spiroloculina.*—In the fossil forms especially there is a considerable development from *Spiroloculina* as a base. Uniserial developments take place in species usually assigned to *Articulina* but apparently do not belong to that genus. Another development is that seen in *Renulina* (figs. 10, 11) from the Eocene of the Paris Basin. Here is a genus apparently limited to the Eocene of the Paris Basin is a foraminifer, which in its general form is very like certain stages seen in the *Peneroplis* group, in *Orbiculina compressa* and *Orbitolites marginalis*. This form of test developed similarly in the various genera gives an excellent example of the parallelism that occurs in the foraminifera. In these cases the early development is different and the chambers differ internally even while exteriorly the same general form is developed.

The first four chambers of a specimen of *Renulina* are shown in figure 10. There is an oval proloculum (1) followed by a very short second chamber (2), shorter than that seen in any of the genera so far considered. This is but a quarter coil in length. Its wall is continuous with that of the proloculum and of the same thickness. It builds no floor on the surface of the proloculum. The third chamber (3) is long, making with the second chamber a complete coil. The

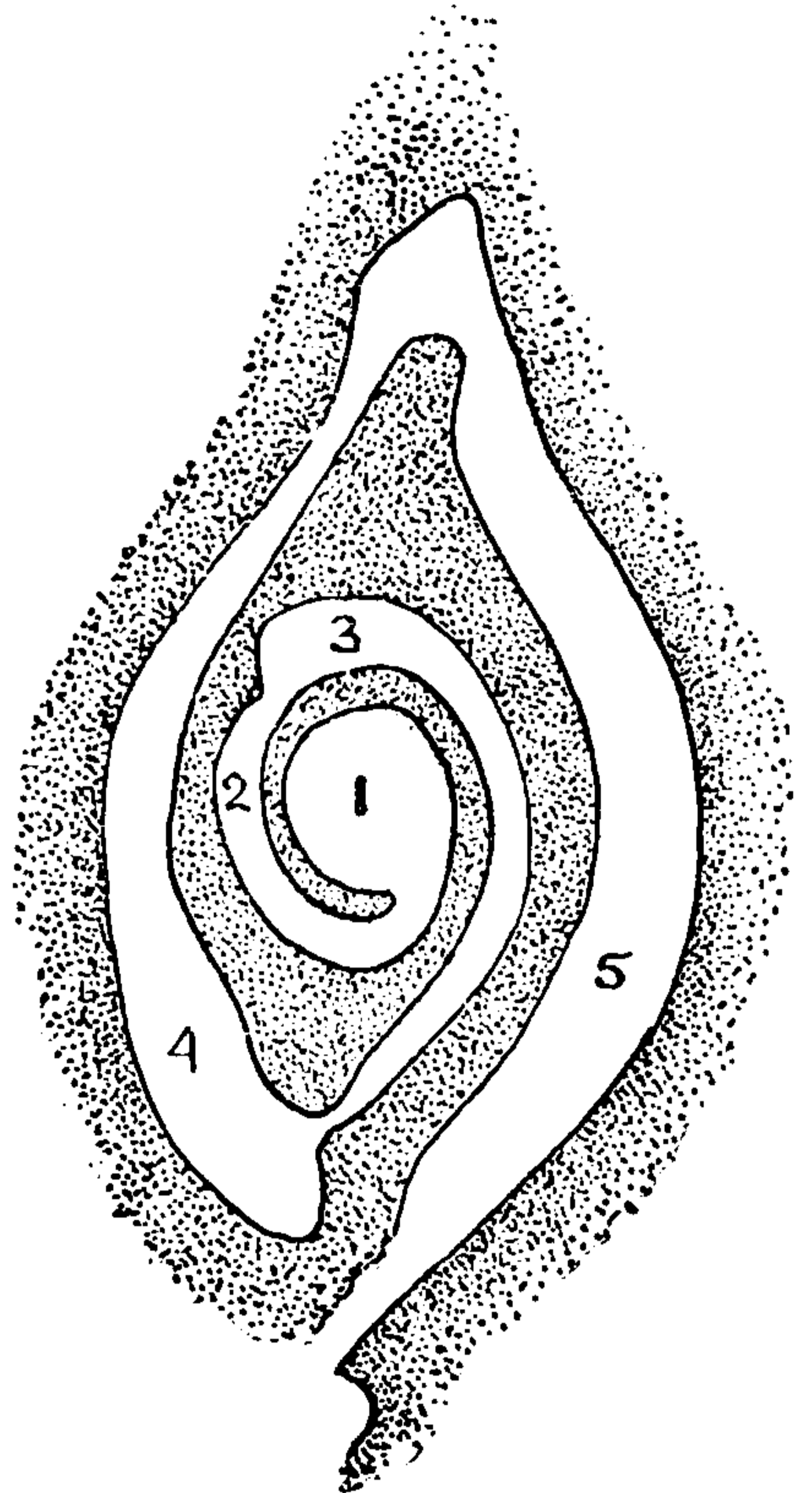

FIG. 9.—SPIROLOCULINA ALATA TERQUEM.  $\times 400$ . EOCENE OF VANDAN-COURT, PARIS BASIN. SPECIMEN SHOWING THE EARLY CHAMBERS VIEWED BY TRANSMITTED LIGHT. (1) PROLOCULUM, (2) SECOND CORNUSPIRALIKE CHAMBER, (3-5) CHAMBERS SHOWING THE TYPICAL HALF COIL LENGTH.

fourth chamber (4) is short, one third of a coil in length, increasing considerably in height at the apertural end while there is a thickened flaring lip. Chambers 5 and 6 (fig. 11) are also a third of a coil in length, making one complete coil with chamber 4. The seventh

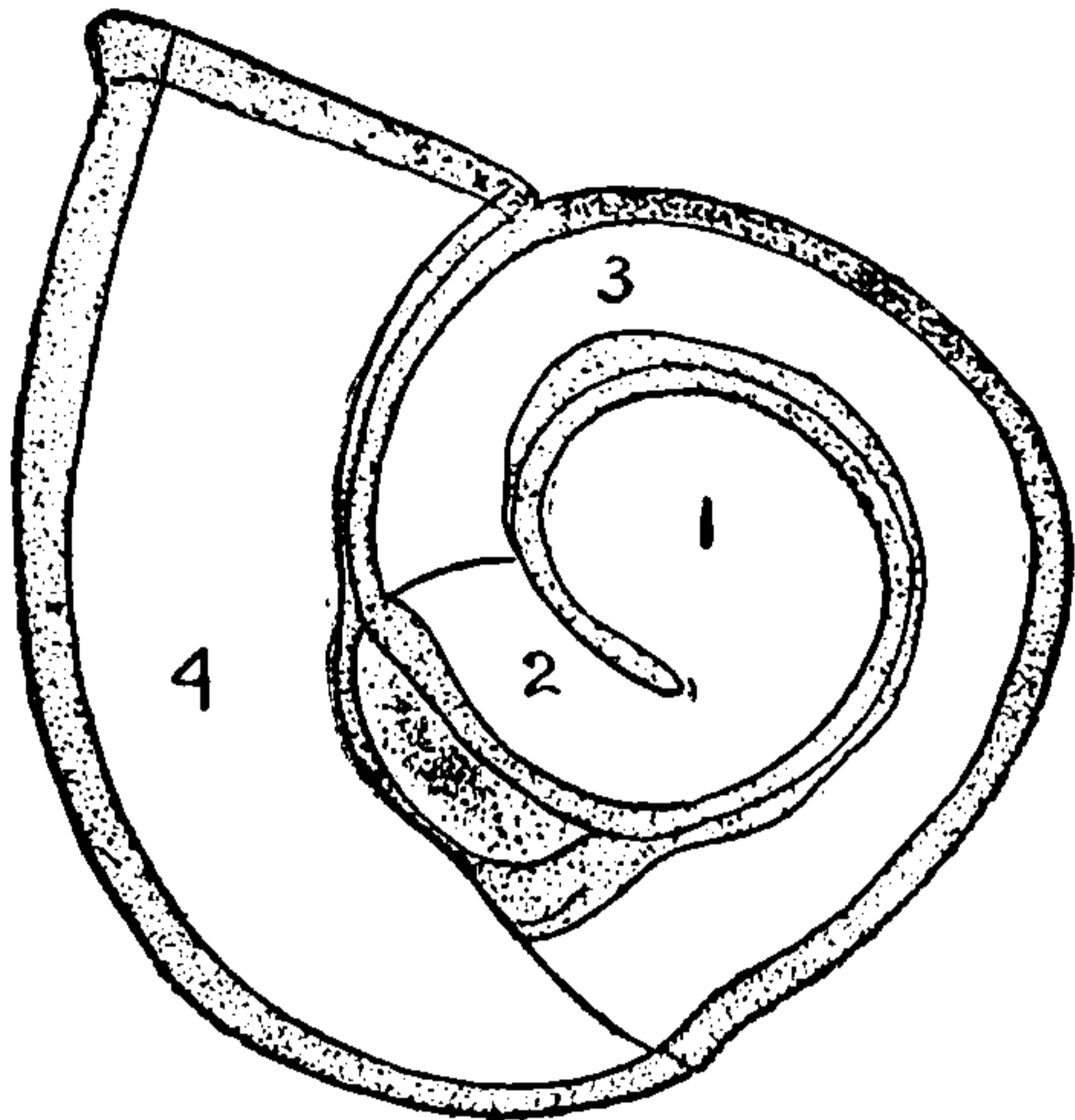

FIG. 10.—FIRST FOUR CHAMBERS OF A SPECIMEN OF *RENULINA* FROM THE EOCENE OF THE PARIS BASIN.  $\times 160$ .

chamber is similar. At this stage it is a closely coiled non-involute test, building the later chambers one-third of a coil in length.

Chamber 8 is very short in comparison with the preceding ones. Chamber 9 is also short but very much higher than earlier chambers, the outer wall taking a tangential direction. This tangential direction of the outer wall is continued in succeeding chambers, greatly increasing the height of the chambers which in all cases continue around to the preceding coil. This makes the form of test noted in forms of *Peneroplis*, *Orbiculina*, and *Orbitolites*, as already noted. This is brought about in the same mechanical way by the similar tangential position of the peripheral wall.

According to the published figures, in a later stage the chambers may extend back on both sides and form an extended chamber nearly meeting at opposite ends so that if continued slightly an annular growth would result. None of the series of specimens examined had reached this stage.

*Development of Quinqueloculina.*—*Quinqueloculina* and the various genera which are derived from it differ from all the other genera of the Miliolidae in having a plane of coiling which is constantly shifting with each newly added chamber, at least in the young. In all the genera so far considered the test has been planospiral.

As the genera next to be considered coil in more than one plane, a longitudinal section can not usually be made so as to show the true relation of all the chambers. For the study of these genera, transverse sections passing through the proloculum are absolutely essential. The excellent detailed figures given by Schlumberger have been freely drawn upon for the study of these structures.

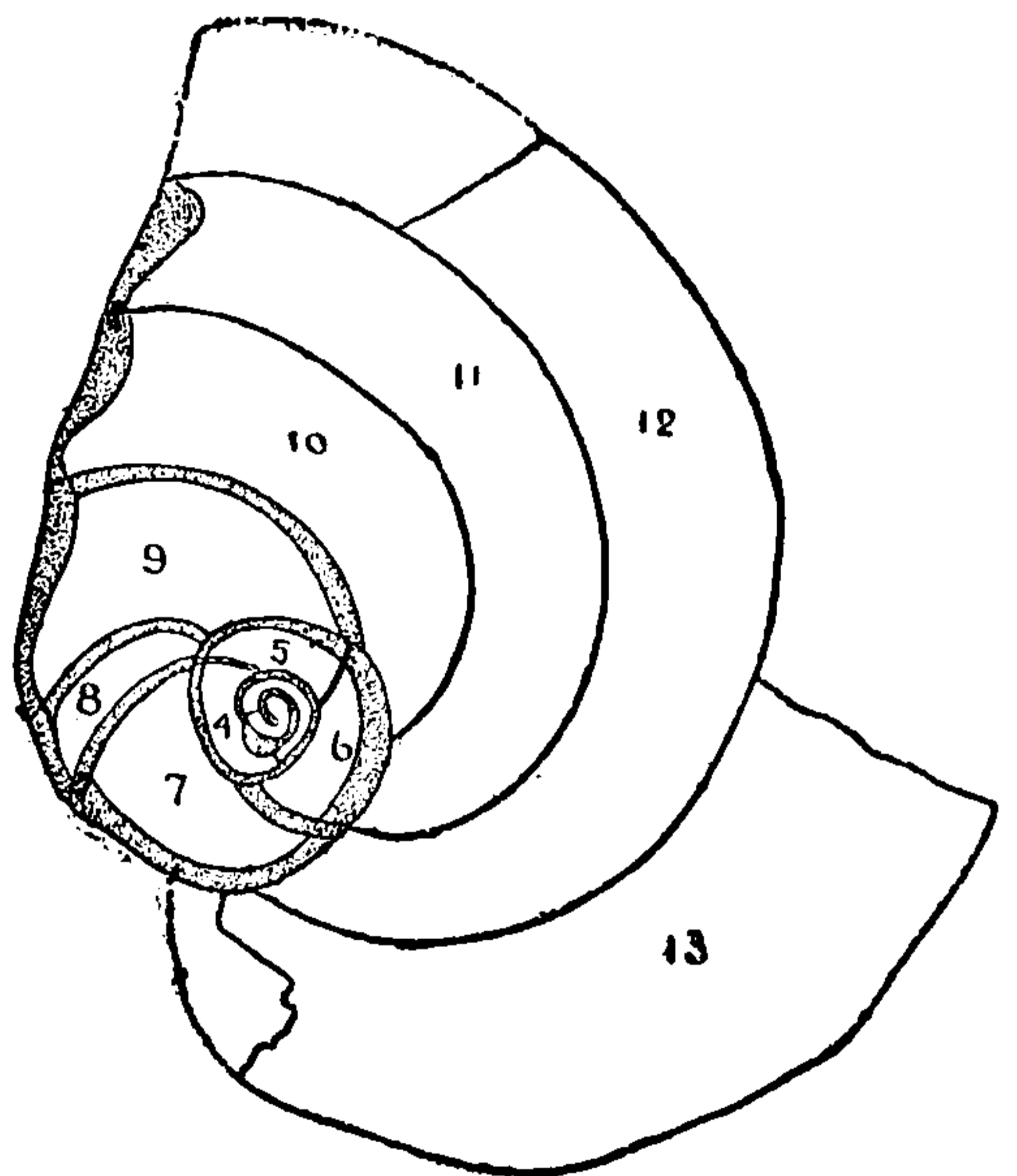

FIG. 11.—COMPLETE SPECIMEN OF *RENULINA*, THE EARLY CHAMBERS OF WHICH ARE SHOWN IN FIG. 10.  $\times 13$ .

In *Quinqueloculina* there is an oval proloculum varying in size in the two forms of the species, microspheric and megalospheric, as already noted. It is followed by an elongate chamber about half a coil in length, closely coiled about one side of the proloculum, and builds no floor. The wall of this second *Cornuspira*-like chamber is of the same thickness and continues with the proloculum.

A longitudinal section of the first two chambers of *Quinqueloculina suborbicularis* is shown in figure 12. This is of the same abbreviated *Cornuspira*-like type as the second chamber in various other genera already described.

The early development in *Quinqueloculina rugosa* d'Orbigny is shown in figure 13. The proloculum is circular in cross section and the second *Cornuspira*-like chamber being cut twice is shown on opposite sides of the proloculum at 2 and 2a. The third chamber, shown in cross section at 3, builds no floor, a character usually noted in this genus. Its outline in cross section is rounded and smooth. Its length, as is that of the succeeding chambers, is a half coil. Chamber 4 is added in another plane  $144^\circ$  of an arc from the position of its predecessor, chamber 3. Chamber 5 is added in a plane  $144^\circ$  from chamber 4, and so on for the sixth and seventh chambers. With the seventh chamber the generic character is attained, that of a test with five chambers visible from the exterior. Additional chambers are seen in figure 15. Chamber 8 is added in the same plane as chamber 3 and covers it; chamber 9 in the same plane as chamber 4, and so on. Succeeding chambers are added in planes  $144^\circ$  from one another, but the five planes in any one cycle are developed  $72^\circ$  of an arc from one another. This is similar in a general way to a  $2/5$  arrangement in the phyllotaxy of plants where succeeding leaves are developed  $144^\circ$  from one another, but the whole cycle of five leaves is made up of a series of radial planes  $72^\circ$  apart. In the vertical axis two and a half revolutions are made by five chambers, as each is a half coil in length, while in the horizontal axis two cycles are made before a chamber is added

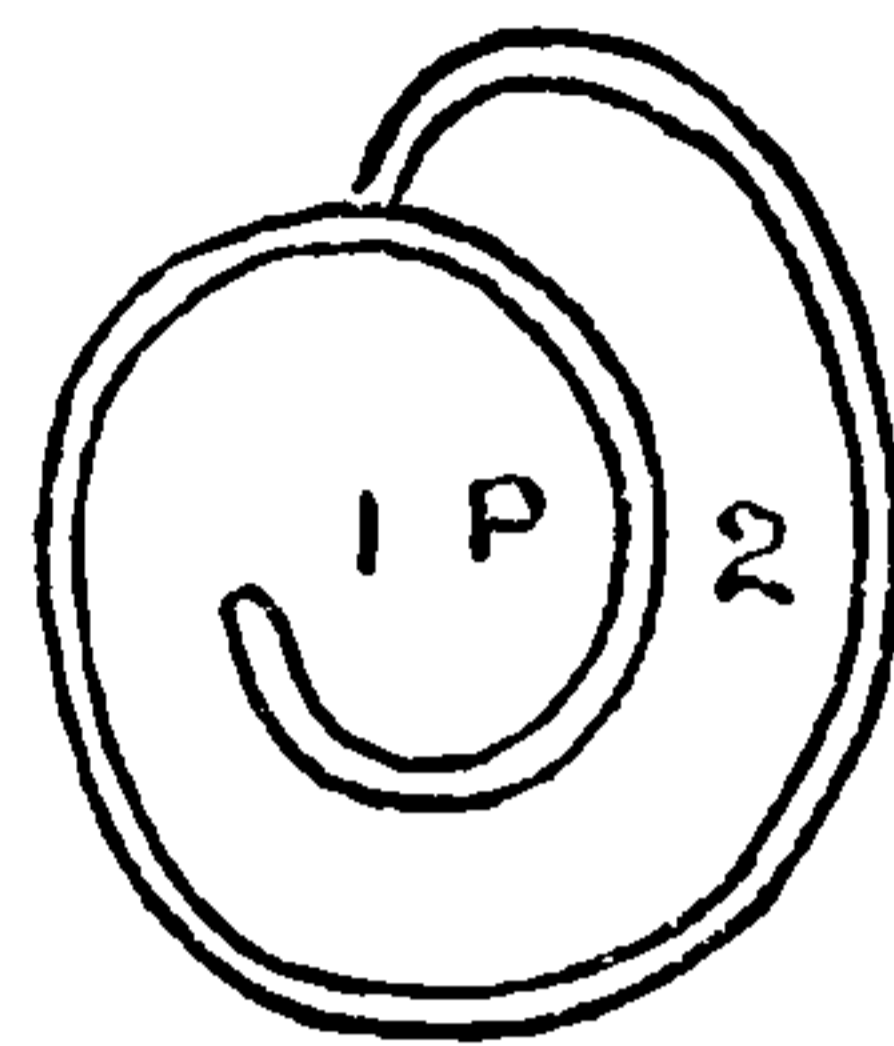

FIG. 12. — QUINQUELOCULINA SUBORBICULARIS D'ORBIGNY. SECTION OF YOUNG.  $\times 300$  (ADAPTED FROM SCHLUMBERGER). P. PROLOCULUM.

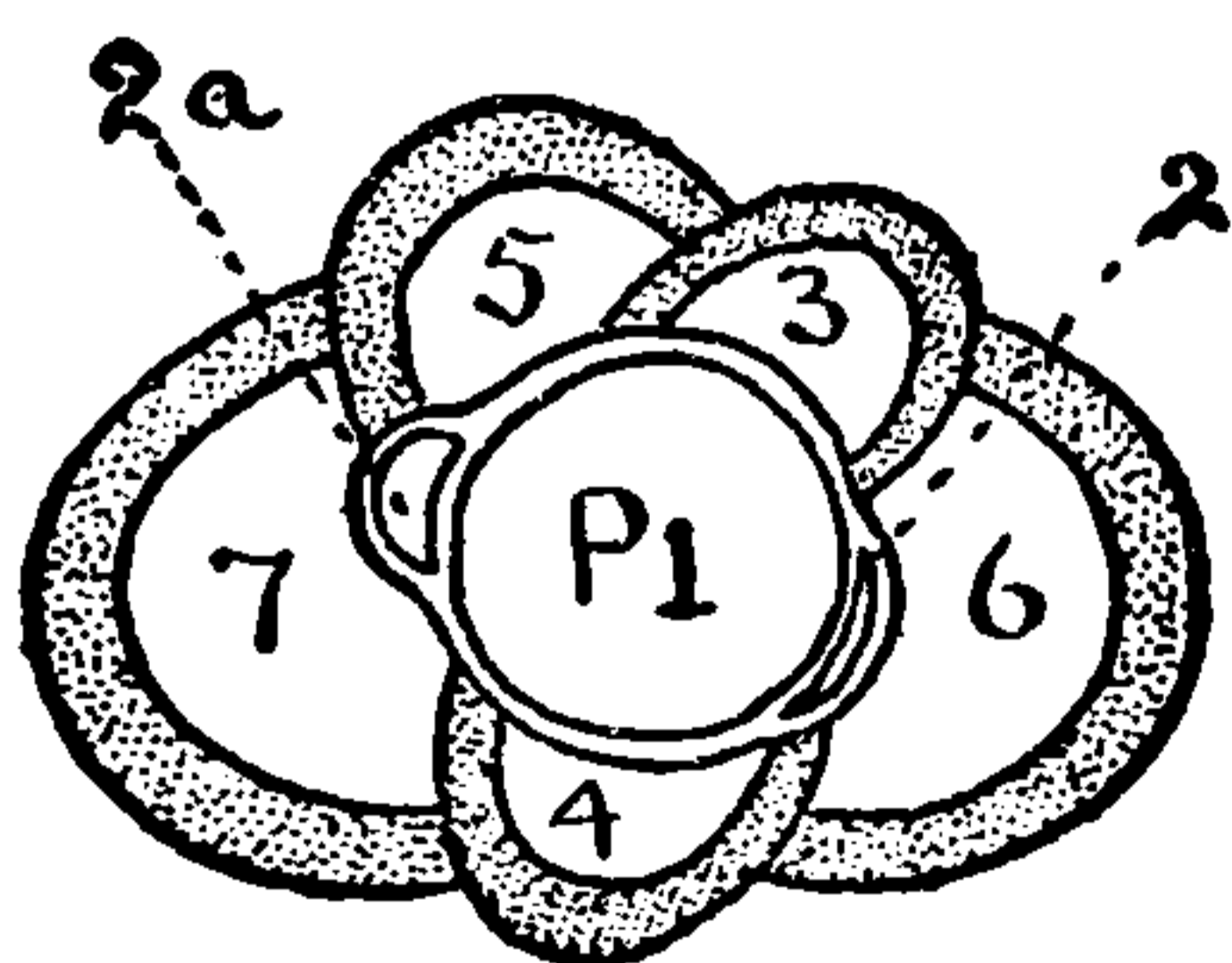

FIG. 13.—EARLY CHAMBERS OF QUINQUELOCULINA RUGOSA D'ORBIGNY.  $\times 300$  (ADAPTED FROM SCHLUMBERGER).

directly in the same plane as the last of the preceding series. In typical *Quinqueloculina*, then, after the seventh chamber each chamber is added directly outside its fifth preceding chamber. In *Quinqueloculina* the generic character is completed with this development, and in further growth simply an increase in size results from the addition of new chambers in this same series of planes. This character will be called "quinqueloculine" when seen in the young of other genera.

In various species of *Quinqueloculina* there is a progressive development in the ornamentation, the earlier formed chambers being

smooth and semi-elliptical in cross section as in the primitive chambers seen in the microspheric form throughout the genus. As shown in figure 14, there is a progressive development of ornamentation; in this case an increase in the number of costae from one in chamber 3 to a considerable number in chamber 13. In some individuals a definite senescent character is shown in the loss of these costae, and the resulting development of smooth chambers like that seen in its own young, the intermediate chambers as seen in section bearing distinct costae.

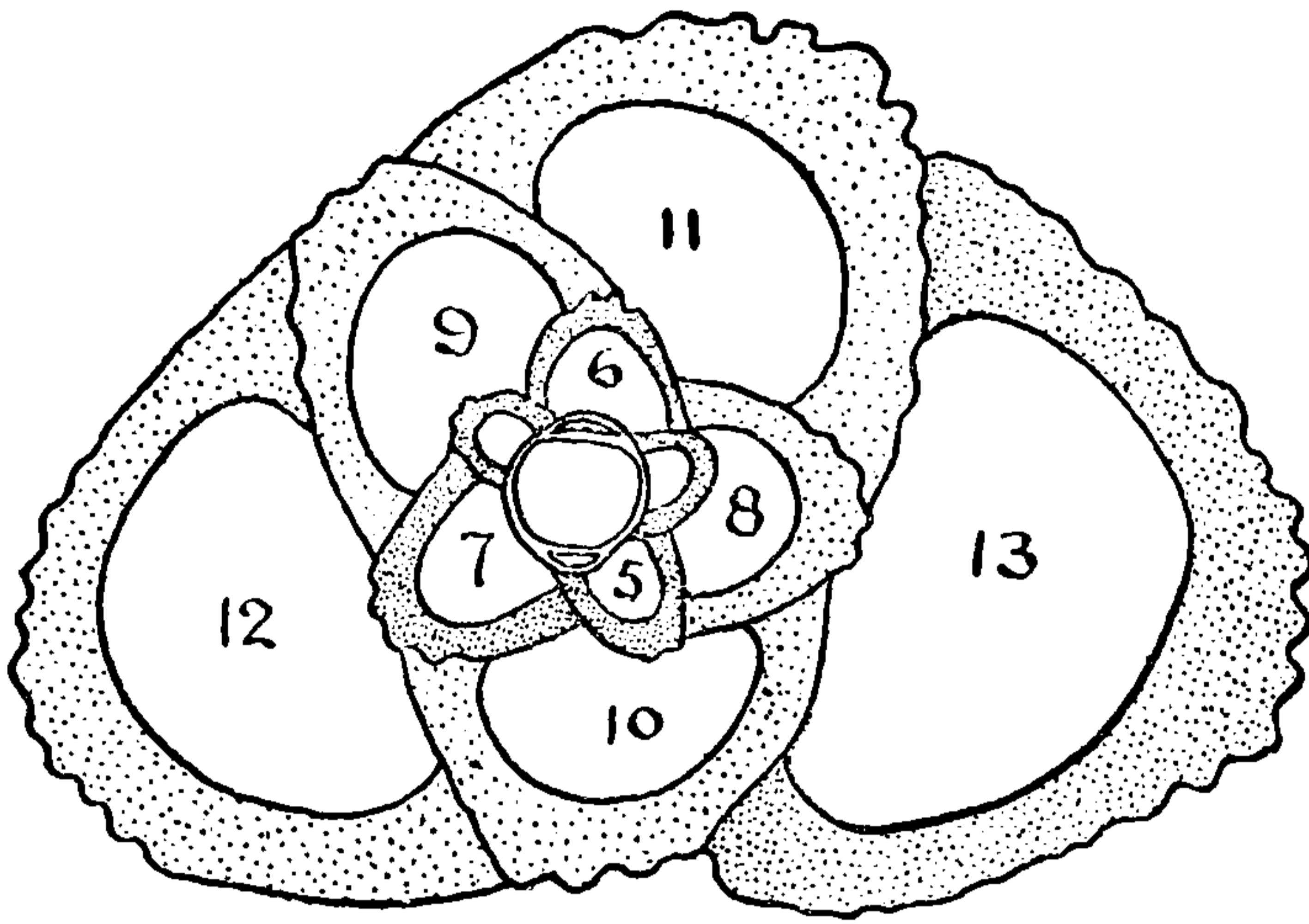

FIG. 14.—QUINQUELOCULINA UNDULATA D'ORBIGNY.  $\times 150$  (ADAPTED FROM SCHLUMBERGER). SHOWING PROGRESSIVE INCREASE IN ORNAMENTATION, THE NUMBERS OF COSTAE INCREASING IN NUMBER WITH NEW CHAMBERS.

There are both microspheric and megalospheric individuals developed in *Quinqueloculina*, but they differ only in the size of the proloculum and the total number of chambers in the adult, not in the general plan of their development. The fact that the complete stages in development shown by the microspheric form are not different from those of the accelerated megalospheric form may be taken as a definite indication that *Quinqueloculina* is a primitive form at the base of its own series. Succeeding genera discussed show added stages and a dropping out of certain of these in the megalospheric form. *Quinqueloculina* is considered as the primitive form from which the other genera of the quinqueloculine group have been derived by the addition of differential characters. The proof of this is the fact that they have a quinqueloculine stage in the young of at least their microspheric form.

In figure 16 is given a diagrammatic figure showing the character of chamber development in a typical *Quinqueloculina*. The five planes are lettered A to E and the chambers numbered 1 to 9. The arrows indicate the direction of the addition of new chambers in

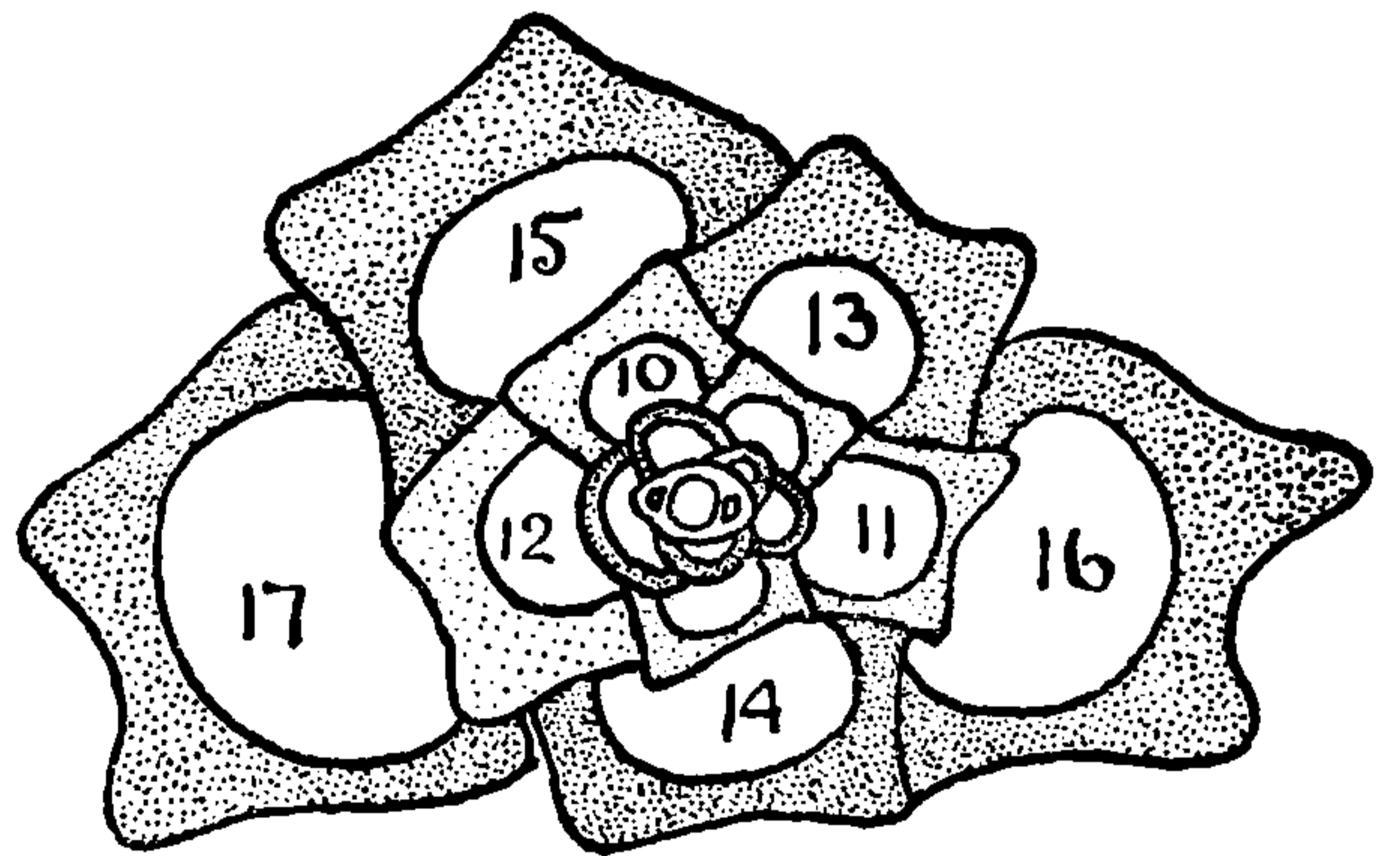

FIG. 15.—QUINQUELOCULINA RUGOSA D'ORBIGNY.  $\times 150$  (ADAPTED FROM SCHLUMBERGER). SHOWING PROGRESSIVE DEVELOPMENT OF CHARACTERS FROM THE EARLY SMOOTH ROUNDED CHAMBERS TO THE MUCH ANGLED AND PERIPHERALLY EXCAVATED CHAMBERS OF THE ADULT.

the cycle. In the figure chamber 3 is in the plane A; chamber 4,  $144^\circ$  from it, is in the plane B; chamber 5 in plane C; 6 in plane D; 7 in plane E; and 8 again in plane A, overlying chamber 3.

*Derivatives from Quinqueloculina.*—The later development from a quinqueloculine form may be seen in the regularly progressive series, *Triloculina*, *Biloculina*, etc., as will be considered later, but other genera may be considered as direct derivatives from a quinqueloculine stock. These, as in *Massilina* and *Hauerina*, may add chambers which are planospiral and comparable to *Spiroloculina*, except in the young or as in *Articulina*, where there is developed a uniserial later development with a quinqueloculine young. The development of *Massilina* in the two forms, microspheric and megalospheric, will give a good illustration of a typical derivative from *Quinqueloculina*.

*Massilina secans* d'Orbigny gives in simple stages the development of characters which make up the genus *Massilina* Schlumberger. From a study of the development of this species it will be seen that this genus is one derived from *Quinqueloculina* by

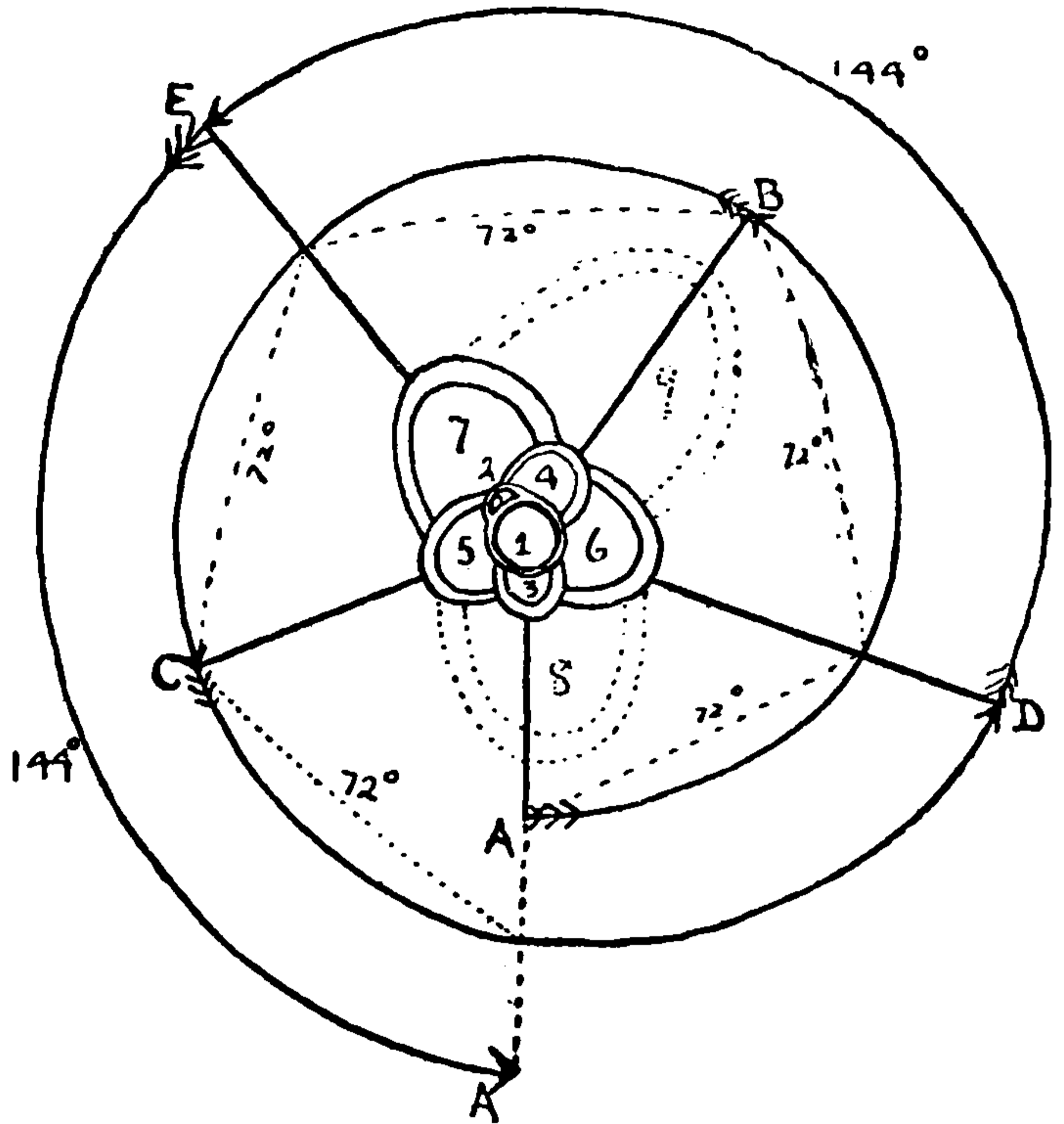
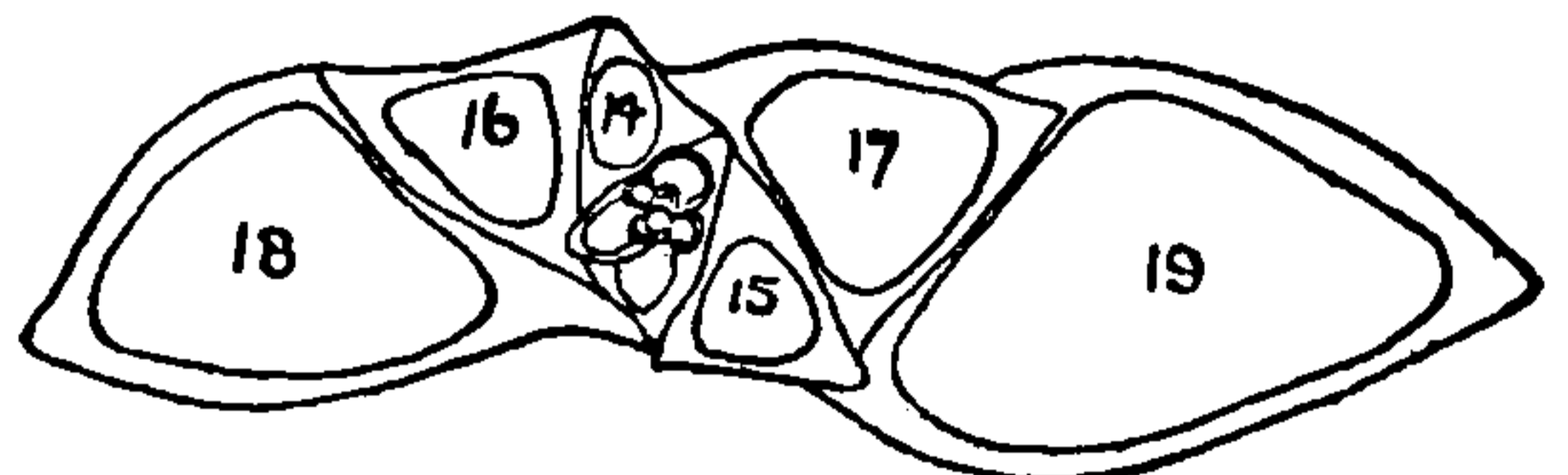
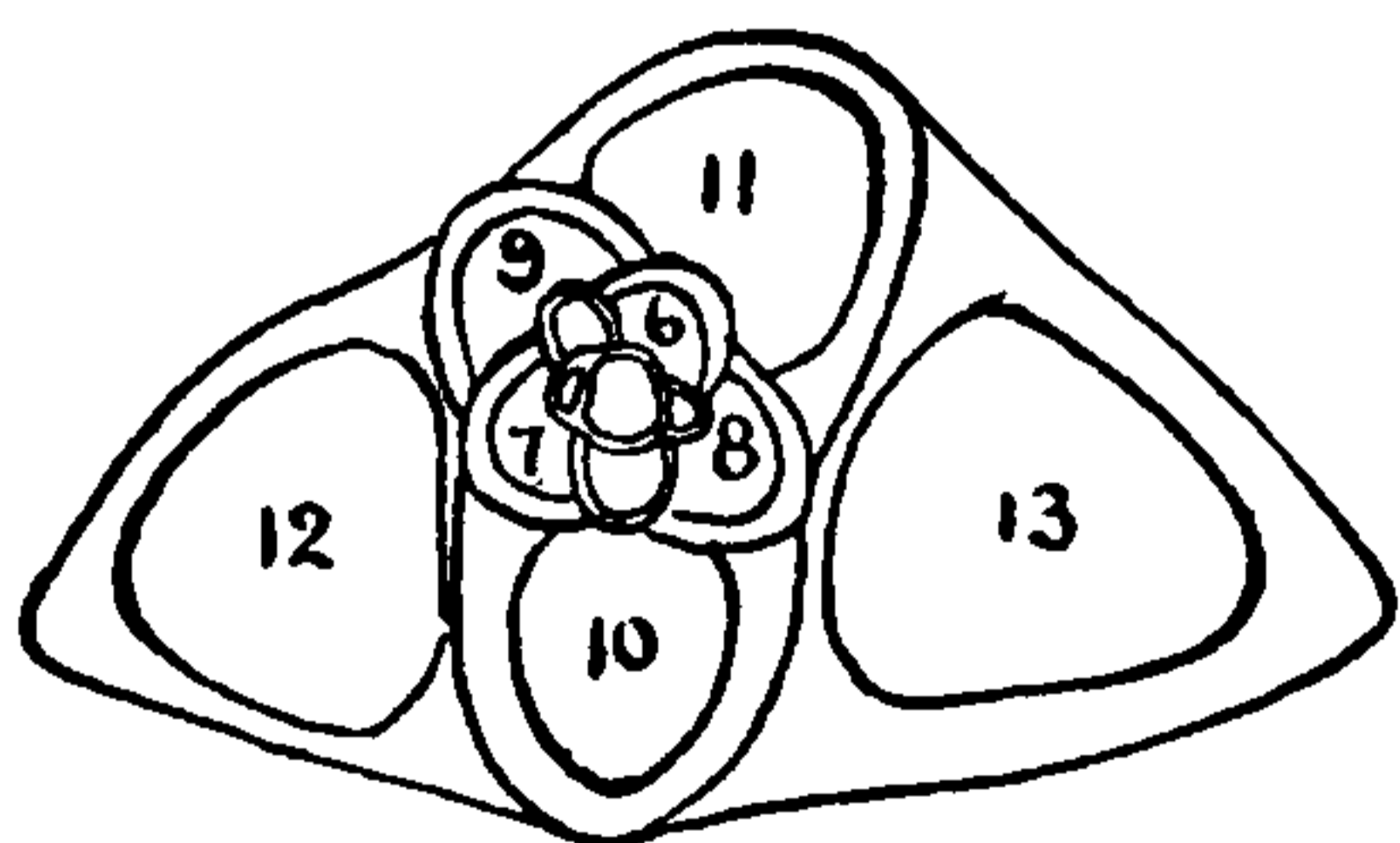

FIG. 16.—DIAGRAMMATIC SECTION OF QUINQUELOCULINA. A-E, PLANES IN WHICH CHAMBERS ARE ADDED. 1-9, CHAMBERS. ARROWS INDICATE THE DIRECTION OF ROTATION IN THE ADDITION OF CHAMBERS.



FIGS. 17, 18.—*MASSILINA SECANS* (D'ORBIGNY). 17, EARLY CHAMBERS OF MICROSPHERIC FORM.  $\times 115$ . 18, COMPLETE SPECIMEN.  $\times 13$  (ADAPTED FROM SCHLUMBERGER).

the addition of definite differential characters. Both the forms, those with a microspheric and megalospheric proloculum, have been found by Schlumberger. The early chambers of a specimen with a microspheric proloculum are shown in figure 17. There is a small proloculum followed by the usual *Cornuspira*-like chamber making a

little more than a half coil in length. This chamber is shown cut once on the left side of the proloculum. The succeeding chambers, 3 to 13, are arranged on a quinqueloculine plan of growth, the chambers as added being in planes  $144^\circ$  from one another, five chambers thus appearing on the periphery in planes  $72^\circ$  from one another. In the adult, figure 18 of the same microspheric form, the quinqueloculine growth is seen to continue to the seventeenth chamber. The eighteenth and nineteenth chambers, instead of continuing the quinqueloculine plan of growth, are placed in planes nearly  $180^\circ$  from one another and initiate the adult character, that of chambers in an open coil lying in one plane.

A young individual of the megalospheric form is shown in figure 19. Without the last developed chamber, No 12, it would be taken for a young *Quinqueloculina*. There is a large proloculum followed by a second chamber of the usual *Cornuspira*-like form. Chambers 3 to 11 are arranged on the typical quinqueloculine plan as in the microspheric form already noted. Chamber 12, however, is added in a plane nearly  $180^\circ$  and from chamber 11 initiates the adult charac-

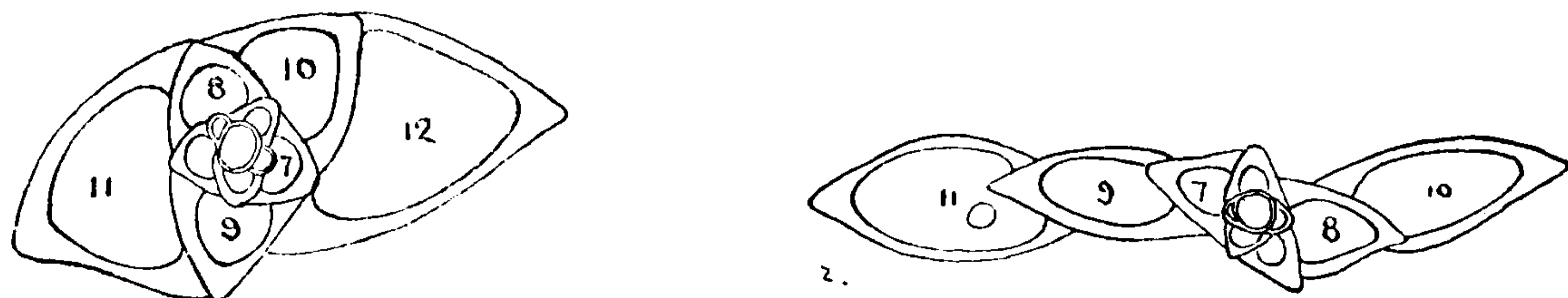

FIGS. 19, 20.—*MASSILINA SECANS* (D'ORBIGNY). MEGALOSPHERIC FORM (ADAPTED FROM SCHLUMBERGER).  
19, YOUNG SPECIMEN STILL IN QUINQUELOCULINE STAGE.  $\times 20$ . 20, ADULT SPECIMEN.  $\times 13$ .

ter. This specimen is then more accelerated than the microspheric specimen, figure 18, as it takes on this character several chambers earlier than did the microspheric. An adult specimen of the megalospheric form showing greater acceleration is shown in figure 20. Here the proloculum is nearly twice as large in the previous megalospheric specimen. Chambers 3 to 7 are arranged on the quinqueloculine plan, but chamber 8 is added in a plane  $180^\circ$  from chamber 7, thus initiating the adult character very early. This character did not appear in the other megalospheric specimen until the twelfth chamber and in the microspheric until the eighteenth chamber; chambers 8 to 11 are in an open coil in one plane, completing the development, while in both of the other specimens it was still in the quinqueloculine stage in the eleventh chamber.

As noted in other species, the microspheric form attains the largest size, as seen by comparing the two figures, figure 18 and figure 20, which are drawn with the same magnification. In the microspheric form, figure 18, there have been but two *Massilina* chambers built,

while in figure 20, the megalospheric, four such chambers exist, yet the two specimens are of about the same diameter.

There is a tendency, especially in the microspheric form, to build a floor in the later chambers. In this specimen this character is taken on in the twelfth chamber and continued throughout the further growth.

*Development of Triloculina.*—A section of the test of *Triloculina schreibariana* d'Orbigny with a microspheric proloculum is shown in figure 21. There is the usual form of proloculum followed by a *Cornuspira*-like second chamber. Chambers 3 to 10 are arranged on a quinqueloculine plan and the test is like *Quinqueloculina* at this stage. The chambers lie in planes  $72^\circ$  apart, but successively added chambers  $144^\circ$  from one another as in *Quinqueloculina*. Later chambers, 11 to 16, are arranged on a different plan, each chamber being added in a plane  $120^\circ$  from its preceding one, giving a test with but three chambers visible on the surface. The method of building here is a series of chambers made up of single cycles, in each of which each chamber lies on the outer side of its third preceding chamber instead of the fifth, as in *Quinqueloculina*. This method of growth may be

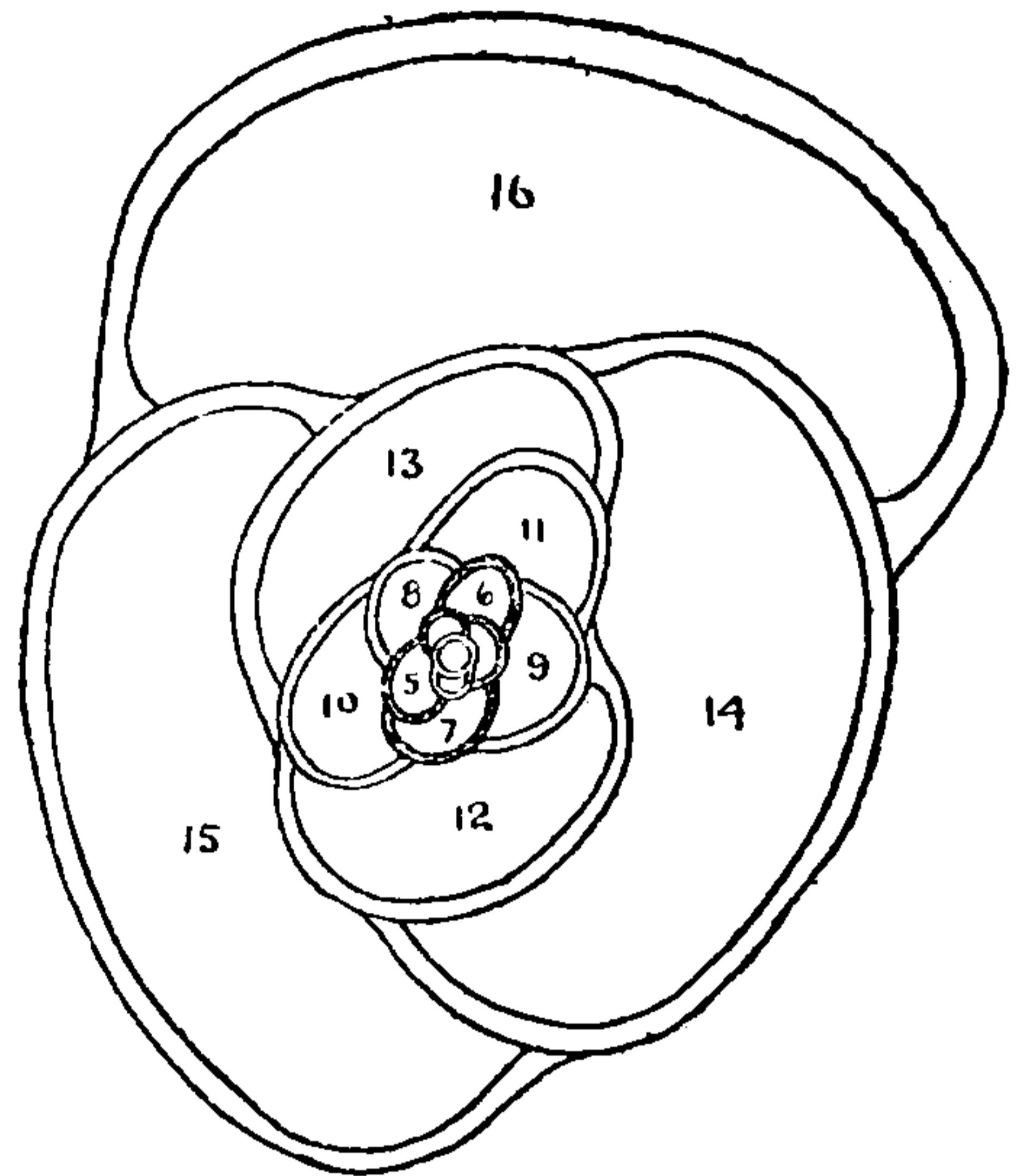

FIG. 21.—CHAMBERS OF MICROSPHERIC SPECIMEN OF *TRILOCULINA SCHREIBERIANA* D'ORBIGNY (ADAPTED FROM SCHLUMBERGER).  $\times 33$ . QUINQUELOCULINE CHAMBERS ARE SHADED IN THE FIGURE.

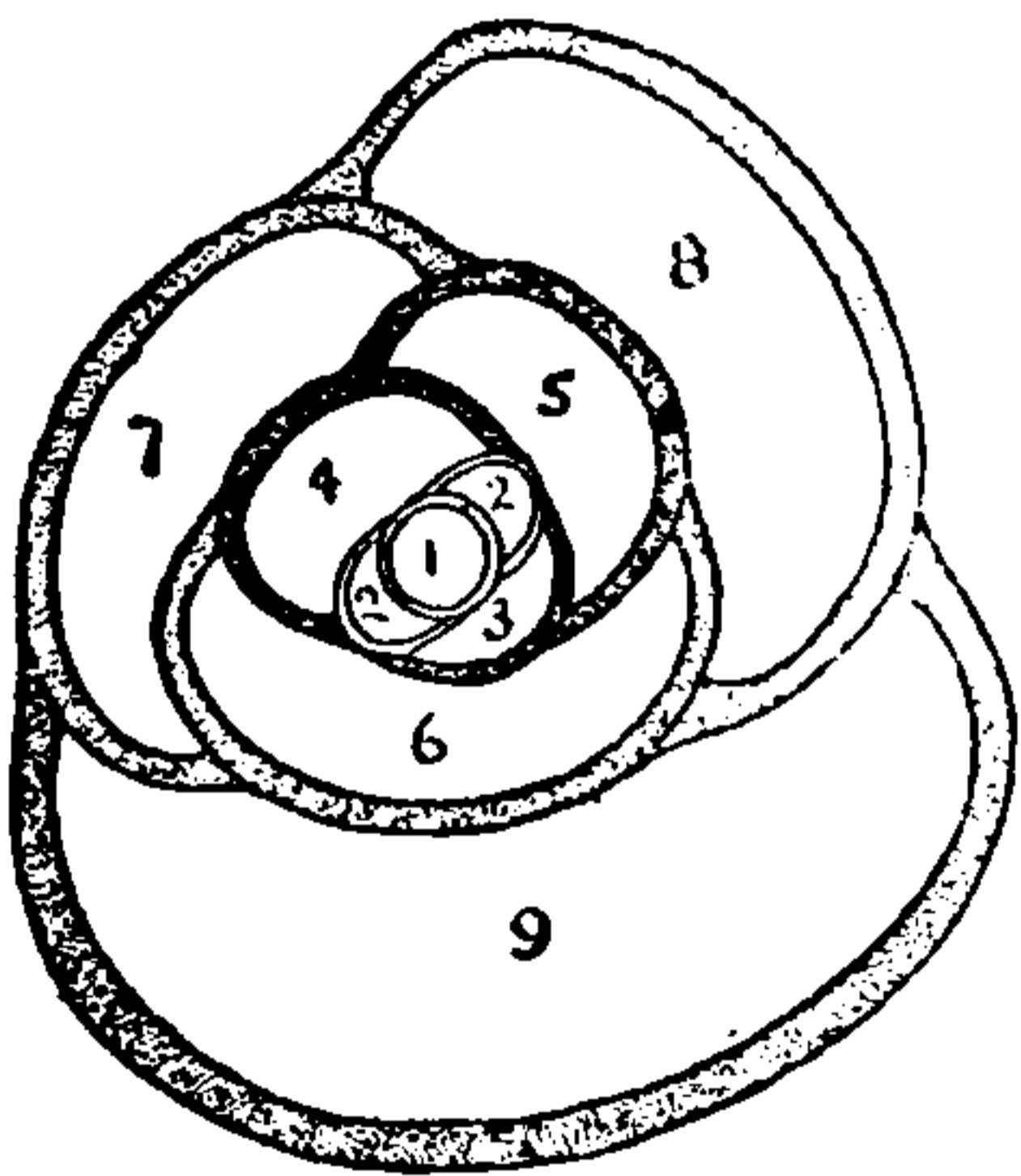

FIG. 22.—EARLY CHAMBERS OF MEGALOSPHERIC SPECIMEN OF *TRILOCULINA SCHREIBERIANA* D'ORBIGNY (ADAPTED FROM SCHLUMBERGER).  $\times 66$ .

called triloculine from the generic name *Triloculina*, this character being typical of the adult of that genus. The stages made out in the microspheric form of *Triloculina* are four—(1) proloculum, (2) *Cornuspira*-like chamber, (3) quinqueloculine chambers, (4) triloculine chambers.

A section of megalospheric specimen of this same species is shown in figure 22. Here there is a large proloculum followed by a second chamber cut in two at opposite points in the section. The following three chambers, 3 to 5, are somewhat irregularly placed, but the number of degrees covered is about  $275^\circ$ , which gives an average of about  $138^\circ$  for each angle. This is closed to the  $144^\circ$  of a typical *Quinqueloculina*, and these three chambers represent the quinqueloculine stage in the development. These chambers, 3 to 5, form a reduced quinqueloculine stage, which does not even form a complete series. This is much more accelerated than the microspheric specimen, where there were eight chambers built on the quinqueloculine plan. Chambers 6 to 9 are arranged in a triloculine plan, being added in

planes  $120^\circ$  from one another. The megalospheric form is thus more accelerated, taking on the triloculine character in the sixth chamber, a character not initiated in the microspheric specimen until the eleventh chamber.

It will then be seen that the megalospheric form completed its growth with the ninth chamber, but the microspheric specimen in its ninth had not even attained the adult triloculine character. In matter of size the megalospheric specimen, with its eighth chamber, had built a test of about the same size as the microspheric specimen with 16 chambers.

*Development of Biloculina.*—A section of *Biloculina ringens* in the horizontal plane is shown in figure 23. This specimen has a microspheric proloculum followed by a *Cornuspira*-like second chamber of the usual sort in this group, a half coil in length thus being cut at but one point in the section. Chamber 3 starts a quinqueloculine stage continued through chamber 8 of the usual arrangement seen in *Quinqueloculina*, chambers  $72^\circ$  apart but successively added in radial planes  $144^\circ$  apart, as shown in the adult of *Quinqueloculina* and in the young of *Triloculina*. Chamber 9 initiates the triloculine stage, and with chambers 10 and 11 completes a cycle of chambers  $120^\circ$  apart. This triloculine stage is here continued through chamber 14. Chamber 15 initiates the biloculine stage where chambers are added in planes  $180^\circ$  from one another, the newly added chamber covering all except the last previously formed chamber. Thus in typical *Biloculina* but two chambers are visible from the exterior. Further growth is an increase in size by the addition of new chambers on this biloculine plan, the number of these chambers depending largely upon the age of the individual.

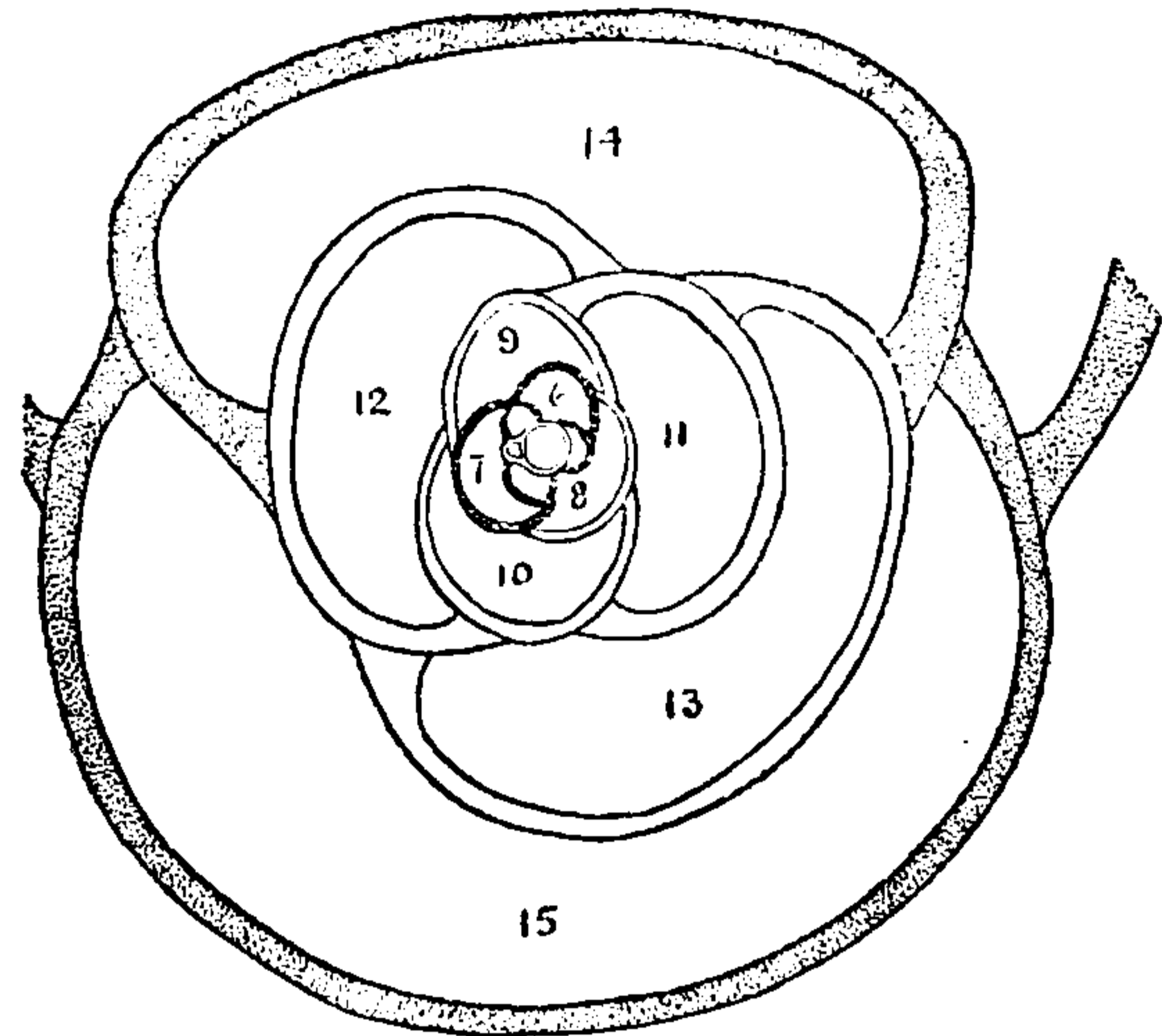

FIG. 23.—BILOCULINA RINGENS. EARLY CHAMBERS OF MICROSPHERIC FORM (ADAPTED FROM SCHLUMBERGER).  $\times 50$ . THE EARLY QUINQUELOCULINE CHAMBERS ARE SHOWN WITH DARK SHADING. THE LATER TRILOCLINE STAGE UNSHADED AND THE FINAL BILOCULINE CHAMBERS IN A LIGHT SHADING.

Chamber 3 starts a quinqueloculine stage continued through chamber 8 of the usual arrangement seen in *Quinqueloculina*, chambers  $72^\circ$  apart but successively added in radial planes  $144^\circ$  apart, as shown in the adult of *Quinqueloculina* and in the young of *Triloculina*. Chamber 9 initiates the triloculine stage, and with chambers 10 and 11 completes a cycle of chambers  $120^\circ$  apart. This triloculine stage is here continued through chamber 14. Chamber 15 initiates the biloculine stage where chambers are added in planes  $180^\circ$  from one another, the newly added chamber covering all except the last previously formed chamber. Thus in typical *Biloculina* but two chambers are visible from the exterior. Further growth is an increase in size by the addition of new chambers on this biloculine plan, the number of these chambers depending largely upon the age of the individual.

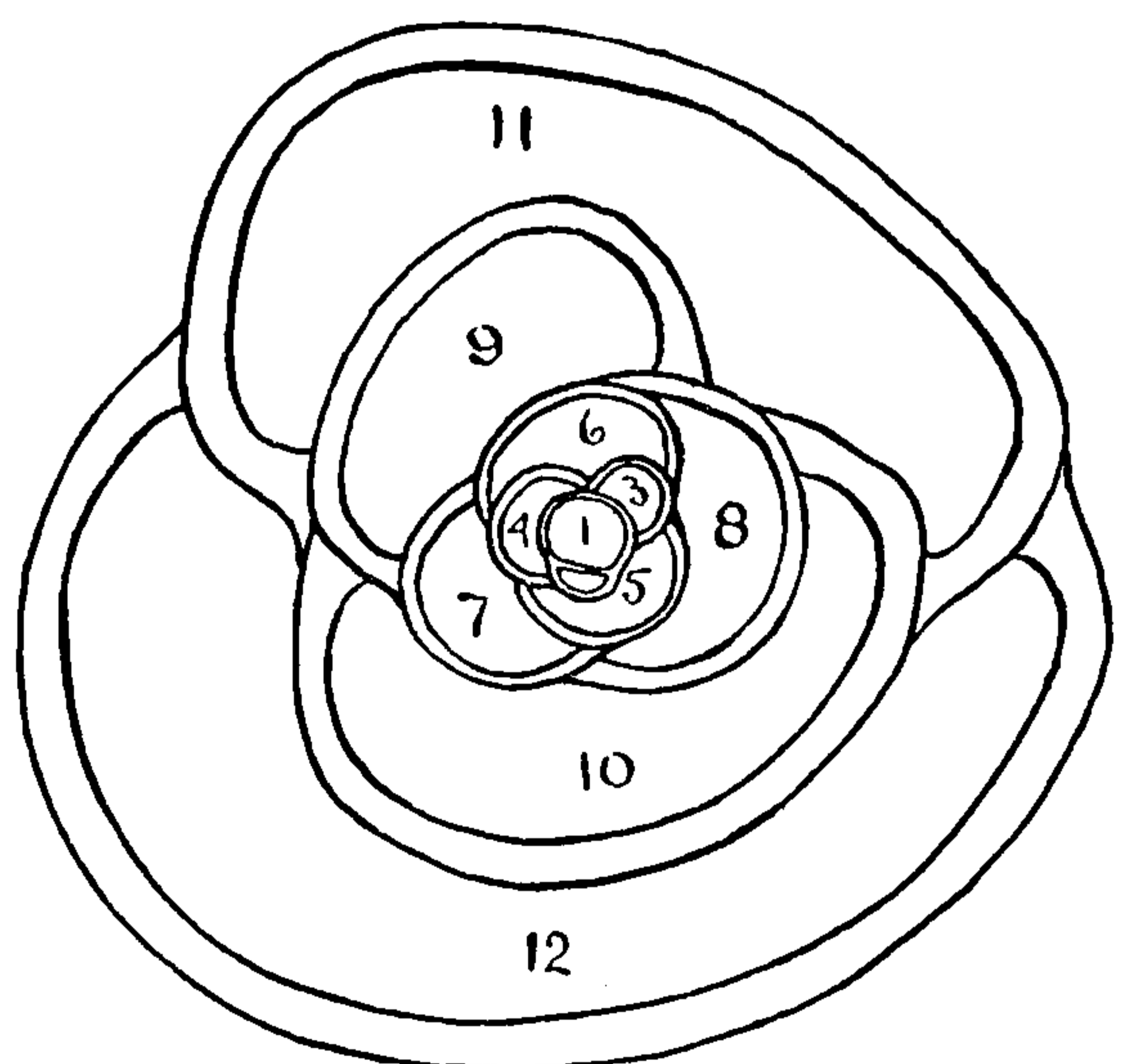

FIG. 24.—MEGALOSPHERIC SPECIMEN OF BILOCULINA RINGENS.  $\times 80$  (ADAPTED FROM SCHLUMBERGER).

In its microspheric form, then, *Biloculina* develops a proloculum and *Cornuspira*-like second chamber, followed successively by cham-



bers arranged on quinqueloculine and triloculine planes followed in the adult by chambers arranged on biloculine planes. A microspheric specimen of this species of *Biloculina* repeats in its own ontogeny characters seen in the adults of the more primitive types, *Cornuspira*, *Quinqueloculina*, and *Triloculina* in the order in which they were developed, as has already been noted in the ontogeny of those genera.

In specimens of various species of *Biloculina* where there is a megalospheric proloculum there is an accompanying acceleration of development as shown in figure 24, which is a section of *B. ringens* of the megalospheric form. A proloculum and *Cornuspira*-like second chamber form the first and second stages. Next, instead of a quinqueloculine stage, a triloculine stage is at once taken on by chamber 3 and continued through chamber 10. The angle between the chambers is rather constant, averaging  $120^\circ$ , except that between chambers 9 and 10 where the change from the  $120^\circ$  of triloculine to the  $180^\circ$  of biloculine growth occurs. There the angle is a medium between these two, as is also that between chambers 10 and 11. The biloculine stage starts definitely with chamber 11. This megalospheric specimen is then more accelerated than the microspheric, skipping the early quinqueloculine stage and taking on the adult biloculine plan of growth in chamber 11, not reached in the microspheric specimen until the fifteenth chamber.

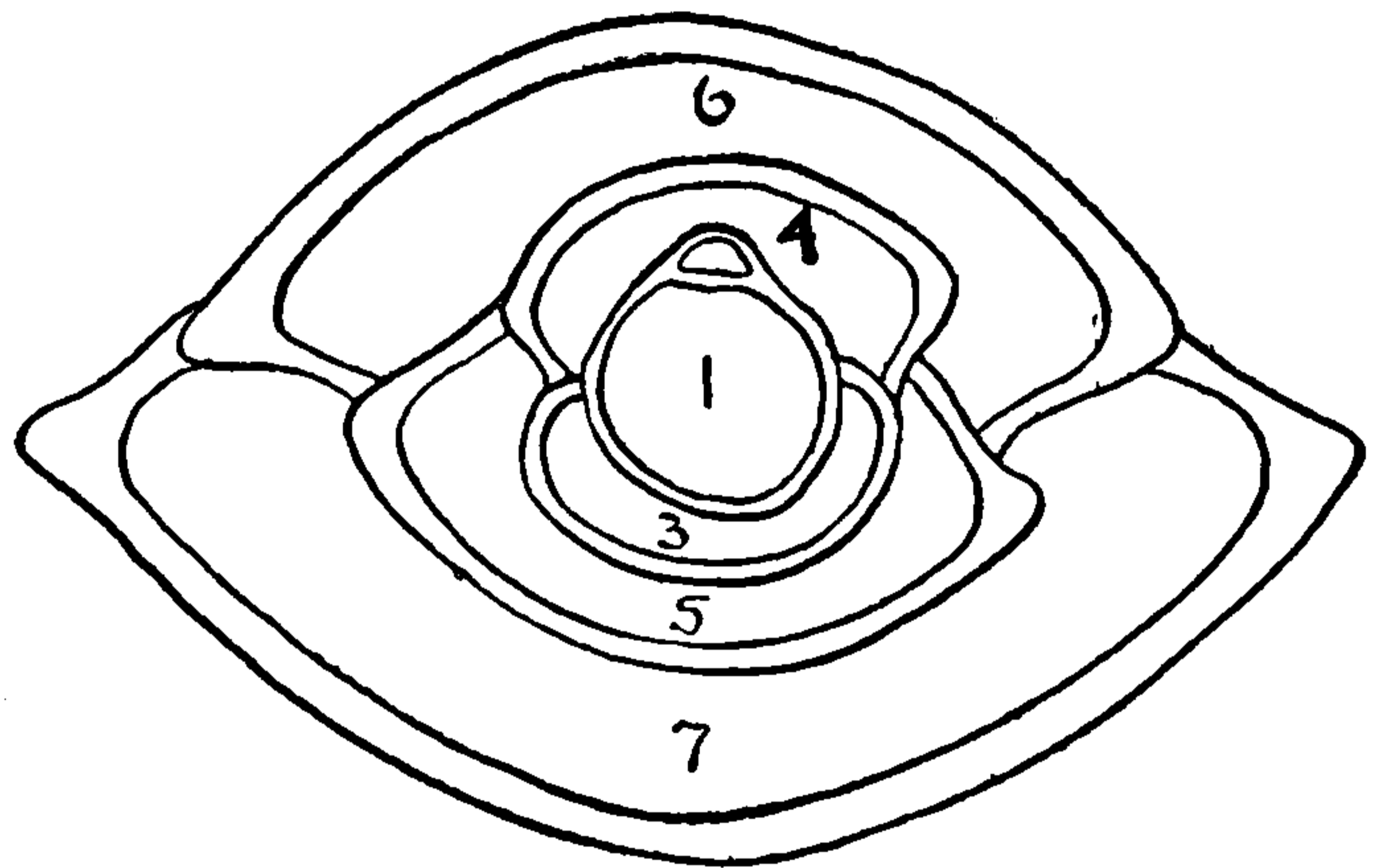

FIG. 25.—MEGALOSPHERIC SPECIMEN OF *BILOCULINA MURRHYN*A, WITH THE BILOCULINE STAGE BEGUN AT ONCE, THE QUINQUELOCULINE AND TRILOCULINE STAGES BEING SKIPPED.  $\times 200$  (AFTER SCHLUMBERGER).

A section of a specimen of *Biloculina murrhyna* with an exceptionally large megalospheric proloculum is shown in figure 25. The proloculum is very large and the *Cornuspira*-like second chamber small in comparison. Chambers 3 and 4, instead of forming the beginning of a quinqueloculine stage or even the triloculine stage as in the preceding here begin directly upon the biloculine character, the quinqueloculine and triloculine stages having been entirely skipped.

*Development of Idalina.*—The genus *Nevillina* as shown in the figures on plate 35, after Sidebottom, shows that we have here a genus in the present seas going a stage beyond *Biloculina* and developing almost a single chamber externally in the adult. In the fossils, however, even better examples occur. In *Idalina*, a genus from the Upper Cretaceous of Southern Europe, the highest type of devel-

opment in the quinqueloculine group is shown. *Idalina antiqua* Munier-Chalmas and Schlumberger occurs in the two forms, one with a microspheric, the other with a megalospheric proloculum. The figures used are taken from those of the two authors mentioned. The development of a specimen with a microspheric proloculum is shown in figure 26. There is a globular proloculum followed by a short *Cornuspira*-like chamber as the second stage in development. Following the second, chambers 3 to 23, inclusive, are arranged on a quinqueloculine plan of chambers in radial planes  $144^\circ$  from one another. This relation of the chambers is not always apparent from the position of the successive chambers, as there may be a considerable departure from the typical angle in individual chambers,

but the average of the angles of the planes during this quinqueloculine stage is always close to  $144^\circ$ .

Two sections figured by Schlumberger were measured as to the angles between successive chambers during the quinqueloculine stage. In one case the average of 11 angles was  $137^\circ$ ; in the other the average of eight angles was  $142^\circ$ . While these early chambers were not as uniformly arranged as in adult *Quinqueloculina*, the average is very close. Following

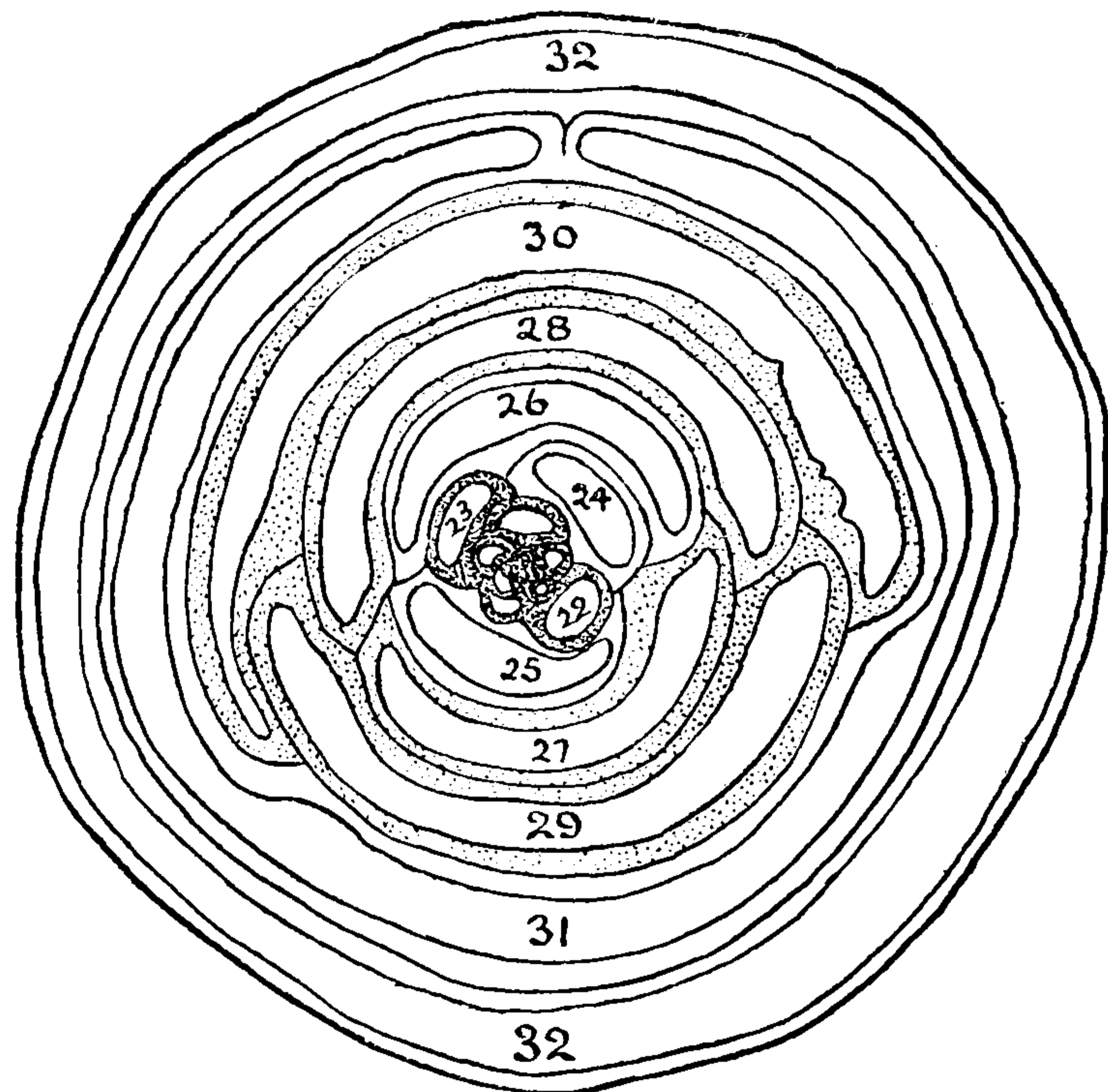

FIG. 26.—SECTION OF A MICROSPHERIC SPECIMEN OF *IDALINA ANTIQUA*.  $\times 25$  (AFTER MUNIER-CHALMAS AND SCHLUMBERGER). EARLY QUINQUELOCULINE STAGE, CHAMBERS 3-23 SHOWN IN DARK SHADING, TRILOCULINE STAGE, 24-26, UNSHADED; BILOCULINE STAGE, 27-30, IN LIGHT SHADING; UNILOCULINE STAGE, 31, 32, UNSHADED.

the quinqueloculine stage chambers are developed, arranged on a triloculine plan, the chambers added in radial planes  $120^\circ$  from one another. In the larger figure chamber 24 is  $115^\circ$  from the plane of chamber 23; chamber 25 is  $130^\circ$  from the plane of chamber 24—an average of  $122.5^\circ$  for these two chambers. In another section of *Idalina* two chambers in a similar situation gave  $124^\circ$  and  $123^\circ$ , respectively.

Following the triloculine stage the angle of the planes of addition increase until  $180^\circ$  is attained. There is usually one chamber which bridges over this gap between  $120^\circ$  and  $180^\circ$ , or between the triloculine and biloculine stages, the chamber not fully referable to either plan. In figure 26, for example, the angle between chambers

25 and 26 is about  $156^\circ$ , that between succeeding chambers being about  $180^\circ$ , so that chamber 25 is more than triloculine and less than biloculine. In another of Schlumberger's figures the relation of the change between triloculine and biloculine stages is still more graphically shown, the angles of chambers after the quinqueloculine stage measuring  $124^\circ$ ,  $123^\circ$ ,  $150^\circ$ , and  $180^\circ$ , respectively. The first two are distinctly triloculine and the last one is distinctly biloculine, the next to the last bridging over the gap almost exactly, the  $150^\circ$  of the angle being exactly halfway between the ideal triloculine angle of addition of chambers,  $120^\circ$ , and that of biloculine addition,  $180^\circ$ . As a rule, the triloculine stage in *Idalina* seems to be short and fewer in number of its chambers than either the preceding quinqueloculine stage or the succeeding biloculine stage, only three chambers being usually arranged on the triloculine plan.

Following the triloculine stage there is developed a definite biloculine stage with chambers added in planes  $180^\circ$  from one another. In the specimen figured there are five such chambers, 26 to 30, inclusive. Following the biloculine stage chambers are added which completely encircle the previously formed chambers so that but one chamber is seen from the exterior. This completes the development and is a stage higher than seen in living members of the Miliolidae except possibly *Nevillina coronata* (Millett).

A section of a specimen of *Idalina antiqua* with a megalospheric proloculum is shown in figure 27. The proloculum is much larger than in the microspheric form, but not as large as in certain other specimens next considered. Following the proloculum is the *Cornuspira*-like second chamber. The third stage is represented by chambers 3 to 10, inclusive, arranged on a quinqueloculine plan, in planes  $144^\circ$  apart as added. The fourth stage is formed by chambers 11 to 13, arranged on a triloculine plan, in planes  $120^\circ$  apart. Chamber 14 initiates the biloculine stage, not developed in the microspheric specimen until the twenty-seventh chamber. The uniloculine stage had not been attained in the specimen figured, the last-formed chamber, No. 17, being still biloculine.

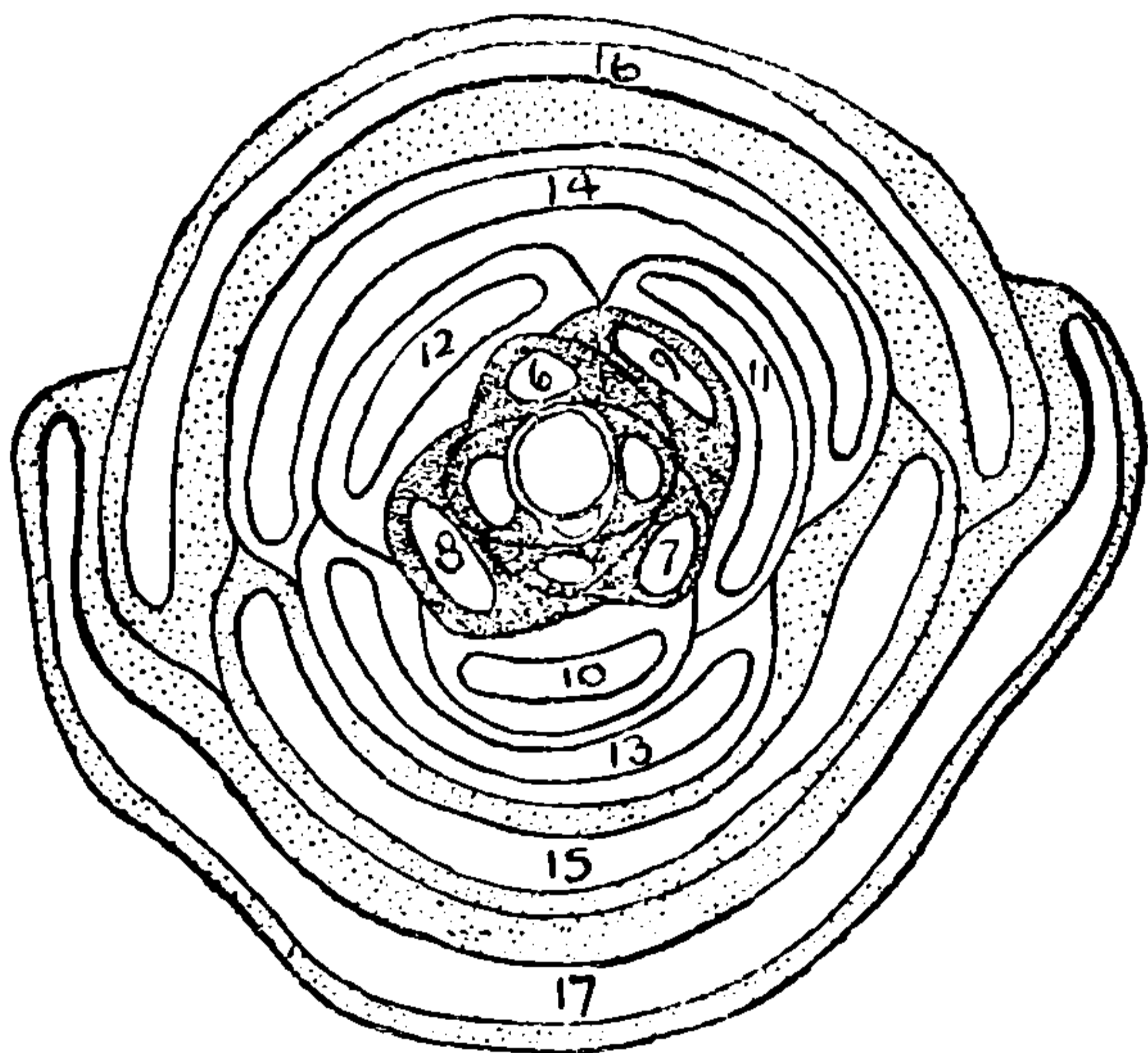

FIG. 27.—SECTION OF A MEGALOSPHERIC SPECIMEN OF *IDALINA ANTIQUA*.  $\times 25$  (AFTER MUNIER-CHALMAS AND SCHLUMBERGER). QUINQUELOCULINE STAGE IN HEAVY SHADING, TRILOCULINE STAGE UNSHADED, BILOCULINE STAGE IN LIGHT SHADING.

Another specimen with a larger megalospheric proloculum (fig. 28) shows the following development. A large proloculum is followed by a *Cornuspira*-like second chamber. Chambers 3 and 4 are arranged on a quinqueloculine plan  $144^\circ$  apart, in the other megalospheric specimen represented by 8 chambers, and in the microspheric specimen by 22. The triloculine stage is initiated by chamber 5 and the biloculine by the eighth.

Some of the very large megalospheric proloculi are followed in the section directly by the biloculine stage, skipping entirely the quinqueloculine and triloculine stages.

*Idalina* and the other uniloculine genera with similar developmental stages represent the height of development that it seems can be reached along this line. Certain genera—*Lacazina*, for example—may be more complex by the addition of labyrinthic partitions in the interior of the chambers, similar to the labyrinthic interior of *Fabularia*, which is otherwise like *Biloculina*.

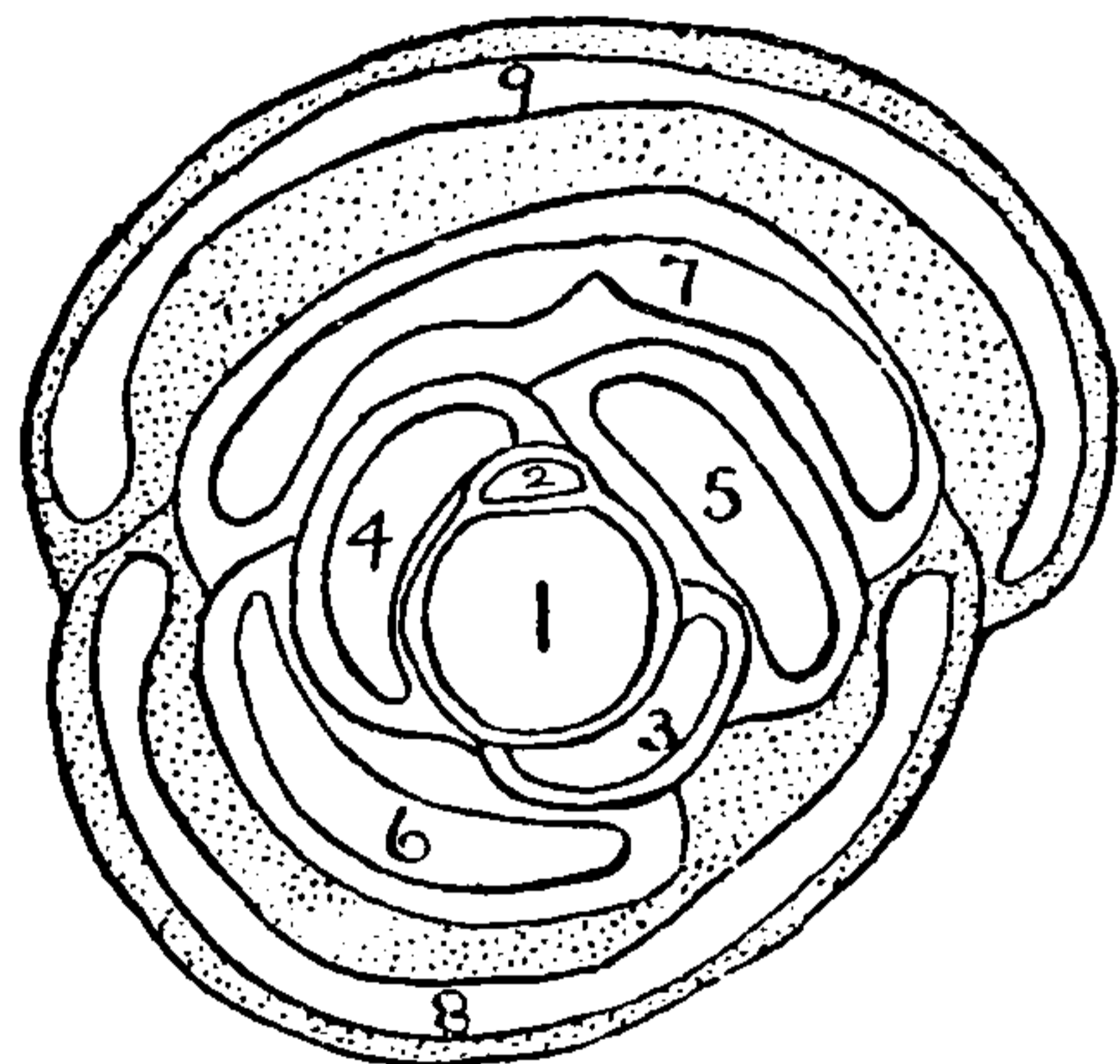

FIG. 28.—SECTION OF A SPECIMEN OF *IDALINA ANTIQUA* WITH A LARGE MEGALOSPHERIC PROLOCULUM (AFTER MUNIER-CHALMAS AND SCHLUMBERGER).

These uniloculine genera, then, bring to a climax the progressive development of the quinqueloculine group, and therefore the highest type of development in the family of the Miliolidae, with the exception possibly of the *Peneroplis* group, which in many ways are different from all other members of the family.

*Development of Peneroplis group.*—The development of typical specimens of *Orbitolites* and associated genera are considered under those genera in the systematic portion of the present paper and need not be further considered here except that they have the proloculum and *Cornuspira*-like second stage as in all other members of the family.

*General lines of development.*—From the preceding detailed descriptions of the development seen in certain genera it will be seen that the first two stages in all the members of the family, at least in the microscopic form, consist of a proloculum and second chamber apparently built by one continuous process and similar to the actual “embryonic” young which have been actually seen in the parent tests in several genera. Except for the length of the second chamber this stage has the characters of an adult *Cornuspira*, therefore that genus should be considered the basal member of the Miliolidae.

Following *Cornuspira* there are a series of genera which, like *Ophthalmidium*, gradually assume division of the tube into chambers of decreasing length, following a long *Cornuspira*-like stage, and the chambers all arranged in a planospiral manner. From here there are a

number of genera which take on uniserial or broadly flaring later developmental stages, but still keep to a single plane.

The more specialized group represented by *Quinqueloculina* as a basal member after the second *Cornuspira*-like stage develops chambers in constantly changing but definitely related planes. The earliest of these as seen in the ontogeny of various forms is quinqueloculine, chambers added in planes successively  $144^\circ$  apart and taking two horizontal whorls to complete a cycle. Following this in the ontogeny is a triloculine stage in higher genera with planes  $120^\circ$  apart, followed in some genera by a biloculine stage with planes  $180^\circ$  apart, and this followed in the highest genera by a uniloculine stage where chambers almost entirely include the previously developed chambers. These stages are especially complete in the microspheric forms of the species. The series of stages quinqueloculine, triloculine, biloculine, uniloculine is never, so far as has been seen, in any way reversed, and is only changed by the dropping out of stages in the accelerated megalospheric form. All of the four stages above mentioned are represented by generic types, the species of which show both microspheric and megalospheric forms.

Much of the apparent "variation" in this group may be directly traced to the differences in the microspheric and megalospheric forms and the various stages in development represented by the material at the time of collecting, especially if living tests are collected. By a full series of specimens and careful sectioning it should be possible to much more clearly define specific limits of true variation and a realization of the stages of development in the two forms of the species, a refinement which has not hitherto been attempted in any large series.

#### SYSTEMATIC TREATMENT.

#### Family 10. MILIOLIDAE.

Test typically calcareous, imperforate except in the very early stages of certain genera, porcellanous; sometimes the exterior with arenaceous covering, but always on an imperforate calcareous base, aperture typically with a tooth variously modified in different genera.

This family is one with a similar young throughout the group in the very early stages of at least the microspheric form of each species. The greatest number of species and individuals occur in the shallow waters of tropical seas, where, as in the West Indies, certain species such as *Orbiculina adunca* make up a large percentage of the foraminiferal content of shallow-water dredgings. The various species of *Orbitolites* are among the largest of the living foraminifera and are a conspicuous factor of the shallow water dredgings of certain parts of the Indo-Pacific region especially. The members of the family, however, are by no means limited to shallow tropical seas, as certain

genera, especially *Biloculina*, are conspicuous members of deep-water faunas, and in colder regions the prevalence of *Biloculina* in the "cold area" of the north Atlantic led Brady to designate the bottom as "*Biloculina* clay."

Subfamily 1. CORNUSPIRININAE.

Test usually free, the early stages composed of a proloculum and elongate, coiled second chamber, later chambers typically plano-spiral, of various lengths in typical chambers of the included genera.

Genus CORNUSPIRA Schultze, 1854.

*Orbis* PHILIPPI (part), Enum. Moll. Siciliae, vol. 2, 1844, p. 147.

*Operculina* CZJZEK (part), in Haidinger's Nat. Abhandl., vol. 2, 1848, p. 146.

*Cornuspira* SCHULTZE (type, *C. foliacea* PHILIPPI), Organismus Polythal., 1854, p. 40.—H. B. BRADY, Rep. Voy. Challenger, Zoology, vol. 9, 1884, p. 198.

*Spirillina* WILLIAMSON (part), Rec. Foram. Great Britain, 1858, p. 91.

*Description.*—Test consisting of a proloculum followed by a long coiled tubular chamber, typically without septae, complanate, the open end serving as the aperture, occasionally somewhat constricted or with a thickened lip; wall porcellanous.

This genus is the simplest of those of the whole family of the Miliolidae and is typical of the early development throughout the family at least in the microspheric form in highly accelerated species. It is very similar to the primitive genera, *Ammodiscus* in the Lituolidae and *Spirillina* in the Rotalidae.

Some authors have treated the three genera, *Ammodiscus*, *Cornuspira*, and *Spirillina* as really the same thing with a selective character determining the kind of wall. It seems much better, however, to take them as instances of parallelism in various families, much as are found elsewhere in other groups.

As a primitive genus *Cornuspira* should theoretically be found early in the paleontological development of the family, and such is the case, specimens referable to the genus having been recorded from the Lias. However, as the type of wall may be obscured, the mesozoic specimens are more or less dubious in character between *Spirillina* and *Cornuspira*. Throughout the Tertiary it is found very positively.

CORNUSPIRA FOLIACEA, (Philippi).

Plate 1, fig. 1; plate 2, fig. 1.

*Orbis foliaceus* PHILIPPI, Enum. Moll. Siciliae, vol. 2, 1844, p. 147, pl. 24, fig. 26.

*Cornuspira planorbis* SCHULTZE, Organismus Polythal., 1854, p. 40, pl. 2, fig. 21.

*Spirillina foliacea* WILLIAMSON, Rec. Foram. Great Britain, 1858, p. 91, pl. 7, figs. 199–201.

*Cornuspira foliacea* CARPENTER, PARKER, and JONES, Introd. Foram., 1862, p. 68, pl. 5, fig. 16.—REUSS, Denkschr. Akad. Wiss. Wien, vol. 25, 1865, p. 121, pl. 1, figs. 8, 9.—PARKER and JONES, Philos. Trans., vol. 155, 1865, p. 408, pl. 15, fig. 33.—BÜTSCHLI, in Bronn, Klassen und Ordnungen, Thier-Reichs, 1880, p. 189, pl. 4, fig. 8; pl. 8, fig. 1.—Goës, Kongl. Svensk. Vet. Akad. Handl., vol. 19, 1882, p. 120, pl. 9, figs. 308, 310.—H. B. BRADY, Rep.

Voy. *Challenger*, Zoology, vol. 9, 1884, p. 199, pl. 11, figs. 5-9.—BALKWILL and WRIGHT, Trans. Roy. Irish Acad., vol. 28 (Sci.), 1885, p. 326, pl. 12, figs. 1a-b.—EGGER, Abhandl. bay. Akad. Wiss. München, Cl. II, vol. 18, 1893, p. 247, pl. 3, figs. 20, 21.—FORNASINI, Mem. Accad. Sc. Istit. Bologna, ser. 5, vol. 3, 1893, p. 431, pl. 1, fig. 4.—GOËS, Kongl. Svensk. Vet. Akad. Handl., vol. 25, 1894, p. 106, pl. 18, fig. 834; Bull. Mus. Comp. Zoöl., vol. 29, 1896, p. 79.—MORTON, Proc. Portland Soc. Nat. Hist., vol. 2, 1897, p. 114, pl. 1, fig. 16.—MILLETT, Journ. Roy. Micr. Soc., 1898, p. 612.—BAGG, Proc. U. S. Nat. Mus., vol. 34, 1908, p. 123.

*Description*.—Test flattened, early portion of the tubular chamber of nearly uniform dimensions, but in later development rapidly increasing in height and forming a broad flat test; wall smooth except for occasional thickenings over the lines of growth; aperture a long slit the entire height of the tubular chamber.

Diameter of North Pacific specimens hardly more than 2 or 3 mm.

*Distribution*.—Goës records *Cornuspira foliacea* from two *Albatross* stations in the eastern tropical Pacific, one D3375 in 1,201 fathoms and the other only the depth is given, 700 fathoms.

There is apparently no mounted Pacific material in Goës's collection.

Bagg records it from off the Hawaiian Islands, not common at *Albatross* station D4017 in 309 fathoms. His single mounted specimen from this station which I have examined seems to be immature, but is undoubtedly this species. The only material I have had belonging definitely to this species is from *Albatross* station D4900 in 139 fathoms, off Japan, bottom temperature 52.9° F.

In the *Challenger* report Brady speaks of this species as more common in the Atlantic than elsewhere, and it certainly, from the material I have had, appears to be decidedly uncommon in the North Pacific.

Both microspheric and megalospheric forms occur.

#### CORNUSPIRA INVOLVENS (Reuss).

Plate 1, fig. 2; plate 2, fig. 2.

*Operculina involvens* REUSS, Denkschr. Akad. Wiss. Wien, vol. 1, 1849, p. 370, pl. 45, fig. 20.

*Cornuspira involvens* REUSS, Sitz. Akad. Wiss. Wien, vol. 48, 1863 (1864), p. 39, pl. 1, fig. 2.—JONES, PARKER, and H. B. BRADY, Pal. Soc., vol. 19, 1866, p. 3, pl. 3, figs. 52-54.—H. B. BRADY, Rep. Voy. *Challenger*, Zoology, vol. 9, 1884, p. 200, pl. 11, figs. 1-3.—BALKWILL and MILLETT, Journ. Micr., vol. 3, 1884, p. 23, pl. 1, fig. 1.—BALKWILL and WRIGHT, Trans. Roy. Irish Acad., vol. 28, 1885, p. 327, pl. 12, fig. 2.—H. B. BRADY, PARKER, and JONES, Trans. Zool. Soc., vol. 12, 1888, p. 216, pl. 40, figs. 1-3.—SHERBORN and CHAPMAN, Journ. Roy. Micr. Soc., 1889, p. 484, pl. 11, figs. 4, 5.—EGGER, Abhandl. bay. Akad. Wiss. München, Cl. II, vol. 18, 1893, p. 246, pl. 3, figs. 18, 19.—T. RUPERT JONES, Pal. Soc., 1895, p. 128, pl. 3, figs. 52-54.—MORTON, Proc. Portland Soc. Nat. Hist., vol. 2, 1897, p. 114.—MILLETT, Journ. Roy. Micr. Soc., 1898, p. 612.—CHAPMAN, Journ. Linn. Soc. Zoology, vol. 30, 1907, p. 22, pl. 2, fig. 46.—BAGG, Proc. U. S. Nat. Mus., vol. 34, 1908, p. 123.

*Description*.—Test biconvex, the edges becoming somewhat thicker as growth progresses, tubular portion of nearly equal height throughout, slightly embracing; wall smooth except for occasional slight varices of growth; aperture nearly the size of the open end of the tube.

Diameter 1 mm. or slightly more.

*Distribution*.—Brady notes the occurrence of this species in the North Pacific, but gives no definite stations. Bagg records it from two stations off the Hawaiian Islands, *Albatross* D4017 and D4174 in 305 and 735–865 fathoms, respectively. His material which I have examined is typical.

In the material I have had there are specimens from *Albatross* station 3608 in 276 fathoms off the Galapagos, *Nero* 2071 in 271 fathoms off the Hawaiian Islands, D4900 in 139 fathoms, and D4875 in 59 fathoms off Japan. The specimens from D4900 were larger and finer than those from the other stations.

In the *Tuscarora* material this species has occurred at the following stations: 5, in 1,200 fathoms, latitude 37° 04' N.; longitude 123° 22' W.; 11, in 437 fathoms, latitude 33° 46' N.; longitude 140° 21' E.; and 42, in 108 fathoms, latitude 27° 16' N.; longitude 141° 56' E.

Both microspheric and megalospheric forms of the species occur, the microspheric specimens being considerably larger than the megalospheric.

CORNUSPIRA LACUNOSA H. B. Brady.

Plate 2, fig. 3.

*Cornuspira lacunosa* H. B. BRADY, Rep. Voy. *Challenger*, Zoology, vol. 9, 1884, p. 202, pl. 113, fig. 21.

*Description*.—"Test discoidal, biconcave, peripheral edge rounded; convolutions numerous, narrow near the center; aperture dome-shaped; surface decorated, especially on the outer whorls, with a series of irregular, anastomosing costae, the main lines of which are more or less parallel to the axis of growth. Diameter one fiftieth inch (0.5 mm.) or rather more."

*Distribution*.—Brady described this species from *Challenger* station 185, off Raine Island, Torres Strait, in 155 fathoms. It seems to be a rare species to judge from the absence of data. From *Albatross* station D4900 in 139 fathoms off Japan where many species allied or identical with those of the Torres Strait region occur there were obtained several specimens referable to this species. They are very different, however, in certain characters. The early portion is undoubtedly identical with the species figured by Brady but in the larger specimens which show the later development there is a modification of the ornamentation. In the last-formed coil there is a loss of the lacunose ornamentation and the wall is nearly smooth except for very definite but fine longitudinal striae. The last-formed whorl



is usually distinctly broader than that portion showing the lacunose ornamentation. As Brady had the species from but the one station and the number of specimens is not hinted at it seems reasonable to suppose without further data that the *Challenger* specimens were immature and did not show the full specific characters which the *Albatross* specimens show.

The *Albatross* specimens are also much larger than the measurements given by Brady but the lacunose portion usually does not exceed 1 mm., another fact which seems to substantiate the idea that the *Challenger* material was immature.

In specimens which have a broadened last coil there is a tendency to lose the ornamentation progressively as in certain species of *Cristellaria*. The prominent striae are retained on the inner border of the chamber, while the peripheral portion is nearly if not quite smooth.

Altogether these form a decidedly interesting suite of specimens.

In connection with the present material it is worthy of note that Chapman has figured a specimen from the Tertiary of Victoria as *Cornuspira striolata* Brady,<sup>1</sup> which has very close affinities with the Japanese material. One or two of our specimens have just such a terminal portion as that figured by Chapman and the early chambers while indistinct in that figure seem to be rather coarsely striate or even lacunose. As the original specimens of *C. striolata* from the Faroe Channel had a very highly developed peripherally expanded test and those of Goës also from the subarctic waters had a similar form it seems as if we had here in the Indo-Pacific region a definite species, the range of which may probably be found to be from Australia northward to Japan and existing as a fossil in the Tertiary at least of Australia.

The large recent specimens which show the expanded last coil are microspheric, and it may be that the megalospheric form does not have the later stages. Brady's figure of *C. lacunosa* seems, compared with our specimens, to be megalospheric and stops at this point in its development.

#### Genus OPTHALMIDIUM Zwingli and Kübler, 1870.

*Oculina* KÜBLER and ZWINGLI (type, *O. porosum* Zwingli and Kübler), Neujahrsblatt Burgersbibl., Winterthur, 1866, p. 11.

*Ophthalmidium* ZWINGLI and KÜBLER, Foram. Schweiz Jura, 1870, p. 46.—

H. B. BRADY, Rep. Voy. *Challenger*, Zoology, vol. 9, 1884, p. 188.

*Hauerina* H. B. BRADY (part), Quart. Journ. Micr. Sci., vol. 19, 1879, p. 54.

*Description*.—Test in general planospiral, compressed, all chambers visible from the exterior on both sides, proloculum globular, followed by a coiled second chamber making usually two or more coils,

<sup>1</sup> Journ. Linn. Soc. Zoology, vol. 30, 1907, p. 23, pl. 3, fig. 47.

the following chambers gradually decreasing in relative length, more or less loose coiled, the intermediate area filled in with a shelly plate; aperture at the end of the chamber, rounded, without lip or teeth.

The genus *Ophthalmidium* is very evidently an advance from *Cornuspira* toward a condition seen in the genus *Spiroloculina*. The relative length of the second chamber shows a decidedly primitive character and the succeeding relative shortening of the chambers is also decidedly primitive, characters which in the development of *Spiroloculina* are greatly reduced by acceleration of development.

*Ophthalmidium* is rather rare in recent oceans, but in the Lias especially seems to have been much more abundant and characterized by more species than at present.

OPHTHALMIDIUM INCONSTANS H. B. Brady.

Plate 3, figs. 1-4.

*Hauerina inconstans* H. B. BRADY, Quart. Journ. Micr. Sci., vol. 19, 1879, p. 54.  
*Ophthalmidium inconstans* H. B. BRADY, Rep. Voy. Challenger, Zoology, vol. 9, 1884, p. 189, pl. 12, figs. 5, 7, 8.—H. B. BRADY, PARKER, and JONES, Trans. Zool. Soc., vol. 12, 1888, p. 216, pl. 40, figs. 12, 13.—EGGER, Abhandl. bay. Akad. Wiss. München, Cl. II, vol. 18, 1893, p. 244, pl. 3, figs. 6, 49.—MILLETT, Journ. Roy. Micr. Soc., 1898, p. 608.—CHAPMAN, Journ. Linn. Soc. Zoology, vol. 30, 1910, p. 398.

*Description*.—Test planospiral, much compressed, chambers consisting of a globular proloculum, followed by a *Cornuspira*-like coiled second chamber, making two or more volutions, this in turn followed by chambers progressively relatively shorter in length until the adult condition is reached, where chambers are half a volution in length or less, chambers nearly circular in transverse section with a thin wide flange on the peripheral border, chambers often slightly less coiled toward the apertural end, leaving a space filled by a thin plate of shelly material; aperture circular without lip or teeth.

Diameter, about 1.5 mm. in the largest specimens.

*Distribution*.—Brady records in his generalized statement that he had this species from the North Pacific, but gives no definite stations.

The only material I have had is from *Nero* station, 1466, in 234 fathoms off Guam.

OPHTHALMIDIUM TUMIDULUM H. B. Brady.

Plate 3, fig. 5.

*Ophthalmidium tumidulum* H. B. BRADY, Rep. Voy. Challenger, Zoology, vol. 9, 1884, p. 189, pl. 12, fig. 6.

*Description*.—“Test complanate, commencing growth as a rounded tube coiled upon a somewhat inflated primordial chamber in a planospiral manner; the earlier convolutions nonseptate and cornuspira-like, the subsequent ones constricted at intervals and eventually more or less regularly *Spiroloculine*; peripheral edge rounded. Aper-

ture arched or rounded, formed of the slightly constricted end of the tube.

“Longer diameter, one-thirtieth inch (0.8 mm.).”

*Distribution*.—Brady gives a single North Pacific record for this species, *Challenger* station 241 in 2,300 fathoms. I have found no specimens in the material I have examined. The figures and description are from Brady.

#### Genus SPIROLOCULINA d'Orbigny, 1826.

*Spiroloculina* D'ORBIGNY, Ann. Sci. Nat., vol. 7, 1826, p. 298 (Type *S. depressa*, d'Orbigny).—H. B. BRADY, Rep. Voy. *Challenger*, Zoology, vol. 9, 1884, p. 147.

*Description*.—Test composed of chambers arranged planospirally, all visible typically from opposite sides of the test, early chambers after the proloculum sometimes a coil or more in length, but the adult chambers one-half coil in length; aperture typically somewhat produced; aperture circular, with a prominent lip and a bifid tooth occasionally, with a secondary tooth directly opposite the primary one.

Certain of the species which were described as *Spiroloculina* have typical quinqueloculine development until the final chambers, and for these the genus *Massilina* was created by Schlumberger.

#### SPIROLOCULINA DEPRESSA d'Orbigny.

Plate 3, figs. 6–10.

*Spiroloculina depressa* D'ORBIGNY, Ann. Sci. Nat., vol. 7, 1826, p. 298.—WILLIAMSON, Rec. Foram. Great Britain, 1858, p. 82, pl. 7, fig. 177.—TERQUEM, Mem. Soc. Geol. France, ser. 3, vol. 1, 1878, p. 54, pl. 5, fig. 11.—WIESNER, Archiv. Prot., vol. 25, 1912, p. 210.

*Spiroloculina limbata* H. B. BRADY (not d'Orbigny), Rep. Voy. *Challenger*, Zoology, vol. 9, 1884, p. 150, pl. 9, figs. 15–17.

*Description*.—Test in side view elliptical or rounded, in end view with the sides nearly parallel, the periphery flattened or even slightly convex, chambers numerous, in front view with the periphery and the inner margin of the chamber raised, the intermediate space more or less depressed, giving the appearance of having limbate sutures; apertural end of the chamber usually with a short neck hardly extending beyond the margin of the test, lip little if at all developed; aperture nearly circular; tooth single with a bifid tip; wall smooth, dull.

Length, 1–1.5 mm.

*Distribution*.—Brady in the *Challenger* report includes the North Pacific indirectly in his statement of distribution for this species, but gives no definite localities.

In the material that I have examined the species has occurred a number of times, as follows: *Tuscarora* 2, in 108 fathoms, latitude 27° 16' N.; longitude 141° 56' E.; *Nero* 2033 in 249 fathoms, 2034 in 175 fathoms, 2036 in 82 fathoms, and 2041 in 33 fathoms, all off

the Hawaiian Islands; *Albatross* H4881 in 316 fathoms in Colnett Strait, D4807 in 44 fathoms off Hakodate, Japan, D4874 in 66 fathoms eastern channel, Korea Strait, D4900 in 139 fathoms Eastern Sea of Japan, and D5068 in 77 fathoms Suruga Gulf, Japan; Gaspar Straits, North Pacific Exploring Expedition, Captain Rodgers. An extreme form from *Nero* 1466, in 234 fathoms off Guam, is shown in figure 7.

SPIROLOCULINA CANALICULATA d'Orbigny.

Plate 4, figs. 1-3.

*Spiroloculina canaliculata* D'ORBIGNY, Foram. Foss. Bass. Tert. Vienne, 1846, p. 269, pl. 16, figs. 10-12.

*Spiroloculina impressa* H. B. BRADY (not Terquem), Rep. Voy. *Challenger*, Zoology, vol. 9, 1884, p. 151, pl. 10, figs. 3, 4.

*Description.*—Test elliptical in front view, the ends of the final chamber projecting somewhat at both ends, in end view, the sides nearly parallel, the angles of the periphery of the chamber produced into thin plates, the space between being typically concave, chambers rather neatly joined to one another, the joining being flush so that little difference in the surface is noted from the exterior to the center; apertural end produced into a cylindrical neck, with a flaring, phialine lip, the aperture itself being circular with a bifid tooth on the inner margin, the projections forming a concave plate, often an accessory simple tooth on the opposite border of the aperture, wall smooth and shining, white.

Length, 1-1.5 mm.

*Distribution.*—The only North Pacific record for this species that is published is that given by Brady, a *Challenger* station in the Philippine region, in 95 fathoms.

In the *Tuscarora* material the species has occurred at three stations near the Bonin Islands, 1, in 73 fathoms, latitude 27° 07' N.; longitude 142° 07' E.; 2, in 108 fathoms, latitude 27° 16' N.; longitude 141° 56' E.; and 3, in 345 fathoms, latitude 27° 47' N.; longitude 141° 50' E. There are four stations for the species in the *Albatross* material off Japan, D4874 in 66 fathoms and D4875 in 59 fathoms, both in the eastern channel of Korea Strait; D4900 in 139 fathoms, Eastern Sea of Japan, and D4949, 110 fathoms.

From the *Nero* material in the vicinity of the Hawaiian Islands it has occurred at stations 2040 in 21 fathoms and 2071 in 271 fathoms.

This species may be most easily distinguished by the deeply concave periphery of the chambers between the two prominent plate-like margins of the chamber. The true *S. impressa* of Terquem has a flat periphery instead of a concave one.

## SPIROLOCULINA GRATELOUPI d'Orbigny.

Plate 4, figs. 4, 5.

*Spiroloculina grateloupi* D'ORBIGNY, Ann. Sci. Nat., vol. 7, 1826, p. 298.—  
TERQUEM, Mém. Soc. Geol. France, ser. 3, vol. 1, 1878, p. 52, pl. 5, figs.  
5, 6.—WEISNER, Archiv. Prot., vol. 25, 1912, p. 208.

*Spiroloculina excavata* H. B. BRADY (not d'Orbigny), Rep. Voy. *Challenger*,  
Zoology, vol. 9, 1884, p. 151, pl. 9, figs. 5, 6.

*Description*.—Test elongate, broadest in the center, tapering toward either end, chambers rapidly thickening as added, in end view the periphery much the broadest portion of the test, central portion deeply excavated; periphery of the chambers in end view much convex, especially in the central portion, the edges broadly rounded; chambers evenly curved, the final chamber somewhat projecting both at the base and at the apertural ends, the latter having a decided neck with a phialine lip, the aperture itself rounded and with either a single tooth with a bifid end, the two projections forming a concave extremity or in some cases a pair of such bifid teeth opposite one another; surface of the test dull, somewhat roughened.

Length, 1–1.5 mm.

*Distribution*.—From the existing records this seems to be a species of a rather tropical distribution. The only published record for the North Pacific is that given by Brady, *Challenger* station 260A, in 40 fathoms, on the Honolulu coral reefs.

I have had material from the same region and from *Nero* station 2042 in 55 fathoms, Waimea Bay, Hawaiian Islands. It has also occurred in material from Hongkong and from Singapore. In the material of the North Pacific Exploring Expedition, Captain Rodgers, it occurs in Gaspar Straits. From the *Albatross* material it occurs from H4882, in 248 fathoms, in Colnett Strait.

## SPIROLOCULINA ACUTIMARGO H. B. Brady.

Plate 5, fig. 1.

*Spiroloculina acutimargo* H. B. BRADY, Rep. Voy. *Challenger*, vol. 9, 1884, p.  
154, pl. 10, figs. 12–15.—BAGG, Proc. U. S. Nat. Mus., vol. 34, 1908, p. 119.

*Description*.—“Test oval, complanate, thin, slightly convex on both sides; peripheral margin acute or carinate, extremities obtuse or slightly rounded; chambers arcuate, angular, or carinate at the outer margin, either slightly embracing or separated by the intervening wing of the previous convolutions; aperture small, sometimes in a produced tubular extension of the final segment.

“Length, one-thirtieth inch (0.85 mm.)”

*Distribution*.—The only recorded stations for this species in the North Pacific are those given by Bagg off the Hawaiian Islands, *Albatross* D4174, 735–865 fathoms, D4025, 275–368 fathoms, and H4694, in 865 fathoms.

In the material which I have had the species has been observed but once, *Nero* station 990, in 859 fathoms off Guam. This specimen is here figured. It is rather more extreme in its flattened character than in the figures given by Brady, reminding one somewhat of *Ophthalmidium inconstans*. The specimen agrees with both the figure and description given by Brady in that the platelike carina separates the chambers from one another very distinctly. In this character the present species differs from that described here as *S. tenuimargo* which, although having a carina well developed on the last-formed chambers, does not have the chambers well separated in the body of the test.

**SPIROLOCULINA TENUIMARGO, new species.**

Plate 5, figs. 2, 3.

*Description.*—Test much compressed, planospiral, chambers numerous, usually more swollen toward the basal end, inflated, nearly circular in transverse section, the apertural end somewhat produced, surface smooth; periphery of the test with a distinct, rather broad, sharp, platelike carina, in young specimens rather even, but in older ones more or less irregular; chambers closely adjacent to one another, not separated; apertural end with a slightly produced and slightly flaring lip; aperture round.

Length, slightly less than 1 mm.

*Distribution.*—Specimens were obtained from two stations; the type, Cat. No. 9153, U. S. N. M., from *Nero* 1466, in 234 fathoms off Guam and another lot from *Albatross* D4967, in 244 fathoms off the coast of Japan.

This species while having a marginal carina as in *S. acutimargo* H. B. Brady, has the chambers closely adjacent to one another and not separated by a flat platelike portion as in that species, the form of the chambers is also very different from those of our species, being differently curved and having the basal portion much swollen, especially in the earlier chambers.

**SPIROLOCULINA TENUISSIMA Reuss.**

*Spiroloculina tenuissima* REUSS, Sitz. Akad. Wiss. Wien, vol. 55, 1867, p. 71, pl. 1, fig. 11.

*Spiroloculina tenuis* H. B. BRADY (not Czjzek) (part), Rep. Voy. *Challenger*, Zoology, vol. 9, 1884, p. 152, pl. 10, figs. 9, 10 (not 7, 8, 11).

*Description.*—Test very thin, translucent, elongate, compressed, in front view tapering toward either end, chambers long and narrow, peripheral margin broadly rounded, chambers in transverse section, circular; apertural end produced into an elongate neck, aperture rounded usually without distinct teeth, wall smooth.

Length, usually less than 0.5 mm.

*Distribution.*—Bagg records this species as *S. tenuis* from six *Albatross* stations in the vicinity of the Hawaiian Islands, varying in depth from 104 to 1,259 fathoms.

The species occurred at the following stations in the *Nero* and *Albatross* material: *Nero* 1464 in 891 fathoms off Guam; 1054 in 1,863 fathoms, 1065 in 1,321 fathoms, 1075 in 1,029 fathoms, and 1122 in 1,926 fathoms, all between Guam and Japan: *Albatross* D4979 in 943 fathoms off the coast of Japan.

The species described by Czjzek has a Milioline early development and is not a true *Spiroloculina*. Most of the stations for this species are in comparatively deep water.

SPIROLOCULINA ROBUSTA H. B. Brady.

*Spiroloculina robusta* H. B. BRADY, Rep. Voy. *Challenger*, Zoology, vol. 9, 1884, p. 150, pl. 9, figs. 7, 8.—FLINT, Ann. Rep. U. S. Nat. Mus., 1897 (1899), p. 296, pl. 42, figs. 1, 2.

*Description.*—"Test oblong or oval, with angular or pointed extremities, compressed or complanate; broad and thick, slightly concave on both faces, rounded at the periphery. Segments few in number, much arched; the inner margin of each overlapping a considerable portion of the previous segment on the same side, their lateral surfaces crested by angular ridges.

"Length, one-tenth inch (2.5 mm.)."

This species was described by Brady from the region of the West Indies, but there are two lots of material in that from the North Pacific which seem to belong to it. These are both from the same general region, *Tuscarora* 58, in 814 fathoms, latitude 26° 52' N., longitude 142° 21' E.; and *Nero* 1308 in 1,040 fathoms.

SPIROLOCULINA MILLETTI Wiesner.

Plate 5, fig. 4.

*Spiroloculina nitida* H. B. BRADY (not *S. nitida* d'Orbigny, 1826) Rep. Voy. *Challenger*, Zoology, vol. 9, 1884, p. 149, pl. 9, figs. 9, 10.—MILLETT Journ. Roy. Micr. Soc., 1898, p. 265, pl. 5, figs. 9-12.—FLINT, Ann. Rep. U. S. Nat. Mus., 1897 (1899), p. 296, pl. 41, fig. 4.—BAGG, Proc. U. S. Nat. Mus., vol. 34, 1908, p. 119.

*Spiroloculina milletti* WIESNER, Archiv. Prot., vol. 25, 1912, p. 207.

*Description.*—Test more or less compressed, the chambers closely adjacent or even a little overlapping, numerous, of about even diameter throughout, usually somewhat angular in transverse section, in adult specimens the last-formed chamber with an acute periphery, that of the preceding chamber square or even somewhat concave, apertural end of the chamber somewhat produced, with a distinct tubular neck and occasionally a slightly phialine lip, the aperture rounded, with a single bifid tooth the projections of which are at right angles to the main plate; surface smooth and shining, white.

Length, about 1 mm.

*Distribution.*—The following are the existing records for this species in the North Pacific: Honolulu coral reefs, *Challenger* station 260A, in 40 fathoms (Brady); "collected in the Gulf of Tokio" (Flint); off the Hawaiian Islands, *Albatross* D4017, in 305 fathoms, (Bagg).

The only material which I have had referable to this species is from off the Hawaiian Islands, *Nero* station 2070 in 285 fathoms.

This species, which, as described by Wiesner, is evidently different from the *S. nitida* of d'Orbigny, seems to be a tropical one. From the notes of Millett there seems to have been two distinct things in the Malay material, the figured "wild-growing" forms being distinctly stated by Millett to have cylindrical chambers.

**SPIROLOCULINA NUDA, new species.**

Plate 5, fig. 5.

*Description.*—Test in front view elongate, tapering toward the ends, in end view with the periphery of the chambers much convex, edges rounded, chambers with the inner margin slightly raised, in some specimens usually smooth, the sutures very indistinct, the wall often devoid of all sculpture or trace of sutures, apertural end somewhat extended, forming a slender cylindrical neck ending in a broad flaring lip, area at the base of the neck often concave, the sides of the chamber at this point being slightly carinate, giving a channeled appearance to the region; aperture small, circular, with a single bifid tooth; wall white, dull.

Length of largest adult specimen, 2 mm.

*Distribution.*—Type-specimen (Cat. No. 9154, U.S.N.M.) from *Nero* station 2070 in 285 fathoms off the Hawaiian Islands; other specimens from *Nero* 2037 in 55 fathoms, Waimea Bay, Hawaiian Islands and *Albatross* H3007 in 323 fathoms in the same general region.

This is a peculiar species and a rather delicately lined one, the rather long tapering neck with the channeling at the base being unusual even in this genus. The dull white exterior, chalky in appearance, with its lack of defined lines either of chambers or of ornamentation, also is noteworthy. Outside the region of the Hawaiian Islands it was not met with in the North Pacific material.

**SPIROLOCULINA COSTIFERA, new species.**

Plate 6, figs. 1-3.

*Description.*—Test large, planospiral, chambers few in number, the early ones close coiled, later ones with the tip of the apertural end standing away from the previous chamber, the next chamber added often not filling the gap thus made and in the adult not reaching to the base of the preceding chamber, sutures indistinct; surface of the test with a few longitudinal coarse costae, running the whole length



of the chamber; apertural end of the chamber produced to form an elongated neck which has a well-developed phialine lip and a single tooth on the inner margin of the aperture which is flattened on the inner side; wall except for the costae smooth, white, dull.

Diameter, up to 3.5 mm.

*Distribution*.—Type-specimen (Cat. No. 9155, U.S.N.M.) from *Nero* station 190 in 864 fathoms off Midway Island. The other material was from *Albatross* station H2999 in 549 fathoms off the Hawaiian Islands.

This is a very large and striking species both in its general appearance and in the feature of its partially uncoiling at the end of the chamber in the adult test. This latter feature reminds one of the similar character seen in some of the Quinqueloculine group, but our species is a true *Spiroloculina* as the transverse section here figured shows.

**SPIROLOCULINA UNICOSTATA, new species.**

Plate 7, figs. 1, 2.

*Description*.—Test small, one side slightly convex, the opposite side concave, chambers numerous; convex side of test marked by a continuous costa or series of costae, one at the inner border of each chamber, both ends of the last formed chamber produced, the basal portion forming a bluntly rounded projection, the apertural end with a produced cylindrical neck with broadly phialine lip, the aperture circular and, as far as the specimens at hand show, there is no tooth.

Length, 0.30 mm.

*Distribution*.—Type-specimen (Cat. No. 9156, U.S.N.M.) from *Nero* station 1464 in 891 fathoms off Guam.

This in some ways seems related to such concave species as *S. affixa* Terquem and *S. inaequilateralis* Schlumberger.

**SPIROLOCULINA GRATA Terquem.**

Plate 7, figs. 3, 4.

*Spiroloculina grata* TERQUEM, Mém. Soc. Géol. France, sér. 3, vol. 1, 1878, p. 55, pl. 5, figs. 14a–15b.—H. B. BRADY, Rep. Voy. *Challenger*, Zoology, vol. 9, 1884, p. 155, pl. 10, figs. 16, 17.

*Description*.—Test in front view rhomboid oval, the extremities somewhat produced, giving an angular appearance to the test, in end view with the sides parallel, the periphery well rounded; chambers long and slender, cylindrical, circular in transverse section, the surface marked by oblique longitudinal costae; apertural end of the chamber produced to form a tapering neck, circular in transverse section; the aperture circular with a single tooth on the inner margin; surface of the test usually finely papillate as seen with higher magnifications; wall often brownish, translucent.

Length, usually less than 1 mm.

*Distribution.*—Brady records this species from a single North Pacific locality, *Challenger* station 260A in 40 fathoms off the coral reefs of Honolulu, Hawaiian Islands. Bagg records it also from the same region at a single *Albatross* station D4017 in 305 fathoms.

In the *Nero* material it has occurred at a number of stations in the vicinity of the Hawaiian Islands, especially about Waimea Bay. It also occurred in the *Nero* dredgings from Guam. Off the southern coast of Japan it has occurred a few times in the shallower warmer waters in the southern part, especially *Albatross* H4881 in 316 fathoms in Colnett Strait. From the North Pacific Exploring Expedition, Captain Rodgers, there are specimens from Gaspar Straits.

The following variety seems worthy of notice:

**SPIROLOCULINA GRATA Terquem, var. ANGULATA, new variety.**

Plate 7, fig. 5.

*Spiroloculina grata* H. B. BRADY (part), Rep. Voy. *Challenger*, Zoology, vol. 9, 1884, pl. 10, figs. 22, 23.

*Spiroloculina nitida* (Striate variety) MILLETT, Journ. Roy. Micr. Soc., 1898, p. 266.

*Description.*—Variety differing from the typical in having the chambers angular instead of circular in transverse section and the costae parallel to the peripheral margin of the chamber instead of oblique as in the typical, in extreme forms with the periphery having a decided keel.

*Distribution.*—Type-specimen (Cat. No. 9157, U.S.N.M.) from Cebu, Philippines, collected by Dr. E. A. Mearns. Specimens also occurred in shallow water about the Hawaiian Islands in Waimea Bay and off Honolulu.

The figures given by Brady and referred to here, especially figure 23, is very much like that figured here. Millett notes that most of the Malay Archipelago material was of this form.

Both the typical form and the variety seem to be characteristic of shallow water in the Tropics, especially off coral reefs.

**SPIROLOCULINA ARENARIA H. B. Brady.**

*Spiroloculina arenaria* H. B. BRADY, Rep. Voy. *Challenger*, Zoology, vol. 9, 1884, p. 153, pl. 8, fig. 12.

*Description.*—“Test oblong or oval, complanate; extremities obtusely angular or slightly rounded, peripheral edge rounded; segments few and broad, indistinct externally. Aperture small, circular, with milioline tongue; situated in a slightly produced shelly neck. Exterior sandy; length, one-fifteenth inch (1.7 mm.)”

*Distribution.*—From Brady's account of this species it is one of those limited to the East Indian region, occurring from Torres Strait northward to the Philippines. In the North Pacific the only record is from the *Challenger* station in the Philippines in 95 fathoms.

## Genus PLANISPIRINA Seguenza, 1880.

*Planispirina* SEGUENZA, Atti R. Accad. Lincei, ser. 3, vol. 6, 1880, p. 310 (Type *P. communis* Seguenza).—H. B. BRADY, Rep. Voy. *Challenger*, Zoology, vol. 9, 1884, p. 193 (part).

*Description*.—Test planospiral, chambers in the later growth often more or less involute, concealing the early development, which consists of an oval proloculum, followed by the typical *Cornuspira*-like second chamber, in turn followed by several chambers gradually becoming shorter, those of the adult being less than a half coil in length, usually three or four necessary to make a complete coil.

## PLANISPIRINA SPHAERA (d'Orbigny).

Plate 19, fig. 1.

*Biloculina sphaera* D'ORBIGNY, Voy. Amer. Merid., 1839, "Foraminiferes," p. 66, pl. 8, figs. 13-16.—H. B. BRADY, Trans. Linn. Soc. London, vol. 24, 1864, p. 466, pl. 48, figs. 1a-b.; Rep. Voy. *Challenger*, Zoology, vol. 9, 1884, p. 141, pl. 2, figs. 4a, b.—SCHLUMBERGER, Feuille des Jeunes Naturalistes, vol. 13, pl. 2, fig. 3.—GÖES, Bull. Mus. Comp. Zoöl., vol. 29, 1896, p. 84.

*Planispirina sphaera* SCHLUMBERGER, Mém. Soc. Zoöl. France, 1891, p. 190, text figs. 45, 46.

*Description*.—Test globular, smooth, two chambers only visible in the adult, the last formed chamber making up nearly all the visible portion of the test, the penultimate chamber represented in the adult by a small protuberant circular area not covered by the last formed chamber; chambers arranged planospirally, three chambers necessary to complete a coil; aperture in the younger specimens V-shaped, in older ones becoming a complex series of irregular narrow openings not raised or but slightly above the general surface of the test.

Diameter, up to 4 mm.

*Distribution*.—Göes records this species from the *Albatross* material off the western coast of America at depths of 700 and 1,300 fathoms, stations not given. Material in the Göes collection from *Albatross* D3400 in 1,322 fathoms labeled this species by Göes proves upon examination to be rather *Biloculina globulus* Bornemann. In the same collection, however, there is a series of Atlantic specimens which are *P. sphaera* (d'Orbigny). I have had material from *Nero* station 2070 in 258 fathoms off the Hawaiian Islands and *Albatross* D5056 in 258 fathoms, Suruga Gulf, Japan. These latter were very large.

## Genus VERTEBRALINA d'Orbigny, 1826.

*Vertebralina* D'ORBIGNY (Type *Vertebralina striata* d'Orbigny), Ann. Sci. Nat., vol. 7, 1826, p. 283.—H. B. BRADY, Rep. Voy. *Challenger*, Zoology, vol. 9, 1884, p. 186.

*Description*.—Test with the early chambers planospiral, at least from external appearances, later ones becoming rectilinear; wall

porcellanous, imperforate, usually ornamented by striations or costae; aperture a long narrow slit either at the outer end of the chamber or somewhat laterally placed; typically with a definite lip.

According to the distinctions made by d'Orbigny this genus included species which had the early chambers arranged in a planospiral manner, later becoming uniserial and uncoiled. This distinction has not been strictly adhered to and it has become not unusual to find either this genus or *Articulina* used for both. Certain of the forms assigned to *Vertebralina* do have an external resemblance to a planospiral condition in the young, but like *Hauerina* are really milioline.

The number of species is very small, mostly known from recent material.

VERTEBRALINA STRIATA d'Orbigny.

Plate 22, figs. 3, 4.

*Vertebralina striata* D'ORBIGNY, Ann. Mag. Nat. Hist., vol. 7, 1826, p. 283, No. 1; Modèles, No. 81.—WILLIAMSON, Recent Foram. Great Britain, 1858, p. 90, pl. 7, figs. 196a, b [197, 198].—CARPENTER, PARKER, and JONES, Introd. Foram., 1862, p. 72, pl. 5, figs. 17-25.—PARKER, JONES, and H. B. BRADY, Ann. Mag. Nat. Hist., ser. 3, vol. 16, 1865, p. 32, pl. 1, fig. 1.—BRADY, Rep. Voy. Challenger, Zoology, vol. 9, 1884, p. 187, pl. 12, figs. 14-16.—EGGER, Abhandl. bay. Akad. Wiss. München, Cl. II, vol. 18, 1893, p. 243, pl. 3, figs. 33, 34.—MILLETT, Journ. Roy. Micr. Soc., 1898, p. 607, pl. 13, fig. 1.—SIDEBOTTOM, Mem. and Proc. Manchester Lit. and Philos. Soc., vol. 48, 1904, pt. 2, No. 5, p. 18; vol. 54, pt. 3, 1910, No. 16, p. 6.—CHAPMAN, Journ. Quekett Micr. Soc., ser. 2, vol. 10, 1907, p. 125.

*Description.*—Test compressed, slightly trochoid, early portion close coiled, increasing rapidly in diameter, last formed chambers in adult becoming uniserial, broadly expanded, the sutures strongly curved, slightly depressed, surface ornamented by fine longitudinal striae; aperture elongate, irregular, the lip on one side being shorter than on the other, making the aperture really on the ventral side of the test, lip smooth, ends rounded and not projecting.

Length, up to 1.2 mm., usually less.

*Distribution.*—Brady records this species in one of his tables from off Honolulu, Hawaiian Islands, in 40 fathoms. I have had material from several *Nero* stations near the Hawaiian Islands, 2034 in 175 fathoms; 2037 in 55 fathoms; 2039 in 24 fathoms; 2071 in 271 fathoms; and 2074 in 22 fathoms. Most of Bagg's material from this region was from deeper water, which probably accounts for its nonoccurrence in his report.

The trochoid arrangement of the chambers in the typical species, *V. striata*, and its aperture on the ventral side of the test make it very different from *V. insignis*, which is in these two points very unlike the generic characters, and it may be questioned whether they really belong together.

## VERTEBRALINA INSIGNIS H. B. Brady.

Plate 22, figs. 1, 2.

*Vertebralina insignis* H. B. BRADY, Rep. Voy. *Challenger*, Zoology, vol. 9, 1884, p. 187, pl. 12, figs. 9-11.—FLINT, Rept. U. S. Nat. Mus., 1897 (1899), p. 302, pl. 47, fig. 4.—BAGG, Proc. U. S. Nat. Mus., vol. 34, 1908, p. 123.

*Description*.—"Test compressed, planospiral, subquadrangular, nearly symmetrical bilaterally; margin angular or partially carinate. Segments few, more or less triangular in outline, embracing the three segments of the final convolution (with or without a single additional or nonspiral segment) forming almost the entire visible shell. Surface decked with exogenous costae, either distinct or in some parts combined so as to form an irregular reticulated ornament. Aperture a long bordered slit on the median line of the outer face of the terminal chamber.

"Length, one twenty-fifth inch (1 mm.)."

*Distribution*.—Bagg records this rare species from *Albatross* station H4694 in 865 fathoms off the Hawaiian Islands. I have examined Bagg's specimen from this station and agree with him in the determination. The specimen has a median aperture and the reticulated ornamentation mentioned by Brady, but not nearly as definitely shown in his figures as is the case in this specimen.

The finding of this species seems all the more remarkable as Bagg did not record *V. striata*, which has proved not to be uncommon about the Hawaiian Islands, as shown by the *Nero* material which I have examined.

## Genus NODOBACULARIA Rhumbler, 1895.

*Nubecularia* (part) JONES and PARKER, Quart. Journ. Geol. Soc., vol. 16, 1860, p. 455.—H. B. BRADY, Rep. Voy. *Challenger*, Zoology, vol. 9, 1884, p. 135.

*Nodobacularia* RHUMBLER, Nach. Ges. Wiss. Gottingen, 1895, p. 87 (Type *N. tibia* (Jones and Parker)); Zool. Jahrb., Abteil Syst., vol. 24, 1907, p. 37.

*Description*.—Test composed of a proloculum and second *Cornuspira*-like chamber, usually directly followed by a linear series of subcylindrical chambers; test imperforate, calcareous.

This genus apparently most common in the warm, shallow tropical seas is a very simple one developed from a *Cornuspira*-like early development. Most of the figured specimens seem to be megalo-spheric, and the microspheric form might possibly show developmental stages lacking in the megalospheric form of the species.

## NODOBACULARIA TIBIA, (Jones and Parker).

Plate 8, figs. 1, 2.

*Nubecularia tibia* JONES and PARKER, Quart. Journ. Geol. Soc., vol. 16, 1860, p. 455, pl. 20, figs. 48-51.—H. B. BRADY, Quart. Journ. Micr. Sci., vol. 19, 1879, p. 52, pl. 8, figs. 1, 2; Rep. Voy. *Challenger*, Zoology, vol. 9, 1884, p. 135, pl. 1, figs. 1-4.

*Description.*—Test composed of a globular proloculum followed, at least in the megalospheric form, by a second *Cornuspira*-like chamber a half coil in length, in turn followed by a series of two or three or more usually pyriform or subcylindrical chambers, the basal end being usually the broadest, tapering gradually to the apertural end; aperture simple, rounded occasionally with a somewhat thickened lip.

Length, usually less than 1 mm.

*Distribution.*—Among other localities Brady mentions the following *Challenger* records for the North Pacific: off the Philippines in 95 fathoms, and Inland Sea of Japan, 15 fathoms, not common.

**NODOBACULARIA IRREGULARIS Rhumbler.**

Plate 8, fig. 3.

*Nodobacularia irregularis* RHUMBLER, Zool. Jahrb., Abteil Syst., vol. 24, 1907, p. 38, pl. 2, fig. 15.

*Description.*—Test composed of an oval proloculum with a second, *Cornuspira*-like chamber a half coil in length, with the following chambers irregularly pyriform, extending back and on one side at least covering the distal portion of the previous chamber, apertural end tapering; wall smooth, aperture in later chambers complex, with a pore plate with numerous pores in addition to which there may be secondary apertural openings, usually near the outer angle of the base of the chamber but irregularly placed.

Length, 0.7 to 0.8 mm.

*Distribution.*—Rhumbler described this species from Laysan.

As noted by the author of the species this is somewhat intermediate between *Nodobacularia* and *Nubecularia* except that the chambers are uniserial. The irregularity and secondary openings are somewhat more like *Nubecularia*.

**Genus NUBECULARIA Defrance, 1825.**

*Nubecularia* DEFRANCE, Dict. Sci. Nat., vol. 35, 1825, p. 210 (Type *N. lucifuga* Defrance).—H. B. BRADY, Rep. Voy. *Challenger*, Zoology, vol. 9, 1884, p. 133.

*Description.*—Test typically coiled, planospiral, free or attached, consisting of an oval proloculum and second *Cornuspira*-like chamber of variable length, followed by several chambers irregular in shape and arrangement, but usually more or less distinctly planospiral, apertures one or more, irregularly arranged, wall smooth, roughened, or with incorporated sand grains.

As a rule the species of this genus are typical of the shallow waters of tropical and subtropical seas, attached to various objects or becoming free. The test is porcellanous and imperforate and the early stages show it to be a degenerate type from perhaps different sources within the family. The test, as is the case in so many attached forms, becomes highly irregular.

## NUBECULARIA LUCIFUGA Defrance.

Plate 8, fig. 6.

*Nubecularia lucifuga* DEFRANCE, Dict. Sci. Nat., vol. 25, 1825, p. 210, Atlas Zooph., pl. 44, fig. 3.—H. B. BRADY, Rep. Voy. *Challenger*, Zoology, vol. 9, 1884, p. 134, pl. 1, figs. 9–16.—MILLETT, Journ. Roy. Micr. Soc., 1898, p. 261, pl. 5, fig. 7.—SIDEBOTTOM, Mem. and Proc. Manchester Lit. and Philos. Soc., vol. 8, pt. 2, No. 5, 1904, p. 2, pl. 2, figs. 1–4.—RHUMBLER, Zool. Jahrb., Abteil Syst., vol. 24, 1907, p. 39, pl. 2, fig. 16.

*Description*.—Test free or attached, composed of the usual early planospiral chambers, after which the chambers become irregularly planospiral or highly irregular; wall porcellanous and imperforate; aperture one or several, rounded, irregularly placed, sutures in later chambers often indistinct.

*Distribution*.—Rhumbler records this species from Laysan. A figure after Rhumbler is here given (pl. 8, fig. 6). While the specimens are attached chambers are built with no calcareous floor, but as soon as they become free complete chambers are built and a secondary calcareous growth covers the remainder of the previously attached portion of the test.

## NUBECULARIA BRADYI Millett.

Plate 8, figs. 4, 5.

*Nubecularia inflata* H. B. BRADY (not *Nubecularia inflata* Terquem), Rep. Voy. *Challenger*, Zoology, vol. 9, 1884, p. 135, pl. 1, figs. 5–8.

*Nubecularia bradyi* MILLETT, Journ. Roy. Micr. Soc., 1898, p. 261, pl. 5, fig. 6.—SIDEBOTTOM, Mem. and Proc. Manchester Lit. and Philos. Soc., vol. 48, No. 5, 1904, p. 3.—RHUMBLER, Zool. Jahrb., Abteil Syst., vol. 24, 1907, p. 40, pl. 2, figs. 17–19.

*Description*.—"Test consisting of a few, misshapen, inflated segments, irregularly combined; aperture either single and simple, or more usually, consisting of a number of rounded orifices variously placed.

"Diameter, one-thirtieth inch (0.84 mm.) more or less."

*Distribution*.—The first of the localities mentioned for this species by Brady is off Honolulu coral reefs, Hawaiian Islands, in 40 fathoms. Rhumbler has the species from shore sands from Laysan. The description is from Brady, and the figures from Brady and Rhumbler.

## Subfamily 2. QUINQUELOCULININAE.

Test in the adult or in the early development of the test, at least in the microspheric form with the chambers a half coil in length and added in planes  $144^\circ$  from one another, five planes being necessary to complete a cycle before a new chamber is added directly above one of the previous ones, aperture at this stage at least alternately at opposite poles of the test.

While all the microspheric specimens of this group have the typical quinqueloculine development at least in the young, the adult characters in various genera have a wide range from the three planes,  $120^\circ$  apart in *Triloculina*, the two planes  $180^\circ$  apart in *Biloculina* to the unserial development of *Articulina*, the flattened form of *Hauerina*, etc. All, however, have a similar quinqueloculine development at least in the young of the microspheric form.

Genus QUINQUELOCULINA d'Orbigny, 1826.

*Quinqueloculina* D'ORBIGNY, Ann. Sci. Nat., vol. 7, 1826, p. 301. (Type *Q. seminulum* (Linnaeus)).

*Description.*—Test in the young with the usually oval proloculum and short, *Cornuspira*-like second chamber, followed by the adult character both in the microspheric and megalospheric forms of the species. This adult character consists of chambers a half coil in length added successively in planes  $144^\circ$  apart, five chambers being thus added before a cycle is completed and a new chamber added in the plane of the fifth preceding chamber and covering it exteriorly. The chambers are thus  $72^\circ$  from one another, but each as added is  $144^\circ$  from its immediately preceding one in the series; aperture typically elongate with a simple tooth and with little or no elongation of the neck except in certain of the more complex species.

From a study of the development of various genera of this subfamily it seems that d'Orbigny's characterization of the various genera *Quinqueloculina*, *Triloculina*, *Biloculina*, etc., was very strictly in accord with the actual relationships in the group. The later studies by Munier-Chalmas and Schlumberger show that the quinqueloculine development not only has a distinct generic significance but that it is phylogenetically very important in the development of the various generic types of this subfamily. A rather full discussion of the matter has already been given in the introductory pages and need not be repeated here.

QUINQUELOCULINA AGGLUTINANS d'Orbigny.

Plate 9, fig. 1.

*Quinqueloculina agglutinans* D'ORBIGNY, in De la Sagra, Hist. Fis. Pol. Nat. Cuba, 1839, "Foraminifères," p. 168, pl. 12, figs. 11-13.

*Miliolina agglutinans* SIDDALL, Cat. Brit. Rec. Foram., 1879, p. 4.—H. B. BRADY, Rep. Voy. Challenger, Zoology, vol. 9, 1884, p. 180, pl. 8, figs. 6, 7.

*Description.*—Test free, in the adult with five visible chambers, basal portion porcellanous, exterior rough, with agglutinated particles, usually calcareous, aperture oval, with a bifid tooth.

Length rarely more than 1 mm.

*Distribution.*—There seems to be no available published records from the North Pacific. I have had material definitely referable to this species from but three stations—off Japan; *Albatross*, D4874, in 66 fathoms and D4970 in 500 fathoms; and from Hongkong.



## QUINQUELOCULINA ALVEOLINIFORMIS, (H. B. Brady).

*Miliolina alveoliniformis* H. B. BRADY, Quart. Journ. Micr. Sci., vol. 19, 1879, p. 52; Rep. Voy. *Challenger*, Zoology, vol. 9, 1884, p. 181, pl. 8, figs. 15-20.

*Description*.—Test elongate, fusiform, composed of numerous chambers, long and narrow, five to eight visible from the exterior; wall in young specimens thin and porcellanous, in adults covered with sand grains; aperture composed of numerous pores or radiate, often indistinct.

Length, up to 2.5 mm.

*Distribution*.—From the known records of this species it is clearly one of warm shallow waters, especially characteristic of coral reefs. The only published record for the North Pacific is that given by Brady in the *Challenger* Report, coral reefs of Honolulu, Hawaiian Islands, in 40 fathoms. I have found the species fairly common in shallow-water material from Gaspar Straits, the largest fully 2.5 mm. in length, and from Apra Bay, Guam.

The relation of this species to others of the genus is not entirely apparent. The aperture is rather different from the typical *Quinqueloculina*, being usually cribrate, like *Hauerina*. A few other species, however, have this character. In some specimens the arrangement is quinqueloculine, but in the very largest ones this is somewhat obscured by the fact that the width of the chambers does not increase correspondingly with the length, and as a result the earlier chambers are left exposed and more than five chambers are visible. The specimens in the material I have had have often been worn or broken, and excellent material for detailed study has been rare.

## QUINQUELOCULINA AGGLUTINATA, new species.

Plate 9, fig. 2.

*Description*.—Test free, five visible chambers in the adult, wall on the exterior made up of agglutinated sand grains, with a smoothly finished exterior, chambers somewhat angled, the angles rounded, outer margin slightly convex, chambers broadest toward the base, tapering slightly toward the apertural end, neck not distinctly developed, flush with the base of the preceding chamber, aperture oval, with a simple flattened tooth, rather broad, with truncate or slightly rounded at the outer end.

Length, 0.60 to 0.90 mm.

*Distribution*.—Type-specimen Cat. No. 9158, U.S.N.M., and paratypes, all from a single station, full data not given, the material simply marked "Off Alaska." The species reminds one somewhat of *Q. bidentata* of d'Orbigny, but the apertural characters in all the specimens examined were very constant and decidedly different from that species. Perhaps it most resembles the subarctic form figured by Goës<sup>1</sup> under the name *Miliolina agglutinans*.

<sup>1</sup> Kongl. Svensk. Vet. Akad. Handlingar, vol. 25, 1894, pl. 19, figs. 848i-1.

## QUINQUELOCULINA SUBARENARIA, new species.

Plate 10, figs. 1, 2.

*Description*.—Test one and one-half times as long as wide, chambers distinct, sutures slightly depressed, peripheral margin broadly rounded, occasionally almost flattened, sides of chambers flattened or slightly concave, wall of the peripheral face smooth and polished, the sides arenaceous to the sutures, line between the side and peripheral faces usually somewhat irregular, apertural end slightly exserted, with a slight nearly circular neck, with a thin lip and a simple tooth, basal end of the last-formed chamber extending prominently beyond the preceding ones.

Length, up to 1.75 mm.

*Type-specimen*.—(No. 9159, U.S.N.M.) from 13 fathoms off Singapore. There were numerous other specimens of this species, with the type all of the same character.

## QUINQUELOCULINA ARENACEA (Rhumbler).

Plate 17, figs. 3, 4.

*Miliolina arenacea* RHUMBLER, Zool. Jahrb., Abteil. Syst., vol. 27, 1907, p. 43, pl. 3, figs. 24, 25.

*Description*.—Test free, elongate, elliptical, length about twice the width, usually quinqueloculine chambers narrow, so that sometimes as many as 6 or 7 chambers are visible from the exterior; the apertural end sharply contracted into a short neck at the end of which is the slitlike aperture; wall exteriorly composed of calcareous granules, hiding the calcareous basal shell material.

*Distribution*.—This species was described by Rhumbler from numerous specimens in the shore sands of Laysan.

This species differs from *Q. alveoliniformis*, which is somewhat resembles, in the simple aperture, the more elliptical form pointed ends and thickly set grains on the exterior.

## QUINQUELOCULINA SEMINULUM (Linnaeus).

Plate 11, fig. 2.

*Serpula seminulum* LINNAEUS, Syst. Nat., ed. 12, 1767, p. 1264, No. 791; 13th (Gmelin's) ed., 1788, p. 3739, No. 2.

*Quinqueloculina seminulum* D'ORBIGNY, Ann. Sci. Nat., vol. 7, 1826, p. 303, No. 44.

*Miliolina seminulum* WILLIAMSON, Rec. Foram. Great Britain, 1858, p. 85, pl. 7, figs. 183–185.—H. B. BRADY, Rep. Voy. *Challenger*, Zoology, vol. 9, 1884, p. 157, pl. 5, figs. 6a–c.

*Description*.—Test somewhat longer than broad, smooth, peripheral margins rounded, sutures distinct, apertural end not exserted, aperture fairly large, oval, with a simple tooth becoming bifid at the free end.

Length, up to 1.5 mm.

*Distribution.*—Specimens referable to this species were found at numerous localities in the western Pacific off Japan, Guam, and the Philippines. Brady records it in 40 fathoms off the coral reefs of Honolulu, Hawaiian Islands, and from two *Challenger* stations in deep water 244 in 2,900 and 253 in 3,125 fathoms.

The synonymy of this species is very large and very difficult to unravel, as the name has been used to include almost all sorts of smooth quinqueloculine forms. It is here used in the sense used by Brady and other British writers.

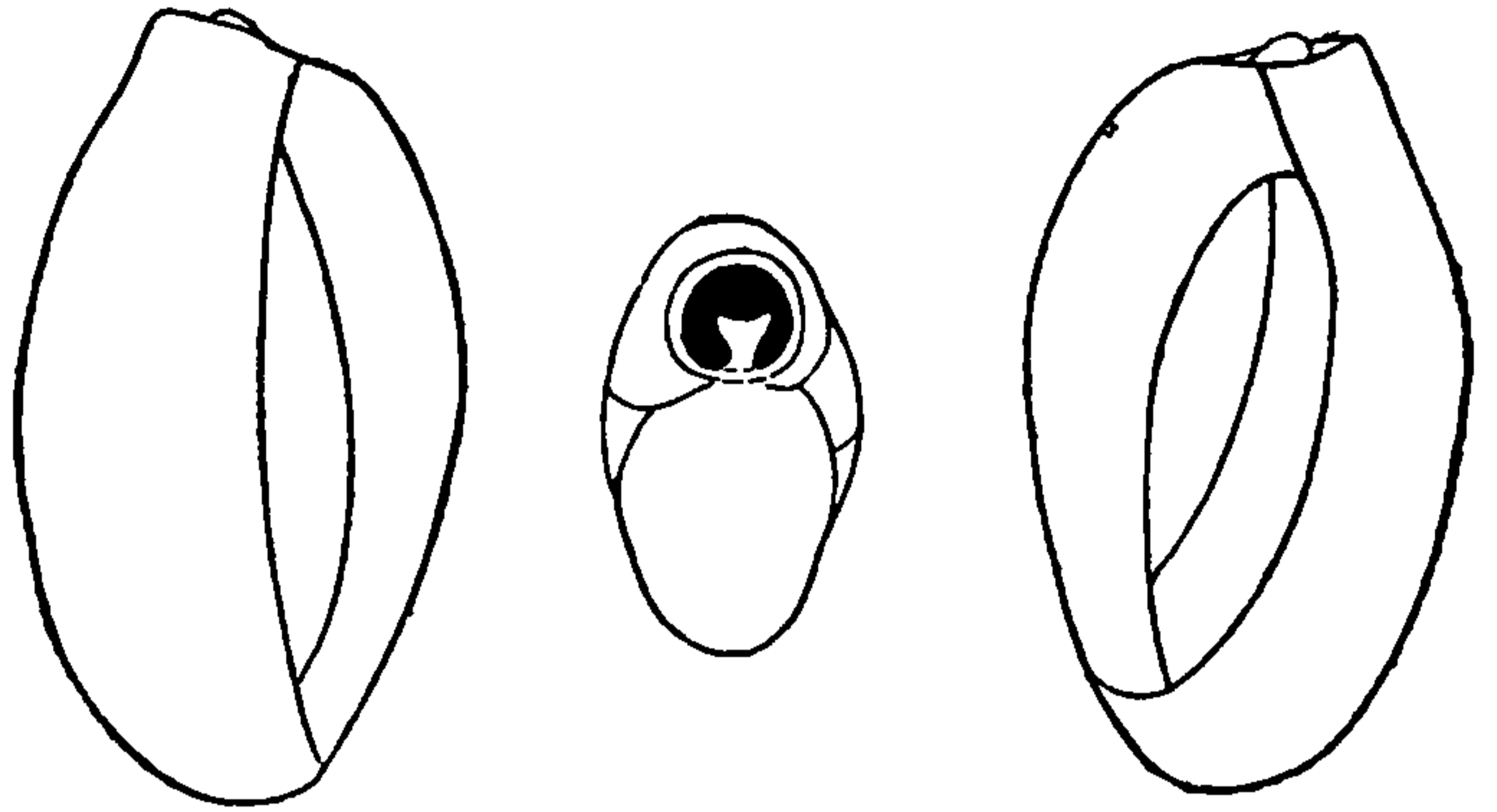

FIG. 29.—QUINQUELOCULINA SEMINULUM (LINNAEUS).  $\times 25$ .  
OUTLINES OF SPECIMEN FROM NERO STATION 1466 OFF GUAM.

#### QUINQUELOCULINA PROCERA (Goës).

Plate 19, fig. 2.

*Miliolina procera* Goës, Bull. Mus. Comp. Zoöl., vol. 29, 1896, p. 82, pl. 7, figs. 7-9.

*Description.*—Test comparatively large, thick, wall heavy, smooth, chambers tumid, distinct, sutures distinct but not deep, apertural end not at all exserted, aperture slightly depressed below the general surface, consisting usually of a transverse narrow slit more or less angled in a zigzag fashion, the lip but slightly developed and usually no definite tooth apparent.

Length, up to 2.40 mm.

*Distribution.*—Goës described this species from the eastern tropical Pacific, *Albatross* station 3,407 in 885 fathoms. I found abundant specimens of apparently the same species from *Albatross* station 3346 off the west coast of the United States.

This is a large and striking species and seems to be a distinct one, and in the Pacific at least, so far as material has shown, seems to be confined to the western coast of America.

#### QUINQUELOCULINA VENUSTA, Karrer.

Plate 11, fig. 1.

*Quinqueloculina venusta* KARRER, Sitz. Akad. Wiss. Wien, vol. 57, 1868, p. 147, pl. 2, fig. 6.

*Miliolina venusta* H. B. BRADY, Rep. Voy. *Challenger*, Zoology, vol. 9, 1884, p. 162, pl. 5, figs. 5, 7.—SHERBORN and CHAPMAN, Journ. Roy. Micr. Soc., 1889, p. 2, pl. 11, figs. 2, 3.—CHAPMAN, Journ. Roy. Micr. Soc., 1891, p. 573, pl. 9, figs. 5, 6.—EGGER, Abhandl. k. bay. Akad. Wiss. München, Cl. II, vol. 18, 1893, p. 235, pl. 2, figs. 56-58.

*Description.*—Test fusiform, quinqueloculine; one and one-half times as long as wide; chambers prominently triangular in transverse section, the peripheral margin bluntly angular, wall smooth; sutures not greatly depressed; apertural end somewhat produced to form a short contracted neck, nearly circular in section with a thickened lip and short simple tooth.

Length, usually less than 1 mm., one specimen nearly 2 mm. in length.

*Distribution.*—All the material I have had of this species in the North Pacific is from the region of the Hawaiian Islands, from three different sets of dredgings—*Albatross* H2922 in 268 fathoms, *Nero* 2034 in 175 fathoms, 2071 in 271 fathoms, and *Tuscarora* ½, in 206 fathoms, latitude 21° 10' N.; longitude 158° 04' W.

As a rule this species seems to be found in water of considerable depth and here it was not found in the shallow water of the same region. Brady records it from the North Pacific but without station.

QUINQUELOCULINA VULGARIS d'Orbigny.

Plate 11, fig. 3.

*Quinqueloculina vulgaris* D'ORBIGNY, Ann. Sci. Nat., vol. 7, 1826, p. 302, No. 33.—SCHLUMBERGER, Mém. Soc. Zool. France, 1893, p. 207; text figs. 13, 14, pl. 2, figs. 65, 66.

*Description.*—Test short and stout, about as long as wide, in front view orbicular, chambers in transverse section roughly triangular, the periphery bluntly angled, sides straight or slightly convex; sutures distinct, wall smooth; apertural end not contracted or produced; aperture elongate, narrow, with a tooth bifid at the tip, in front view projecting slightly above the border of the aperture.

Length, averaging about 0.75 mm.

*Distribution.*—This has seemed to be one of the most common species of this genus in the North Pacific, being found about the Hawaiian Islands, off Midway Island, off Guam, and at numerous points about Japan and between Guam and Japan in the *Nero* material especially.

QUINQUELOCULINA AUBERIANA d'Orbigny.

Plate 12, fig. 1.

*Quinqueloculina auberiana* D'ORBIGNY, in De la Sagra, Hist. Fis. Pol. Nat. Cuba, 1839, "Foraminifères" p. 167, pl. 12, figs. 1-3.

*Miliolina auberiana* H. B. BRADY, Rep. Voy. *Challenger*, Zoology, vol. 9, 1884, p. 162, pl. 5, figs. 8, 9.—GOËS, Kongl. Svensk. Vet.-Akad. Handl., vol. 25, 1894, p. 109, pl. 19, fig. 844a-d.

*Description.*—Test in front view oval, nearly as broad as long, in end view roughly triangular, quinqueloculine; chambers stout, roughly triangular in section, the periphery acutely angled, sides convex; apertural end very slightly produced, neck not visibly con-

tracted; aperture elongate oval, with a simple tooth, thickened somewhat at the tip.

Length up to and occasionally slightly exceeding 1 mm.

*Distribution.*—Specimens closely approximating the figures of d'Orbigny were obtained from *Tuscarora* stations 5/2 in 25 fathoms, latitude 32° 26' N.; longitude 140° 44' E. and 60 in 63 fathoms, latitude 21° 14' N.; longitude 157° 36' W.; from *Albatross* H3007 in 323 fathoms, off the Hawaiian Islands, and *Nero* 2033 in 249 fathoms in the same region; also from *Albatross* D4878 in 59 fathoms; D5055 in 124 fathoms and D5068 in 77 fathoms, all off Japan.

QUINQUELOCULINA CUVIERIANA d'Orbigny.

Plate 12, fig. 2.

*Quinqueloculina cuvieriana* D'ORBIGNY, in De la Sagra, Hist. Fis. Pol. Nat. Cuba, 1839, "Foraminiferes," p. 164, pl. 11, figs. 19-21.

*Description.*—Test clearly quinqueloculine, short and broad; sub-circular in front view, chambers sharply angled, the sides convex, the angles with usually two longitudinal costae very close to the peripheral angle, which is almost carinate, remainder of the chamber smooth; no apertural neck developed; aperture a narrow elongate or slightly curving opening, broadening slightly at the farther end, with a simple linear tooth nearly the length of the aperture.

Length, about 0.60 to 0.75 mm.

*Distribution.*—The only specimens referable to this species are from Hongkong in shallow water.

The specimens referred to this species by Brady and Baggs from the Hawaiian Islands lack the distinctive accessory carinal costae and are placed under *Q. lamarckiana* d'Orbigny. The form figured by Millett as *Miliolina cuvieriana* seems to be *Q. disparilis* of the short and more rounded variety described here as *var. curta*. Certainly it has little in common with the acute, almost carinate type of d'Orbigny, although it does have costae. Millett notes that none of the figures since d'Orbigny's, which have been placed under *Q. cuvieriana*, show any traces of the secondary costae which characterize the type.

QUINQUELOCULINA BICOSTATA d'Orbigny.

Plate 13, fig. 1.

*Quinqueloculina bicostata* D'ORBIGNY, in De la Sagra, Hist. Fis. Pol. Nat. Cuba, 1839, p. 195, pl. 12, figs. 8-10.

*Description.*—Test nearly as broad as long, chambers broad, sutures usually rather indistinct, peripheral margin in the earlier chambers sharply carinate, in adult specimens being bicostate, wall otherwise smooth, concave adjacent to the periphery, inflated near the inner margin, in end view decidedly angled; apertural end slightly if at all

produced; aperture nearly circular, with a smooth, slightly raised lip, tooth simple, not prominent.

Length, about 1 mm.

*Distribution*.—The only material referable to this species is from *Nero* station 1158 in 1,584 fathoms, between Yokohama and Guam.

QUINQUELOCULINA BICORNIS (Walker and Jacob).

Plate 13, fig. 2.

*Serpula bicornis* WALKER and JACOB, Adam's Essays, Kanmacher's Ed., 1798, p. 633, pl. 14, fig. 2.

*Miliolina bicornis* WILLIAMSON, Rec. Foram. Great Britain, 1858, p. 87, pl. 7, figs. 190–192.—H. B. BRADY, Rep. Voy. *Challenger*, Zoology, vol. 9, 1884, p. 171.

*Description*.—Test about one and one-half times as long as broad, chambers much the broadest at the basal end, tapering gradually to the periphery, chambers with three faces, the peripheral usually flattened or slightly concave, the sides flattened or slightly concave, ornamented with several prominent longitudinal costae, those separating the peripheral and side faces being particularly well developed; basal portion of the chamber usually projecting somewhat and rounded; apertural end produced into a short subcylindrical neck; aperture circular, with a slight lip and a single tooth.

Length, up to 2 mm.

*Distribution*.—Brady records this species from off the coral reefs of Honolulu, Hawaiian Islands. The only material I have had was from shallow water in Hongkong Harbor.

QUINQUELOCULINA BICORNIS (Walker and Jacob), var. ELEGANS Williamson.

*Miliolina bicornis*, var. *elegans* WILLIAMSON, Rec. Foram. Great Britain, 1858, p. 88, pl. 7, fig. 195.—H. B. BRADY, Rep. Voy. *Challenger*, Zoology, vol. 9, 1884, p. 171, pl. 6, figs. 9, 11, 12.—BAGG, Proc. U. S. Nat. Mus., vol. 34, 1908, p. 120.

This more slender variety is recorded in Bagg's paper without station from the Hawaiian Islands. An examination of his material shows a specimen of this form from *Albatross* station H4694, but the specimen is too broken to permit of figuring.

QUINQUELOCULINA DISPARILIS d'Orbigny.

Plate 14, fig. 1.

*Quinqueloculina disparilis* D'ORBIGNY, Ann. Sci. Nat., vol. 7, 1826, p. 302, No. 21.—SCHLUMBERGER, Mém. Soc. Zool. France, vol. 6, 1893, p. 212, pl. 2, figs. 55–57, figs. 21, 22 in text.

*Description*.—Test somewhat longer than broad, chambers very distinct, polygonal, consisting of an outer peripheral face which is flattened or slightly rounded and ornamented with several longitudinal costae, the side faces meeting the peripheral almost at right

angles, flattened or slightly concave, smooth and unornamented, basal end of the final chamber projecting nearly its whole width beyond the remainder of the test; apertural end truncate but without a neck; aperture with a slightly thickened lip and a simple tooth tending to a broadening or even slightly bifid condition at the free end.

Length, a little less than 1 mm.

*Distribution.*—The typical form of this species has occurred only at *Nero* station 1328, in 871 fathoms, between Yokohama and Guam.

**QUINQUELOCULINA DISPARILIS** d'Orbigny, var. **CURTA**, new variety.

Plate 14, fig. 2.

*Description.*—Variety larger and very much broader than the typical, nearly circular in front view; inner margin of the chambers somewhat convex and overlapping the previous ones.

Length, up to 2 mm.

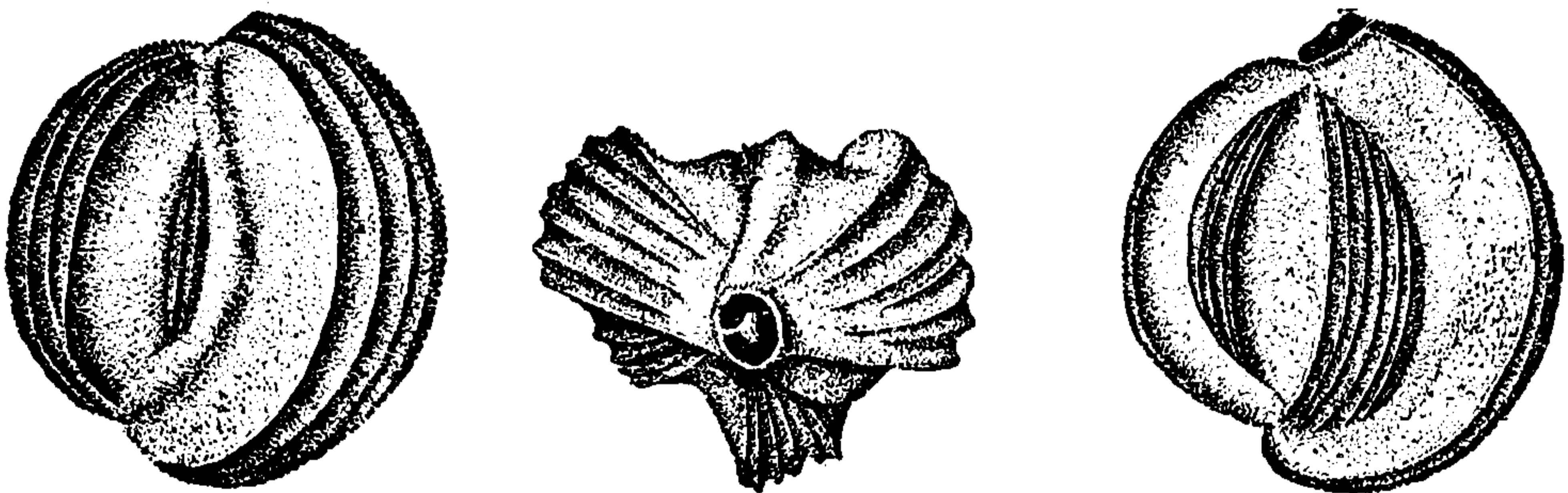

FIG. 30.—QUINQUELOCULINA DISPARILIS D'ORBIGNY, VAR. CURTA, NEW VARIETY.  $\times 18$ . SPECIMEN FROM "ALBATROSS" STATION 4900, OFF JAPAN.

*Distribution.*—Type-specimen (Cat. No. 9168, U.S.N.M.) from *Albatross* station D4900, in 139 fathoms, off Japan. At this station this variety was very common, and all the specimens were of this short stout form.

**QUINQUELOCULINA COSTATA** d'Orbigny.

Plate 15, fig. 1.

*Quinqueloculina costata* D'ORBIGNY, Ann. Sci. Nat., vol. 7, 1826, p. 301, No. 3.—  
TERQUEM, Mém. Soc. Geol. France, ser. 3, vol. 1, 1878, p. 63, pl. 6, figs. 3a-5c.

*Description.*—Test about twice as long as wide, elliptical or narrowly oval, chambers tumid, peripheral margin broadly rounded, sutures distinct but not deeply depressed, surface ornamented by numerous longitudinal, rather remote lines, apertural and exserted, with a slight neck tapering gradually from the peripheral curve, aperture broadly elliptical, basal end of the chamber broadly rounded, apertural end much darker than the remainder of the test.

Length, about 1 mm.

*Distribution.*—The only material of this species which I have had is from *Nero* stations 2039 in 24 fathoms and 2041 in 33 fathoms, Waimea Bay, Hawaiian Islands.

## QUINQUELOCULINA BOUEANA d'Orbigny.

Plate 15, fig. 2.

*Quinqueloculina boueana* D'ORBIGNY, Foram. Foss. Bass. Tert. Vienne, 1846, p. 293, pl. 19, figs. 7-9.

*Miliolina boueana* H. B. BRADY, Rep. Voy. *Challenger*, Zoology, vol. 9, 1884, p. 173, pl. 7, figs. 13a-c.

*Description*.—Test nearly as broad as long, chambers broad, distinct, sutures depressed, peripheral margin broadly rounded, last formed chamber not exerted at the apertural end, surface ornamented with numerous, distinct, longitudinal costae, aperture nearly circular, lip slightly thickened, with a simple tooth.

Length, usually less than 1 mm.

*Distribution*.—This species has occurred at *Nero* station 2041 in 33 fathoms in the vicinity of the Hawaiian Islands, *Nero* station 1466 off Guam in 234 fathoms, and at *Albatross* station D4900 in 139 fathoms off the coast of Japan.

## QUINQUELOCULINA PARKERI (H. B. Brady).

Plate 15, fig. 3.

"*Quinqueloculina* with oblique ridges" PARKER, Trans. Micr. Soc. London, vol. 6, 1858, p. 53, pl. 5, fig. 10.

*Miliolina parkeri* H. B. BRADY, Quart. Journ. Micr. Sci., vol. 21, 1881, p. 46; Rep. Voy. *Challenger*, Zoology, vol. 9, 1884, p. 177, pl. 7, fig. 14.

*Description*.—"Test elongate, subtriangular, quinqueloculine; peripheral margins of the segments sharp, with a tendency to become carinate; the surface of the chambers traversed by somewhat oblique transverse ridges or crenulations.

"Length, one twenty-fifth inch (1 mm.)."

*Distribution*.—This species seems to be, as noted by Brady, essentially a coral-reef species. In his tables of distribution he includes it from *Challenger* station 260A, in 40 fathoms off the coral reefs of Honolulu, Hawaiian Islands. Bagg also records it from this same region, *Albatross* D4000, in 104 to 213 fathoms, H4566, in 572 fathoms, and H4694 in 865 fathoms.\* Rhumbler records it from Laysan Island, a single specimen. I have examined Bagg's mounted material from the Hawaiian Islands, and it appears to be typical. In the material I have had from this same region I have found it but once, in material from *Nero* station 2039, in 24 fathoms. Typical specimens occur in shallow water material from Apra Bay, Guam, and from Gaspar Straits.

## QUINQUELOCULINA FERUSSACII d'Orbigny.

Plate 19, figs. 3, 4.

*Quinqueloculina ferussacii* D'ORBIGNY, Ann. Sci. Nat., vol. 7, 1826, p. 301, No. 18; Modèles No. 32.

*Miliolina ferussacii* H. B. BRADY, Rep. Voy. *Challenger*, Zoology, vol. 9, 1884, p. 175, pl. 113, figs. 17, a, b.



*Description.*—Test elongate, narrow, much drawn out at either end, chambers angular, usually the peripheral face of the later chambers with distinct costae, the last formed chamber with three, the one preceding with a single median one; wall smooth except for the costae; last formed chamber much extended at the apertural end, with a long narrow neck, aperture circular with a simple tooth.

Length, 1 mm. or less.

*Distribution.*—The species has been recorded from the North Pacific by Brady from *Challenger* station 260A in 40 fathoms from the coral reefs of Honolulu, Hawaiian Islands, and by Rhumbler from Laysan. I have had material from but two stations, both in the vicinity of the Hawaiian Islands, *Nero* 2047, in 217 fathoms, and 2071 in 271 fathoms.

These specimens are of the elongate compressed type, which agree with Brady's figures and with the model given by d'Orbigny. Many of the specimens referred to this species by later authors do not at all agree with the typical as represented by the model.

QUINQUELOCULINA AMYGDALOIDES (H. B. Brady).

*Miliolina amygdaloides* H. B. BRADY, Rep. Voy. *Challenger*, Zoology, vol. 9, 1884, p. 163, pl. 6, figs. 10, *a*, *b*.

*Description.*—"Test compressed, elongate-oval with tapering ends; one face nearly flat, the other convex and subangular; periphery sharp. Surface smooth, no external constrictions marking the margins of the chambers. Segments numerous, long and narrow; aperture circular, produced. Shell-wall thin and opalescent.

"Length, one-fiftieth inch (0.5 mm.) or less.

"This is a minute species but very uniform in its adult characters. The shell is exceedingly neatly made, but owing to the flush sutures the segmentation is always obscure. I know of no previously described form with which the specimens can properly be associated; the *Quinqueloculina pygmaea* of Reuss is perhaps the nearest, but the rounded chambers, excavated sutures, and generally larger size sufficiently distinguish that from the present species."

*Distribution.*—Brady described this species from comparatively shallow water in the vicinity of some of the Islands of the Pacific the only North Pacific one being from *Challenger* station 232 in 345 fathoms, on the *Hyalonema* ground south of Japan.

QUINQUELOCULINA DUTEMPLEI d'Orbigny.

Plate 18, figs. 1, 3.

*Quinqueloculina dutemplei* D'ORBIGNY, Foram. Foss. Vienne, 1846, p. 294, pl. 19, figs. 10-12.

*Description.*—Test quinqueloculine, one and at half times as long as wide, chambers sharply angled and carinate peripherally, wall coarsely and longitudinally striate; apertural end somewhat pro-

duced, basal end broadly rounded, little if at all extending beyond the previous chamber; aperture rounded with a slightly thickened lip and simple elongate tooth slightly bifid at the tip.

Length, slightly less than 1 mm.

*Distribution*.—Specimens from *Tuscarora* station 60, in latitude  $21^{\circ} 14' N.$ ; longitude  $157^{\circ} 36' W.$  in 63 fathoms near the Hawaiian Islands seem to belong to this species.

**QUINQUELOCULINA BRADYANA, new species.**

Plate 18, fig. 2.

*Miliolina undosa* H. B. BRADY (not *Quinqueloculina undosa* Karrer), Rep. Voy. Challenger, Zoology, vol. 9, 1884, p. 176, pl. 6, figs. 6-8.

*Description*.—Test stout, usually but slightly longer than broad, chambers angular, more or less plicated laterally, the outer peripheral angle usually sinuous, the early ones very prominently so; apertural end rarely extended to any considerable length, aperture usually narrow with a simple tooth.

Length, about 1 mm.

*Distribution*.—Brady's material was largely from shallow water material of the Indo-Pacific region. The material I have had has all been from comparatively shallow water about the Hawaiian Islands—type specimens, Cat. No. 9160, U. S. N. M., from *Nero* station 2039 in 24 fathoms and another lot from station 2070 in 285 fathoms.

This species does not seem to be at all identical with the *Q. undosa* of Karrer described from the Miocene of Austria. Brady himself notes various differences, as do later authors.

The figured specimen has the apertural end somewhat broken and therefore does not show clearly the complete apertural conditions.

**QUINQUELOCULINA UNDULATA d'Orbigny.**

*Quinqueloculina undulata* D'ORBIGNY, Ann. Sci. Nat., vol. 7, 1826, p. 302, No. 27.—SCHLUMBERGER, Mém. Zool. Soc. France, 1893, p. 213, text figs. 23, 24; pl. 1, figs. 53, 54; pl. 2, figs. 60, 61.—SIDEBOTTOM, Mem. Proc. Manchester Lit. and Philos. Soc., vol. 48, No. 5, 1904, p. 13.

*Description*.—Test irregularly oval in front view, nearly as broad as long, in the young with the chambers very strongly carinate and more or less undulate, sutures indistinct, in the adult becoming more regular; the sutures deeper and distinct, surface ornamented with rather coarse, slightly oblique, longitudinal striations, the chambers also transversely somewhat wrinkled; apertural end but slightly produced; aperture itself long and narrow with a long tooth, bifid at the tip.

Length, up to 1 mm.

*Distribution*.—The only material which seems to belong to this species is from *Nero* station 2033 in 249 fathoms off the Hawaiian

Islands. The sections figured by Schlumberger are very interesting in showing the smooth early chambers with the gradual development of the ornamentation, first with a single rib then two with a depression and finally in the adult a chamber with numerous ribs and striations on the peripheral portion.

QUINQUELOCULINA RUGOSA d'Orbigny.

*Quinqueloculina rugosa* D'ORBIGNY, Ann. Sci. Nat., vol. 7, 1826, p. 302, No. 24.—SCHLUMBERGER, Mém. Zool. Soc. France, 1893, p. 210, text figs. 18, 19, pl. 4, figs. 91-93.

*Description.*—Test fusiform, quinqueloculine, chambers of the adult quadrangular in transverse section, the periphery flattened and broad, the sides nearly at right angles to the peripheral face; in some cases both periphery and sides somewhat concave; wall slightly rugose, often with fine broken lines; apertural end slightly produced to form a short subcylindrical neck; aperture rounded, with a simple tooth.

Length, usually slightly less than 1 mm.

*Distribution.*—Specimens of this species were found sparingly in material from about the Hawaiian Islands, *Nero* station 2033 in 249 fathoms, 2036 in 82 fathoms, *Albatross* D4807, in 44 fathoms off Hakodate, Japan, D4900 in the Eastern Sea of Japan; also *Tuscarora* material from Manila Bay, Philippine Islands, and material from Hongkong Harbor.

In its early stages the chambers, as shown in figures given by Schlumberger, are smooth and rounded and show nothing of the adult character. This is the rule for species which are angled or ornamented in the adult and exactly what would be the case in any other group of animals.

QUINQUELOCULINA SUBROTUNDA (Montagu).

“*Serpula subrotunda dorso elevato*” WALKER and BOYS, Test Min., 1784, p. 2, pl. 1, fig. 4.

*Vermiculum subrotundum* MONTAGU, Test Brit., 1803, pt. 2, p. 521.

*Quinqueloculina subrotunda* D'ORBIGNY, Ann. Sci. Nat., vol. 7, 1826, p. 302, No. 36.—H. B. BRADY, Nat. Hist. Trans. Northumberland and Durham, vol. 1, 1865, p. 94, pl. 12, fig. 2.

*Miliola (Quinqueloculina) subrotunda* PARKER and JONES, Philos. Trans., vol. 155, 1865, p. 411, pl. 15, fig. 38.

*Miliolina subrotunda* H. B. BRADY, Rep. Voy. *Challenger*, Zoology, vol. 9, 1884, p. 168, pl. 5, figs. 10, 11.

Brady records this species from *Challenger* station 260A, in 40 fathoms, coral reefs of Honolulu, Hawaiian Islands, and Rhumbler from both Chatham Island and Laysan.

## QUINQUELOCULINA PYGMAEA Reuss.

*Quinqueloculina pygmaea* REUSS, Denkschr. Akad. Wien, vol. 1, 1850, p. 384, pl. 50, figs. 3a, b.

*Miliolina pygmaea* H. B. BRADY, Rep. Voy. *Challenger*, Zoology, vol. 9, 1884, p. 163, pl. 113, figs. 16, a, b.

*Distribution*.—To this species Brady refers specimens from the North Pacific from Hongkong Harbor and south of Japan.

## QUINQUELOCULINA FEROX (Rhumbler).

Plate 17, figs. 5–7.

*Miliolina ferox* RHUMBLER, Zool. Jahrb., Abteil. Syst., vol. 24, 1907, p. 47, pl. 3, figs. 29–31.

*Description*.—Test generally oval, quinqueloculine, generally smooth, sometimes with a tendency to longitudinal striations; aperture elongate, slit-like, narrow, tooth longitudinally more or less split up into distinct tooth-like projections.

Length, 0.6 to 0.9 mm.

*Distribution*.—Rhumbler described this species from shore sand of Laysan where it was frequent.

Typically the projections of the tooth are distinct at the tip as in figure 6, or occasionally they are united again above leaving a series of openings.

## QUINQUELOCULINA SPIRALIS, new species.

Plate 20, fig. 1.

*Description*.—Test elongate, twice as long as broad, quinqueloculine, chambers long and narrow, sutures distinct, peripheral margin bluntly angled, occasionally dividing into two blunt carinae with a peripheral depression; wall smooth; whole test twisted about the longitudinal axis, the chambers each making about a half turn; apertural end somewhat extended, especially on the peripheral edge, but only a slight contraction produced; aperture long and narrow with a straight simple tooth nearly the length of the aperture.

Length, 0.60 mm.

*Distribution*.—Type-specimen (Cat. No. 9161, U.S.N.M.) from *Nero* station 1466 in 234 fathoms off Guam.

This is a rather striking species in its spirally twisted contour, reminding one somewhat of certain of Terquem's, fossil species from Europe.

## QUINQUELOCULINA CULTRATA (H. B. Brady).

Plate 21, fig. 1.

*Miliolina cultrata* H. B. BRADY, Quart. Journ. Micr. Sci., vol. 21, 1881, p. 45; Rep. Voy. *Challenger*, Zoology, vol. 9, 1884, p. 161, pl. 5, figs. 1, 2.—EGGER, Abhandl. k. bay. Akad. Wiss. München, Cl. II, vol. 18, 1893, p. 231, pl. 2, figs. 29–31.—MILLETT, Journ. Roy. Micr. Soc., 1898, p. 269, pl. 6, figs. 11, 12.

*Description.*—Test compressed, at least twice as long as wide typically, chambers biconvex, the peripheral margin strongly carinate, wall smooth; apertural end considerably extended beyond the rest of the test in a sub-cylindrical slightly tapering neck, with a slight lip; aperture oval or elliptical with the tooth inconspicuous.

Length slightly less than 1 mm.

*Distribution.*—The records for this species are mainly from the Indo-Pacific region in comparatively shallow water. The only material I have had is from Hongkong Harbor in shallow water.

Although Brady starts his description with "Test Triloculine" the figures he gives are not triloculine, and those of Millett seem to indicate that possibly the species belongs to the genus *Massilina*, for his figure 12, above noted, has the final chambers distinctly in one plane. None of the specimens seem to be at all triloculine, thus substantiating the view already expressed that *Massilina* is a direct derivative from *Quinqueloculina*.

QUINQUELOCULINA MACILENTA (H. B. Brady).

*Miliolina macilenta*, H. B. BRADY, Rep. Voy. *Challenger*, Zoology, vol. 9, 1884, p. 167, pl. 7, figs. 5, 6.

*Description.*—"Test complanate, oval or discoidal; margin thin; resembling *Miliolina* [*Quinqueloculina*] in general contour and habit, but having a surface ornament of curved, parallel, longitudinal or somewhat obliquely-set costae.

"Length, one-fortieth inch (0.6 mm.)."

*Distribution.*—Brady described this species from three Pacific Stations of the *Challenger*, one of which, in 40 fathoms off Honolulu, Hawaiian Islands, is in the North Pacific, the others being in the South Pacific, Nares Harbor, Admiralty Islands, of 17 fathoms, and Humboldt Bay, New Guinea, 37 fathoms.

QUINQUELOCULINA RETICULATA (d'Orbigny).

Plate 16, figs. 1-3.

"*Frumentaria reticulata*" SOLDANI, Testaceographia, vol. 1, pt. 3, 1795, p. 233, pl. 159, figs. bb, cc.

*Triloculina reticulata* D'ORBIGNY, Ann. Sci. Nat., vol. 7, 1826, p. 299, No. 9.

*Quinqueloculina reticulata* KARRER, Sitz. Akad. Wiss. Wien, vol. 44, 1861, p. 449, pl. 2, fig. 5a, c.

*Miliolina reticulata* PARKER, JONES, and BRADY, Ann. Mag. Nat. Hist., ser. 4, vol. 8, 1871, p. 249, pl. 8, fig. 18.—H. B. BRADY, Rep. Voy. *Challenger*, Zoology, vol. 9, 1884, p. 177, pl. 9, figs. 2-4.—EGGER, Abhandl. k. bay. Akad. Wiss. München, Cl. II, vol. 18, 1893, p. 239, pl. 2, figs. 83, 84.—SCHLUMBERGER, Mém. Soc. Zool. France, vol. 6, 1893, p. 214, text fig. 25, pl. 2, fig. 62.

*Description.*—Test chiefly characterized by the reticulate character of the ornamentation consisting of oval depressions arranged in

lines lengthwise and diagonally, one side usually flattened; aperture elongated, typically with a long straight tooth occasionally inclined to be bifid at the tip.

Length, up to 1.5 mm.

*Distribution*.—In general this species is abundant in shallow tropical and subtropical waters, especially of coral reef regions. In the North Pacific Brady records it from Honolulu coral reefs, Hawaiian Islands, in 40 fathoms. In the material I have had it has occurred about the Hawaiian Islands at numerous stations, about Guam, Gaspar Straits, and Hongkong.

It seems very possible that more than one species may be represented in the reticulate series of this genus.

QUINQUELOCULINA (?) SCHAUINSLANDI (Rhumbler).

Plate 8, fig. 7, 8.

*Miliolina schauinslandi* RHUMBLER, Zool. Jahrb., Abteil. Syst., vol. 24, 1907, p. 41, pl. 3, figs. 20, 21.

*Description*.—Test with the early chambers quinqueloculine, later ones very irregular, in one plane usually; aperture large without teeth but with several, 3–5, or more irregular incurving somewhat pointed projections from the apertural border; wall smooth or variously wrinkled or roughened.

Length, 0.3 to 1.5 mm.

*Distribution*.—Rhumbler described this species from a few specimens from shore sands of Laysan. The only specimens I have had which seem identical are from *Nero* station 2039, in 24 fathoms, off the Hawaiian Islands.

Rhumbler compares the inwardly curving projections about the aperture to those seen in *Nevillina coronata*. From the Hawaiian specimen and those of *Nevillina* which I have seen the projections of this species seem to be entirely a portion of the lip of the aperture, while the ring of teeth of *Nevillina*, uniting as they do in the center, seem morphologically different and the resemblance only a superficial one.

Genus MASSILINA Schlumberger, 1893.

*Quinqueloculina* (in part) D'ORBIGNY, Ann. Sci. Nat., vol. 7, 1826, p. 303.

*Massilina* SCHLUMBERGER, Mém. Soc. Zool. France, 1893, p. 218 (type, *M. secans* (d'Orbigny)).

*Description*.—Test composed of a globular proloculum followed by a *Cornuspira*-like chamber, making a half coil, these in turn followed by a series of quinqueloculine chambers, in the adult composed of chambers arranged like *Spiroloculina* in a single plane, leaving the center open and the chambers a half coil in length.

This genus, which has already been described in some detail in the early pages, is derived from *Quinqueloculina*.

**MASSILINA SECANS (d'Orbigny).**

*Quiqueloculina secans* D'ORBIGNY, Ann. Sci. Nat., vol. 7, 1826, p. 303, No. 43.—  
PARKER, JONES, and BRADY, Ann. Mag. Nat. Hist., ser. 3, vol. 16, 1865,  
p. 34, pl. 1, fig. 10.

*Miliolina secans* H. B. BRADY, Rep. Voy. *Challenger*, Zoology, vol. 9, 1884, p. 167,  
pl. 6, figs. 1, 2.—SHERBORN and CHAPMAN, Journ. Roy. Micr. Soc., 1886,  
p. 742, pl. 14, fig. 4.—GOËS, Kongl. Svensk. Vet.-Akad. Handl., vol. 25,  
1894, p. 112, pl. 20, fig. 856.

*Massilina secans* SCHLUMBERGER, Mém. Soc. Zool. France, 1893, p. 218, text  
figs. 31-34, pl. 4, figs. 82, 83.—MILLETT, Journ. Roy. Micr. Soc., 1898, p. 608,  
pl. 13, fig. 3.

*Description.*—Test in its early development quinqueloculine, smooth, ovoid in shape, in the adult becoming broader, subcircular, relatively more compressed, the adult chambers often transversely plicated or granular, the periphery of the last-formed one often denticulate; aperture elongate, narrow, with a single tooth, bifid at the tip.

Length, up to 1 mm.

*Distribution.*—Brady records this species from a single North Pacific station, *Challenger* 260A, Honolulu coral reefs, Hawaiian Islands, in 40 fathoms.

**MASSILINA ANNECTENS Schlumberger.**

Plate 20, fig. 3.

*Massilina annectens* SCHLUMBERGER, Mém. Soc. Zool. France, 1893, p. 220, text  
figs. 35-37, pl. 3, figs. 77-79.—SIDEBOTTOM, Mem. Proc. Manchester Lit. and  
Philos. Soc., vol. 48, pt. 2, No. 5, 1904, p. 18, pl. 5, figs. 2-4.

*Description.*—Test broad, often broader than long, chambers quadrangular in section, periphery flattened or slightly concave, smooth except for occasional sand grains embedded in the wall, making the wall more or less roughened in spots; aperture rounded, with a single bifid tooth.

Length, about 0.8 mm.

*Distribution.*—The only North Pacific material I have had is from *Nero* station 2039, in 24 fathoms, off the Hawaiian Islands.

**MASSILINA CRENATA Karrer.**

Plate 20, fig. 2.

*Spiroloculina crenata* KARRER, Sitz. Akad. Wiss. Wien, vol. 57, 1868, p. 135,  
pl. 1, fig. 9.—H. B. BRADY, Rep. Voy. *Challenger*, Zoology, vol. 9, 1884,  
p. 156, pl. 10, figs. 24-26.—EGGER, Abhandl. k. bay. Akad. Wiss. München,  
Cl. II, vol. 18, 1893, p. 225, pl. 1, figs. 42, 43.

*Description.*—Test in its early development quinqueloculine, adult chambers in a single plane, in front view subelliptical, nearly as broad as long, compressed; chambers long and narrow, margin crenulate, due to the regular contractions or plications of the chamber in the adult; aperture rounded.

Length, up to 0.60 mm.

*Distribution.*—This small but attractive species is usually associated with coral-reef conditions in the shallow or comparatively shallow waters of tropical islands. Brady records it from the Pacific under such conditions. The material I have had is from *Nero* stations 2034 in 175 fathoms, 2042 in 55 fathoms, and 2070 in 285 fathoms, off Honolulu, Hawaiian Islands.

This species very evidently belongs to the genus *Massilina* instead of to *Spiroloculina*, as its early development seems to be invariably quinqueloculine, and it is only the last few chambers that are spiroloculine.

Genus ARTICULINA d'Orbigny, 1826.

*Nautilus* BATSCH (part), Conch. des Seesandes, 1791, p. 3.

*Articulina* D'ORBIGNY (type, *A. conico-articulata* (Batsch)), Ann. Sci. Nat., vol. 7, 1826, p. 300.—H. B. BRADY, Rep. Voy. *Challenger*, Zoology, vol. 9, 1884, p. 182.

*Vertebralina* PARKER, JONES, and H. B. BRADY (part), Ann. Mag. Nat. Hist., ser. 3, vol. 16, 1865, p. 22.

*Description.*—Early chambers usually quinqueloculine or triloculine, later ones in a uniserial arrangement, varying considerably in number according to the species; aperture in the adult a rounded, usually elliptical opening, in a depression with a definite phialine lip.

This genus is clearly a modification from *Triloculina* or *Quinqueloculina*, in which the early development shows clearly its relations to those genera, and the later development is an additional character similar and analogous to the uniserial development in *Bigenerina*, *Clavulina*, *Vaginulina*, etc. Such genera represent a final development along a specialized line, and the same is true here.

In some of the species the uniserial characters become relatively nearly the whole of the test, the triloculine or quinqueloculine portion being but a bulbous basal portion; in other species there is a rather even balance between the two portions. Those showing the greatest relative development of the uniserial portions may be definitely placed as the highest development of the genus.

ARTICULINA CONICO-ARTICULATA (Batsch).

Plate 22, fig. 6.

*Nautilus* (*Orthoceras*) *conico-articulatus* BATSCH, Conch. des Seesandes, 1791, p. 3, pl. 3, fig. 11.

*Vertebralina conico-articulata* PARKER, JONES, and H. B. BRADY, Ann. Mag. Nat. Hist., ser. 3, vol. 16, 1865, p. 22, pl. 1, fig. 2.—Goës (part), Abhandl. Kongl. Svensk. Vet. Akad. Handlingar, vol. 19, 1882, p. 121, pl. 9, figs. 317, 317*b*; Bull. Mus. Comp. Zoöl., vol. 29, 1896, p. 88.

*Articulina conico-articulata* H. B. BRADY, Rep. Voy. *Challenger*, Zoology, vol. 9, 1884, p. 185, pl. 12, figs. 17, 18; pl. 13, figs. 1, 2.—H. B. BRADY, PARKER, and JONES, Trans. Zool. Soc., vol. 12, 1888, p. 216, pl. 40, figs. 7–9.—EGGER, Abhandl. k. bay. Akad. Wiss. München, Cl. II, vol. 18, 1893, p. 224, pl.



3, fig. 2.—MILLETT, Journ. Roy. Micr. Soc., 1898, p. 511, pl. 12, figs. 9, 10 [??]

*Articulina nitida* D'ORBIGNY, Ann. Sci. Nat., vol. 7, 1826, p. 300, No. 1; Modèles, No. 22.

*Description*.—Test with the early chambers milioline, forming but a comparatively small part of the completed test, later chambers arranged in a linear series, chambers usually longer than wide, the lip flaring somewhat, nearly circular in cross section; wall with comparatively few costae; aperture nearly circular, with a smooth, flaring lip.

Length, up to 2 mm.

*Distribution*.—Apparently this species had not been definitely recorded from the North Pacific. The only material I have had is rather poor, from *Nero* station 2037, in 55 fathoms, off the Hawaiian Islands, from *Albatross* station H4829 in the eastern Pacific, and from Hongkong. In all cases the specimens were broken.

#### ARTICULINA SAGRA d'Orbigny.

Plate 22, figs. 7, 8.

*Articulina sagra* D'ORBIGNY, in De la Sagra, Hist. Fis. Pol. Nat. Cuba, 1839, Foraminifères, p. 160, pl. 9, figs. 23–26.—H. B. BRADY, Rep. Voy. *Challenger*, Zoology, vol. 9, 1884, p. 184, pl. 12, figs. 22–24.—Goës, Bull. Mus. Comp. Zoöl., vol. 29, 1896, p. 89.—FLINT, Rep. U. S. Nat. Mus., 1897 (1899), p. 301, pl. 47, fig. 1.—MILLETT, Journ. Roy. Micr. Soc., 1898, p. 511.—SIDEBOTTOM, Mem. and Proc. Manchester, Lit. and Philos. Soc., vol. 48, 1904, No. 5, p. 17, pl. 4, figs. 18–20; text fig. 6.

*Vertebralina sagra* Goës, Bull. Mus. Comp. Zoöl., vol. 29, 1896, p. 89.

*Description*.—Test with the early chambers milioline, later ones, usually two or three in a linear series, flattened, three or four or more times as wide as thick, apertural end broadened, somewhat flaring, curved, giving the appearance of several vertebrae, wall costate longitudinally; aperture narrowly elliptical, with a smooth projecting lip.

Length, up to about 1 mm.

*Distribution*.—Brady records the species from the coral reefs off Honolulu, Hawaiian Islands, in 40 fathoms. Neither Bagg nor Goës record this species from the Pacific. I have had material from *Nero* station 2071 in 271, fathoms, off the Hawaiian Islands, and from Gaspar Straits, North Pacific Exploring Expedition, Captain Rodgers. The species does not appear to be at all common, as it is in the West Indies, for example. Most of the material I have had was from deep water, however, and this may account for its apparent scarcity, although it should be found in shore sands of the tropical Pacific.

There seems to be some confusion with regard to the development of the species and many various forms have been assigned to it. A study of it from typical localities should help to straighten out these discrepancies.

## ARTICULINA SULCATA Reuss [?].

Plate 22, fig. 5.

*Articulina sulcata* REUSS, Denkschr. Akad. Wiss. Wien, vol. 1, 1849, p. 383, pl. 49, figs. 13-17.—H. B. BRADY, Rep. Voy. *Challenger*, Zoology, vol. 9, 1884, p. 183, pl. 12, figs. 12, 13.—H. B. BRADY, PARKER, and JONES, Trans. Zool. Soc., vol. 12, 1888, p. 215, pl. 40, fig. 11.—EGGER, Abhandl. köng. bay. Akad. Wiss. München, Cl. II, vol. 18, 1893, p. 243, pl. 2, fig. 5.—MILLETT, Journ. Roy. Micr. Soc., 1898, p. 510.

*Description*.—Test composed entirely of chambers without a linear series, milioline in arrangement; wall with few longitudinal costae; aperture with a flaring lip, projecting beyond the outline of the test, narrowly elliptical.

Length, 0.5 mm.

*Distribution*.—Brady records this species from off the reefs of Honolulu, Hawaiian Islands, in 40 fathoms. I have had material from *Nero* station 2071 in 271, fathoms, in the same region. The material I have had is very similar indeed to that figured by Brady, but it seems questionable as to whether either Brady's or our material really represent the species figured by Reuss. It seems more as though the recent material might be the young stage of something which had a further development, but material was very rare and too little for comparisons.

## Genus SIGMOILINA Schlumberger, 1887.

*Planispirina* (part) H. B. BRADY, Rep. Voy. *Challenger*, Zoology, vol. 9, 1884, p. 193.

*Sigmoidina* SCHLUMBERGER, Bull. Soc. Zool. France, vol. 12, 1887, p. 118.—(Type, *S. sigmoidea* (H. B. Brady)).

*Description*.—Test in its early stages quinqueloculine, later developing chambers a half coil in length in two series, with each newly added chamber in a plane more than 180° from the previous one, so that the horizontal plane in section shows a gradual turning about the elongate axis of the test, aperture typically with a single, simple tooth.

This genus is a rather curiously modified form with the increase in angle of addition to more than 180°, the chambers thus being added in an increasing spiral. After the inception of the curved line of addition the angle becomes nearly 180°, but the chambers are added, not directly outside the previous ones, as in other genera, such as *Biloculina* or *Spiroloculina*, but are added constantly at one side, giving the curve to the test in transverse section and exposing a number of chambers on the exterior of both sides.

## SIGMOLINA CELATA (Costa).

Plate 24, fig. 1.

*Spiroloculina celata* COSTA, Mem. Accad. Napoli, vol. 2, 1855, p. 126, pl. 1, fig. 14.*Planispirina celata* H. B. BRADY, Rep. Voy. *Challenger*, Zoology, vol. 9, 1884, p. 197, pl. 8, figs. 1-4.

*Description.*—Test oval or elliptical in front view, the ends rather pointed; in side view narrow, chambers numerous, two to a convolution, one side of the chamber convex, the other slightly concave and extending back over the previous ones of that side, giving the characteristic double curve to the test; wall on the outside composed of cemented sand grains, somewhat roughened, smooth and calcareous within; aperture transversely placed, often with a short, simple tooth.

Length, usually about 1 mm.

*Distribution.*—There is a single published record for the North Pacific, that given by Flint, from *Albatross* station 3080, in 93 fathoms, off the coast of Oregon. I have had a considerable number of stations represented in the material at my disposal; from the *Nero* material especially on the line between Guam and Japan. The stations range from 891 to 1,529 fathoms, from the *Albatross* material, about Japan in shallower water 139 to 437 fathoms, and from one *Tuscarora* station 58, in 814 fathoms, latitude 26° 52' N.; longitude 142° 21' E.

This species is much more common than the preceding, as a rule occurring in fairly deep water.

## SIGMOLINA SIGMOIDEA (H. B. Brady).

Plate 24, figs. 2, 3.

*Planispirina sigmoidea* H. B. BRADY, Rep. Voy. *Challenger*, Zoology, vol. 9, 1884, p. 197, pl. 2, figs. 1-3, woodcut, fig. 5c.

*Description.*—“Test free, oblong, with slightly projecting or pointed ends, the two faces unequally convex, peripheral edge thin, and slightly rounded; composed of numerous segments, two to each convolution, arranged on the milioline plan, the aperture alternately at either end of the shell. Segments, seldom exceeding 12 in number, arched longitudinally, and set at the outer margin of the alternate sides, the inner margin of the wall of each segment spreading over one lateral surface of the test, whilst the lateral extension of its successor in its turn covers the opposite side. Aperture, a curved transverse orifice in the prominence at the anterior end of the shell.

“Length, one-thirtieth inch (0.85 mm.)”

*Distribution.*—There are apparently no published records for this species from the North Pacific. I have had material from but five stations, *Nero* 649 in 762 fathoms, 990 in 859 fathoms, and 1320 in

2,048 fathoms, all in the general region of Guam; *Albatross* D4949 in 110 fathoms and H4882 in 248 fathoms, off Japan.

A transverse section from Brady shows well the characteristic doubly curving axis of the chambers as seen in the sectioned test.

Genus *HAUERINA* d'ORBIGNY, 1848.

*Hauerina* d'ORBIGNY (Type *H. compressa* d'Orbigny), *Foram. Foss. Bass. Tert. Vienne*, 1846, p. 119.—H. B. BRADY, *Rep. Voy. Challenger, Zoology*, vol. 9, 1884, p. 190.

*Description*.—Test compressed with the early chambers milioline, the later and greater portion of the test having the chambers arranged in a planospiral manner, usually in the last formed coil at least with more than two chambers in each whorl, surface smooth or ornamented; aperture of a large number of small pores forming a sieve-like plate, usually much longer than wide.

The Miocene species described by Brady and the type of the genus is a smooth species, with a thicker test than the recent species. It is from the Miocene of the Vienna Basin. Reuss has described a species from the Cretaceous as *Hauerina antiqua*, but it apparently is not a true *Hauerina*.

In recent waters the genus is apparently limited to the warmer portions of the Pacific and Indian Oceans.

*HAUERINA BRADYI*, new species.

Plate 23, fig. 2.

*Hauerina compressa* H. B. BRADY (not *H. compressa* d'Orbigny) *Rep. Voy. Challenger, Zoology*, vol. 9, 1884, p. 190, pl. 11, figs. 12, 13.—MILLETT, *Journ. Roy. Micr. Soc.*, 1898, p. 610, pl. 13, fig. 11.—RHUMBLER, *Zool. Jahrb., Abt. Syst.*, vol. 24, 1906, p. 52, pl. 3, fig. 39.

*Description*.—Test much compressed, the very earliest ones milioline, later ones becoming spiroloculine and finally in the last formed coil more than two chambers appear, usually three making up a complete coil; wall very finely striate-reticulate, periphery rounded or subcarinate, aperture a sieve-plate the entire height of the chamber, curved, with numerous pores.

Diameter, about 1 mm.

*Distribution*.—Rhumblert records two specimens of this species from Laysan Island. Otherwise it seems to have been unrecorded from the North Pacific. I have had excellent material, type, Cat. No. 9162 U.S.N.M., from Gaspar Straits (North Pacific Exploring Expedition, Captain Rodgers); from Hongkong; *Nero* stations 2042 in 55 fathoms and 2074 in 22 fathoms, off the Hawaiian Islands.

D'Orbigny figures a much less compressed form with more chambers in the final whorl, a smooth surface, the last formed coil making up a greater portion of the visible test and the milioline portion

much less distinct. In his figure of the apertural face there is a single large opening surrounded by numerous papillae, which are probably pores. Our recent species seems to be essentially different from that described by d'Orbigny in all its particulars. It is apparently a species of the tropical Indian and Pacific Oceans, with a possible extension to the Mediterranean from the data given by Sidebottom.<sup>1</sup> His specimens are very interesting and may be but a form of this species, as is suggested by him. Egger<sup>2</sup> records a thicker, more robust form from Mauritius. Millett records the species from the Malay Archipelago.

**HAUERINA CIRCINATA H. B. Brady.**

Plate 23, figs. 3, 4.

*Hauerina circinata* H. B. BRADY, Quart. Journ. Micr. Sci., vol. 21, 1881, p. 47; Rep. Voy. Challenger, Zoology, vol. 9, 1884, p. 191, pl. 11, figs. 14-16.—RHUMBLER, Zool. Jahrb., Abteil. Syst., vol. 24, 1906, p. 52, pl. 3, fig. 40.

*Description.*—"Test nautiloid, thin, complanate; composed of two or three convolutions, the last of which, consisting of six or seven segments, completely incloses those previously formed; segments arched, thin and rounded at their peripheral margins; sutural lines marked by external constrictions. Color milky white, sufficiently translucent to show the outline of the inner whorl of chambers. Aperture consisting of a number of perforations distributed irregularly over the septal face of the terminal segment.

"Diameter, one twenty-fifth inch (1 mm.)."

*Distribution.*—Rhumbler gives the only record for this species in the North Pacific, two specimens from Laysan Island. Brady's material was from shallow-water dredgings among the islands between Australia and Borneo.

From the figures and description given by Brady it seems as though this species was very different in its essential characters from typical *Hauerina* except in the matter of the aperture. Neither the figure nor the description give any light in regard to the structure and arrangement of the early chambers.

**HAUERINA ORNATISSIMA (Karrer).**

Plate 23, figs. 1, 5.

*Quinqueloculina ornatissima* KARRER, Sitz. Akad. Wiss. Wien, vol. 58, 1868, p. 151, pl. 3, fig. 2.—H. B. BRADY, Quart. Journ. Micr. Sci., vol. 16, 1876, p. 406.

*Hauerina ornatissima* H. B. BRADY, Rep. Voy. Challenger, Zoology, vol. 9, 1884, p. 192, pl. 7, figs. 15-22.—MILLETT, Journ. Roy. Micr. Soc., 1898, p. 610.—RHUMBLER, Zool. Jahrb., Abt. Syst., vol. 24, 1906, p. 53.

<sup>1</sup> Mem. and Proc. Manchester Lit. and Philos. Soc., vol. 48, 1904, No. 5, p. 19, pl. 5, figs. 7, 8, text fig. 8; vol. 54, 1910, No. 16, p. 6.

<sup>2</sup> Abhand. k. bay. Akad. Wiss. München, Cl. II, vol. 18, 1893, p. 244, pl. 3, figs. 9, 10, 23, 24.

*Description.*—Test compressed, early chambers milioline, later ones either embracing and extending in to the center to hide the previously formed chambers or becoming elongate and more or less encircling the periphery, surface ornamented by strong tranverse or radial crenulations crossed by numerous fine longitudinal striae, aperture consisting of numerous small pores in several linear series extending the full height of the chamber.

Diameter, up to 1.5 mm.

*Distribution.*—Rhumbler records this species from Laysan Island. This is the only published record for the North Pacific. I have had material from Gaspar Straits (North Pacific Exploring Expedition, Captain Rodgers), and from three *Nero* stations, 2041 in 33 fathoms, 2042 in 55 fathoms, and 2071 in 271 fathoms, all off the Hawaiian Islands.

This seems to be also a species of the Indo-Pacific region and is one of the most beautiful of the whole family of the Miliolidae. It is hard to believe that the specimens figured by Brady with involute chambers and the very open ones are both one species. In the latter it is not unusual to find specimens like that figured by Brady,<sup>1</sup> where the last formed chamber returns to the *Cornuspira*-like condition of its own young and has an unbroken chamber about the entire test.

**HAUERINA FRAGILISSIMA (H. B. Brady).**

Plate 24, fig. 4.

*Spiroloculina fragilissima* H. B. BRADY, Rep. Voy. *Challenger*, Zoology, vol. 9, 1884, p. 149, pl. 9, figs. 12-14.

*Hauerina fragilissima* MILLETT, Journ. Roy. Micr. Soc., 1898, p. 610, pl. 13, figs. 8-10.

*Description.*—“Test nearly circular, complanate, extremely thin; peripheral edge rounded. Segments numerous, much curved, the later ones in adult specimens nearly semicircular. Shell-wall delicately thin and opalescent, the sutures appearing as conspicuous white lines. Aperture cribrate.

“Diameter, one-thirtieth inch (0.8 mm.)”

*Distribution.*—This species has apparently not previously been recorded from the North Pacific. The only specimen I have seen is one from *Nero* station 2071 in 271 fathoms off the Hawaiian Islands. Brady records it from shallow water about the Society and Fiji Islands and about Borneo, and Millett records it from the Malay Archipelago.

**HAUERINA PACIFICA, new species.**

Plate 21, fig. 2.

*Description.*—Test irregularly suboval in front view, early chambers quinqueloculine, later ones nearly in one plane, slightly carinate, otherwise nearly circular in tranverse section, wall smooth, in the last-

<sup>1</sup> Rep. Voy. *Challenger*, Zoology, vol. 9, 1884, pl. 7, fig. 20.

formed coil usually four chambers required to form the whole volu-  
tion; aperture without neck or thickened lip, sieve-like, consisting of a  
circular plate, slightly convex, with numerous pores irregularly  
arranged.

Length, averaging about 0.75 mm.

*Distribution*.—Type specimen (Cat. No. 9163, U.S.N.M.) from *Nero*  
station 2039 in 24 fathoms, off the Hawaiian Islands. It also occurred  
commonly in material from nearby *Nero* stations, 2040 in 21 fathoms  
and 2041 in 33 fathoms.

The chambers of this species are not compressed and in many of  
the specimens are slightly more irregular than in the figured specimen.  
Specimens were common at all three of the above stations, but were  
not met with elsewhere. Apparently it is a shallow-water tropical  
species.

#### Genus TRILOCULINA d'Orbigny, 1826.

*Triloculina* D'ORBIGNY, Ann. Sci. Nat., vol. 7, 1826, p. 299 (Type *T. trigonula*  
(Lamarck)).

*Description*.—Test in its adult development consisting, as seen  
from the exterior, of three visible chambers added in planes 120° from  
one another, the third of each series added in the plane of the third  
preceding and covering it.

In its development it has been shown that in their microspheric  
form at least the species of *Triloculina* have a typical quinqueloculine  
development which precedes the adult triloculine condition. There-  
fore the young microspheric specimens of *Triloculina* may appear to  
be quinqueloculine and may possibly be mistaken for species of  
*Quinqueloculina* except for their association with adult *Triloculina*  
or possibly developing specific characters early enough to show their  
true relationships.

#### TRILOCULINA TRIGONULA (Lamarck).

Plate 25, fig. 3.

*Miliolites trigonula* LAMARCK, Ann. du Mus., vol. 5, 1804, p. 351, No. 3; Anim.  
sans Vert., vol. 7, 1822, p. 612, No. 3.

*Triloculina trigonula* D'ORBIGNY, Ann. Sci. Nat., vol. 7, 1826, p. 299, No. 1,  
pl. 16, figs. 5-9; Modèles, No. 93.

*Miliolina trigonula* WILLIAMSON, Rec. Foram. Great Britain, 1858, p. 83, pl. 7, figs.  
180-182.—H. B. BRADY, Rep. Voy. *Challenger*, Zoology, vol. 9, 1884, p.  
164, pl. 3, figs. 14-16.

*Description*.—Test in the adult with three visible chambers,  
smooth, the angles of the chambers rounded, whole test slightly  
longer than wide, in end view rounded triangular, the sides convex;  
aperture with a rather broad bifid tooth, the angles in end view  
rounded, in outline flattened.

Length usually about 1 mm.

*Distribution.*—Brady records a single North Pacific station for this species, *Challenger* station 260A in 40 fathoms on the coral reefs of Honolulu, Hawaiian Islands. Bagg records it from the following five *Albatross* stations in the vicinity of the Hawaiian Islands, D4000 in 104–213 fathoms, D4017 in 305 fathoms, D4025 in 275–368 fathoms,

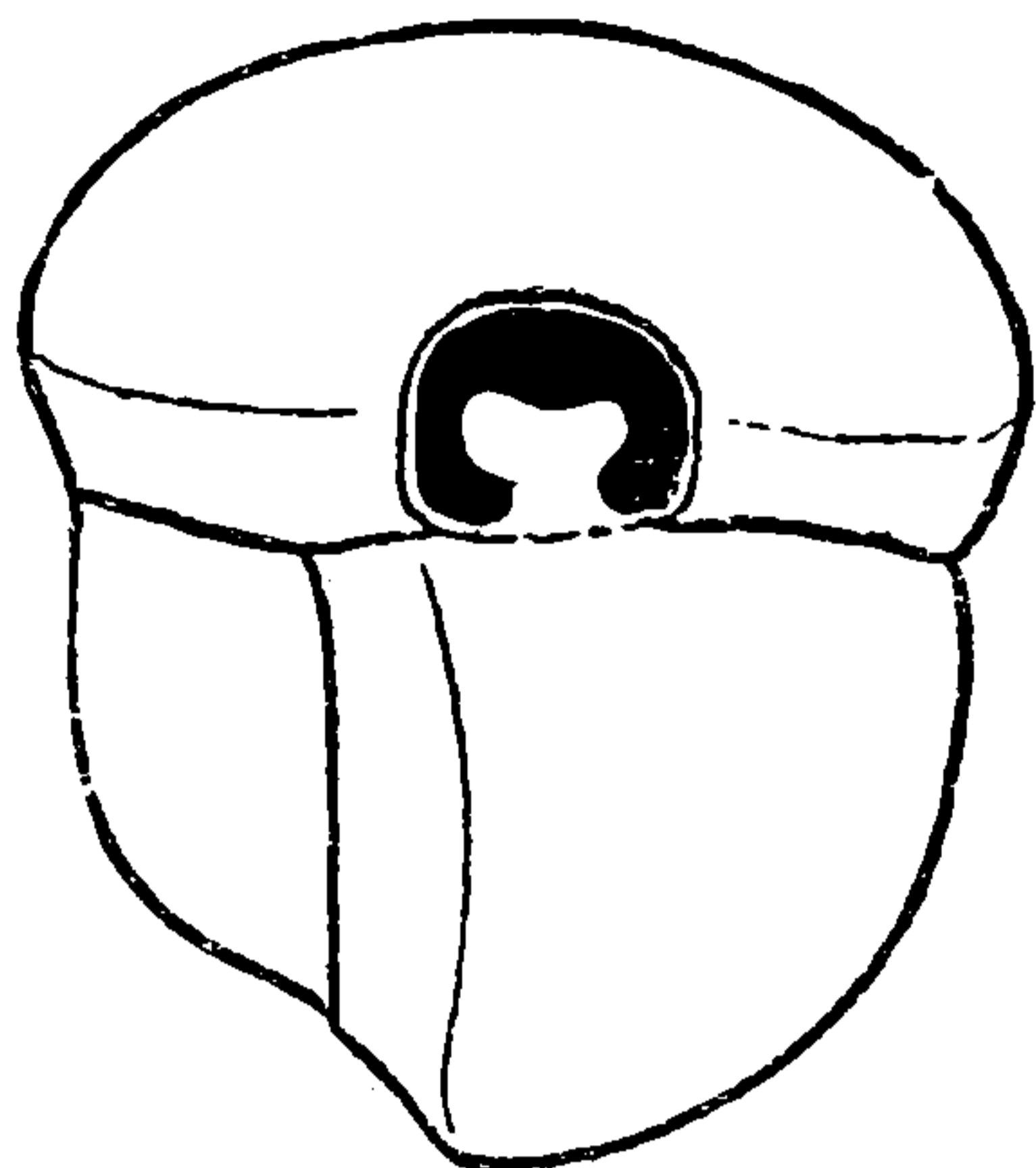

FIG. 31.—TRILOCULINA TRIGONULA (LAMARCK).  $\times 50$ . OUTLINE FIGURE SHOWING APERTURAL CHARACTERS.

H4568 in 1,274 fathoms, and H4696 in 367 fathoms. In the *Nero* material it has occurred about the Hawaiian Islands at two stations at 2041 in 33 fathoms and 2071 in 271 fathoms. In the *Albatross* material it was recorded off Japan at D4807 in 44 fathoms, D4900 in 139 fathoms, and D5068, Suruga Gulf, 77 fathoms, and in Colnett Strait in 316 fathoms. At one *Tuscarora* station 1/3 it occurred, latitude  $27^{\circ} 7' N.$ , longitude  $142^{\circ} 7' E.$  in 73 fathoms.

This species is distinguished from the following by the angles of the test which in this species are rounded and the sides convex.

Young specimens of *Biloculina* sometimes may be confused with this species but usually apertural or other characters will serve to distinguish them as well as the adults of *Biloculina* that they may be associated with.

#### TRILOCULINA TRICARINATA d'Orbigny.

Plate 25, figs. 1, 2.

*Triloculina tricarinata* D'ORBIGNY, Ann. Sci. Nat., vol. 7, 1826, p. 299, No. 7; Modeles, No. 94.—H. B. BRADY, Trans. Linn. Soc. London, vol. 24, 1864, p. 446, pl. 48, fig. 3.

*Miliolina tricarinata* H. B. BRADY, Rep. Voy. *Challenger*, Zoology, vol. 9, 1884, p. 165, pl. 3, fig. 17a, b.

*Description.*—Test in the adult with three visible chambers, smooth, the angles of the chambers sharply angled, almost carinate, whole test somewhat longer than wide, in end view triangular, the sides straight; aperture with a narrow bifid tooth.

Length, usually about 1 mm.

*Distribution.*—Goës records *T. tricarinata* from a single *Albatross* station, 3433 in 1,218 fathoms. Bagg records it from the following four *Albatross* stations near the Hawaiian Islands: D4000 in 104 to 213 fathoms, D4025 in 275 to 368 fathoms, D4174 in 735 to 865 fathoms, and H4694 in 865 fathoms. In the North Pacific material I have examined the species has occurred about the Hawaiian Islands, Midway Island, Guam, and at a number of stations off Japan. These stations range as low as 1,850 fathoms.



As a rule *T. tricarinata* seems to be found in deeper water than its closely allied species, *T. trigonula*.

From one station, D5056 off Japan in 258 fathoms, very large specimens occur with a cruciate aperture similar to the species named by

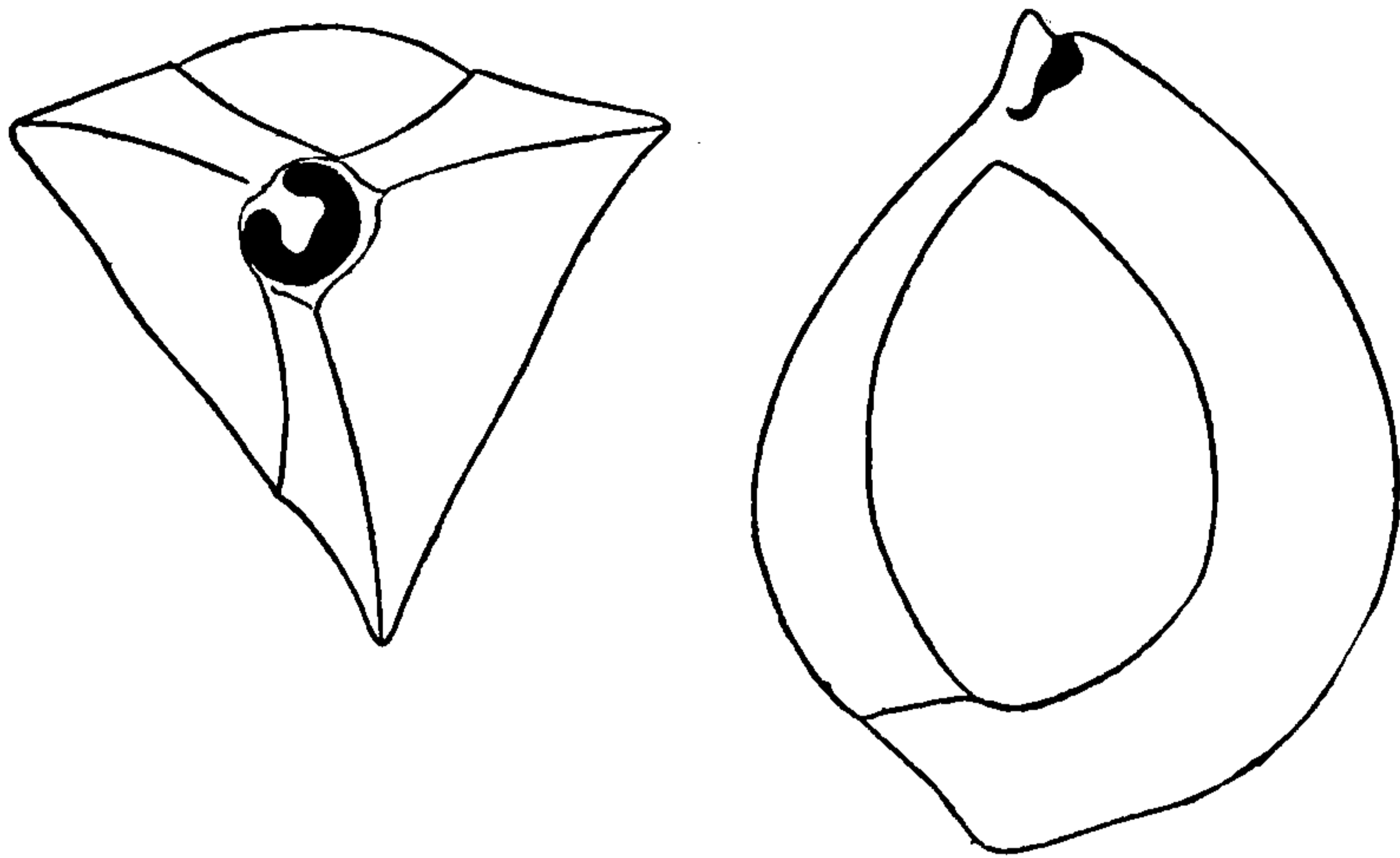

FIG. 32.—TRILOCULINA TRICARINATA D'ORBIGNY.  $\times 13$ . OUTLINE FIGURE SHOWING THE APERTURAL CHARACTERS.

d'Orbigny *Cruciloculina triangularis*. Sufficient material was not available for a study of the young stages to compare them with similar stages of smaller specimens of *T. tricarinata*.

**TRILOCULINA CIRCULARIS Bornemann.**

Plate 25, fig. 4; plate 26, fig. 1.

*Triloculina circularis* BORNEMANN, Zeitschr. deutsch. geol. Ges., vol. 7, 1855, p. 349, pl. 19, fig. 4.

*Miliolina circularis* H. B. BRADY, Rep. Voy. Challenger, Zoology, vol. 9, 1884, p. 169, pl. 4, fig. 3a-c; pl. 5, figs. 13, 14?—Goës, Bull. Mus. Comp. Zoöl., vol. 29, 1896, p. 82.

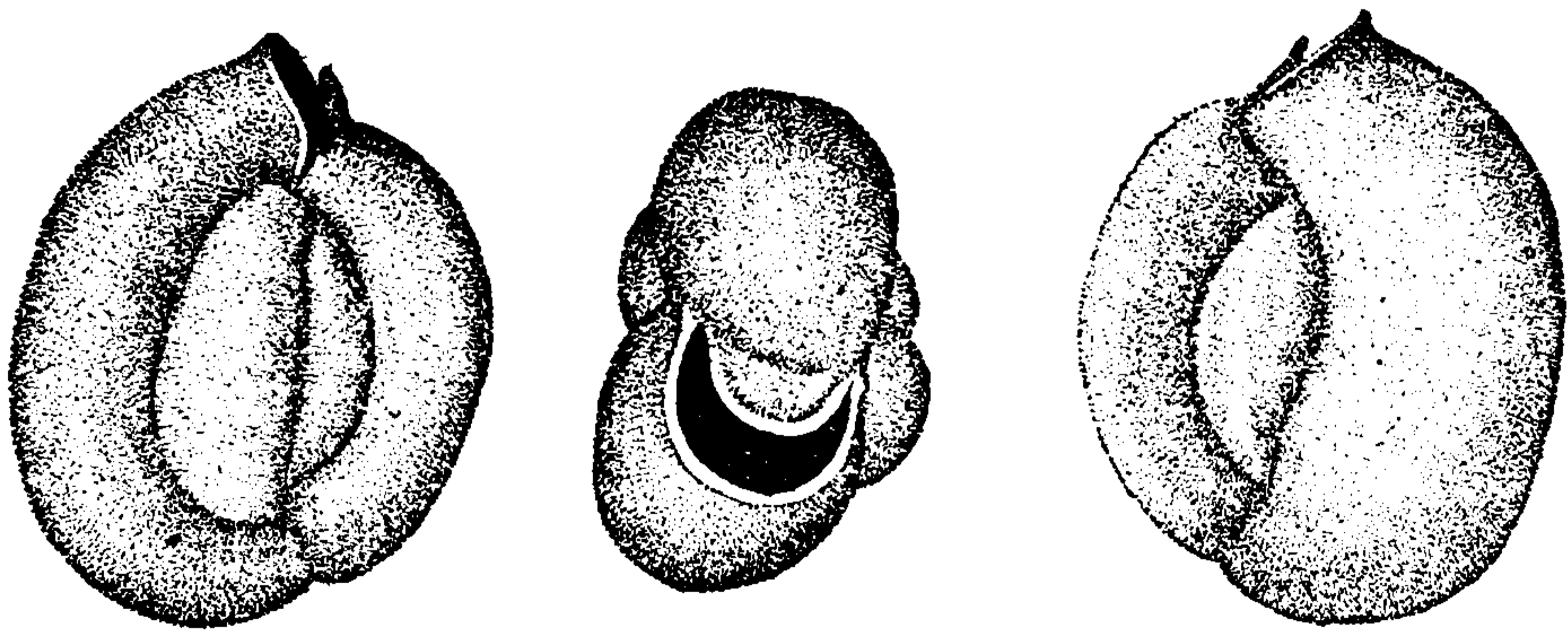

FIG. 33.—TRILOCULINA CIRCULARIS (BORNEMANN).  $\times 36$ . YOUNG SPECIMEN STILL IN THE QUINQUELOCULINE STAGE FROM HONGKONG HARBOR.

*Description*.—Test rounded, the three visible chambers in the adult rounded and tumid, sutures distinct, whole test somewhat compressed, the last-formed chamber strongly embracing, wall smooth; aperture a crescentiform narrow slit with a large flattened semicircular tooth.

Length, about 1 mm.

*Distribution*.—The only definite published North Pacific record for this species seems to be that given by Goës, *Albatross* D3407 in 885

fathoms, off the western coast of tropical America. It has occurred frequently, in the material I have had, off Alaska, about the Hawaiian Islands, near the Galapagos, off Guam, and at numerous stations off Japan. These for the most part have been in comparatively shallow water, ranging from 21 to 316 fathoms.

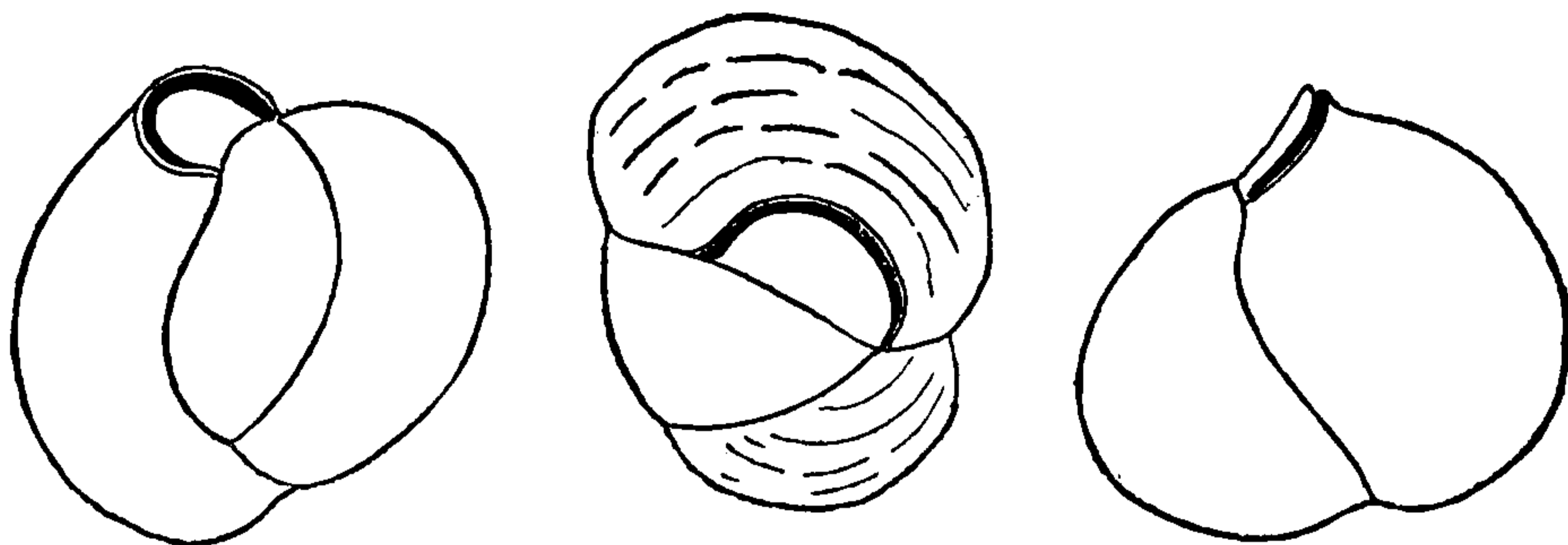

FIG. 34.—*TRILOCULINA CIRCULARIS* (BORNEMANN).  $\times 13$ . ADULT SPECIMEN SHOWING THE TRILOCULINE CHARACTER IN THE FULLY DEVELOPED SPECIMEN.

The species seems to be definitely triloculine in its fully developed condition, although as might be expected from its development the early stages are quinqueloculine. The apertural characters are rather striking.

***TRILOCULINA CIRCULARIS* Bornemann, var. *SUBLINEATA* (H. B. Brady).**

Plate 26, fig. 2.

*Miliolina circularis* BORNEMANN, var. *sublineata* H. B. Brady, Rep. Voy. Challenger, Zoology, vol. 9, 1884, p. 169, pl. 4, fig. 7a-c.

*Description*.—“Similar in general contour, disposition of segments, form of aperture, and dimensions to *Miliolina circularis*. Shell thin and often subtranslucent; decorated with a surface ornament of delicate, interrupted, longitudinal striae.”

*Distribution*.—Brady described this variety from a single Challenger station, off the Admiralty Islands, on the north coast of New Guinea in 15 to 25 fathoms. The material I have had has come from two Albatross stations, D4807 in 44 fathoms and D4900 in 139 fathoms, both off the coast of Japan.

The specimens are very similar to those figured by Brady, most of them even more so than the figured specimen, in which the surface striae are rather more prominent than usual.

***TRILOCULINA CYLINDRICA* Fornasini.**

Plate 17, fig. 10.

*Triloculina cylindrica* D'ORBIGNY (fide Fornasini), Ann. Sci. Nat., vol. 7, 1826, p. 300, No. 19.—FORNASINI, Mem. Accad. Sci. Istit. Bologna, ser. 6, vol. 2, 1905, p. 61, pl. 1, figs. 13a-b.

*Miliolina cylindrica* RHUMBLER, Zool. Jahrb., Abteil. Syst., vol. 24, 1907, p. 50, pl. 3, fig. 36.

*Distribution*.—Rhumbler records a few specimens from Chatham Island which he refers to this species.

The accompanying figure is from Rhumbler.

## TRILUCULINA OBLONGA (Montagu).

Plate 26, fig. 3.

*Vermiculum oblongum* MONTAGU, Test. Brit., 1903, p. 522, pl. 14, fig. 9.*Triloculina oblonga* D'ORBIGNY, Ann. Sci. Nat., vol. 7, 1826, p. 300, No. 16; Modèles, No. 95; in De la Sagra, Hist. Fis. Pol. Nat. Cuba, 1839, "Foraminifères," p. 155, pl. 10, figs. 3-5.*Miliolina oblonga* H. B. BRADY, Rep. Voy. *Challenger*, Zoology, vol. 9, 1884, p. 160, pl. 5, fig. 4a, b.—BAGG, Proc. U. S. Nat. Mus., vol. 34, 1908, p. 121.

*Description.*—Test elongate, the adult with three visible chambers, last formed chamber broadest near the initial end and longer than the preceding ones; test in end view triangular, the angles broadly curved, chambers tumid, sutures distinct; wall smooth and unornamented; aperture oval with the tooth simple or narrow and bifid at the tip.

Length, usually less than 1 mm.

*Distribution.*—Brady has two *Challenger* records of this species from the North Pacific, 260A, in 40 fathoms, coral reefs of Honolulu, Hawaiian Islands, and 244 in 2,900 fathoms. Bagg records it at one station, *Albatross*, D4000 in 104 to 213 fathoms off the Hawaiian

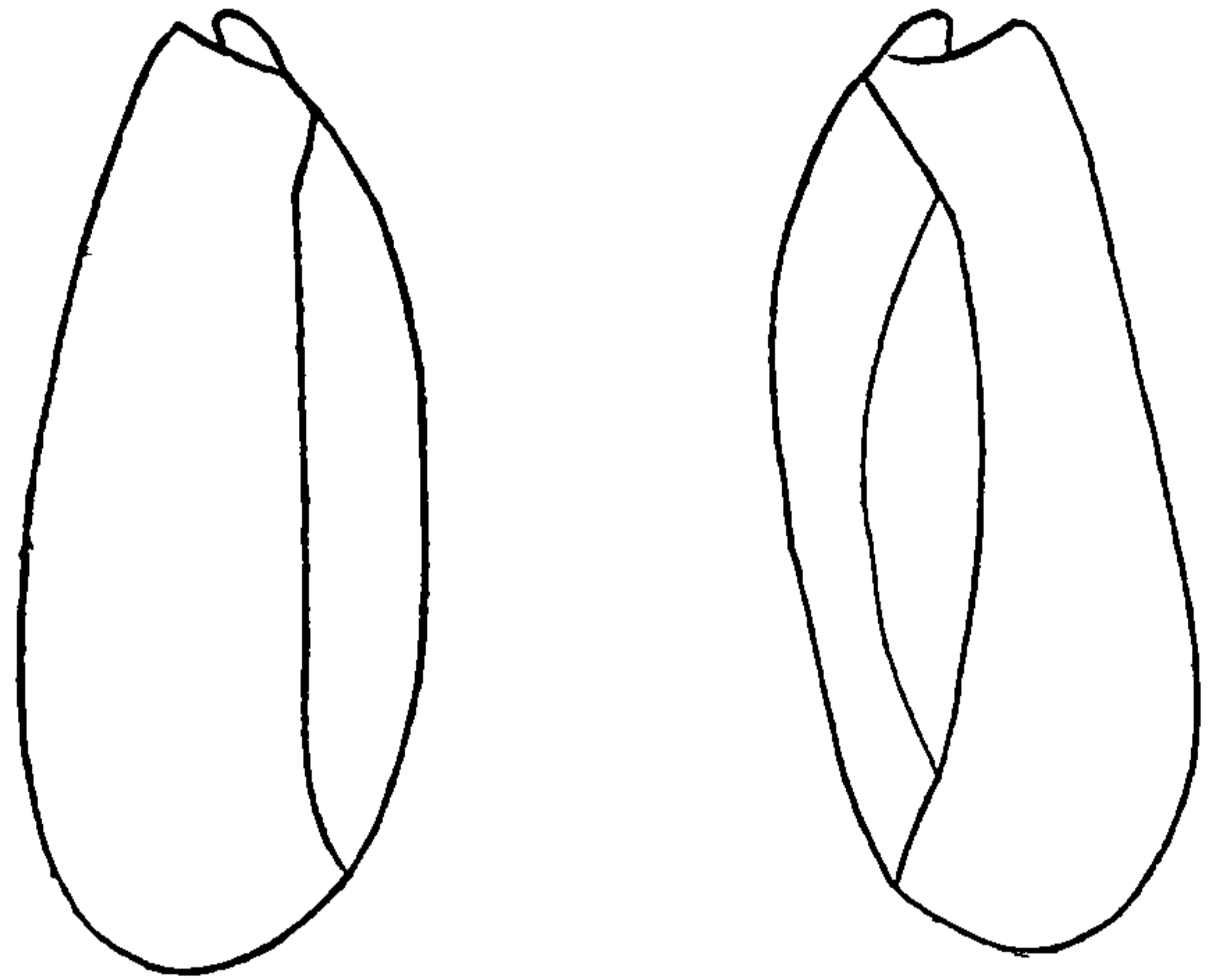

FIG. 35.—TRILUCULINA OBLONGA D'ORBIGNY.  $\times 25$ . OUTLINE OF CHAMBERS OF SPECIMEN FROM "NERO" 2071 IN 271 FATHOMS OFF THE HAWAIIAN ISLANDS.

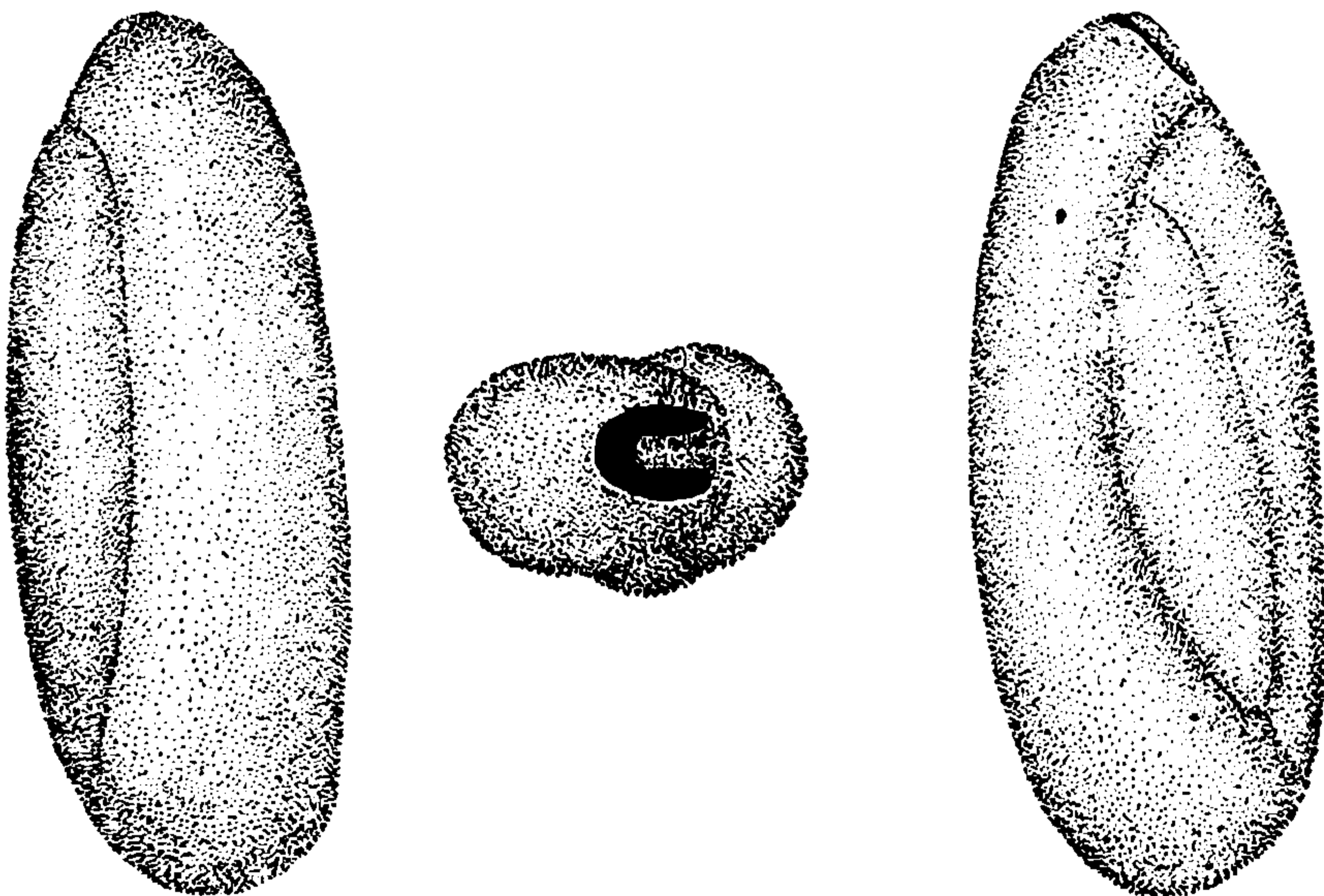

FIG. 36.—TRILUCULINA OBLONGA D'ORBIGNY.  $\times 100$ . MUCH SMALLER SPECIMEN THAN THAT SHOWN IN FIG. 35, FROM THE SAME STATION, BUT THE TRILUCULINE CHARACTERS FULLY DEVELOPED.

Islands. The material I have had is distributed as follows: Several *Albatross* and *Nero* stations in the vicinity of the Hawaiian Islands, *Nero* station 1466 in 234 fathoms off Guam, and *Tuscarora* material from Manila Bay, Philippine Islands.

## TRILOCULINA SUBORBICULARIS d'Orbigny.

Plate 21, fig. 3.

*Quinqueloculina suborbicularis* D'ORBIGNY, Ann. Sci. Nat., vol. 7, 1826, p. 302, No. 29.—SCHLUMBERGER, Mém. Soc. Zool. France, 1893, p. 215, text figs. 26–28; pl. 2, figs. 63, 64; pl. 3, fig. 67.

*Triloculina suborbicularis* D'ORBIGNY, Ann. Sci. Nat., vol. 7, 1826, p. 300, No. 12; in De la Sagra, Hist. Fis. Pol. Nat. Cuba, 1839, "Foraminifères," p. 177, pl. 10, figs. 9–11.

*Description.*—Test suborbicular, much compressed laterally, breadth as great or greater than the length, chambers rounded on the peripheral margin, wall longitudinally striate, earliest ones smooth, aperture subcircular with a flattened lip, tooth simple, semicircular at some distance in front of the aperture itself, apparently on the chamber of the preceding coil.

Diameter, usually less than 1 mm.

*Distribution.*—Specimens closely approximating those figured by Schlumberger were found at *Nero* station 2074 in 22 fathoms off the Hawaiian Islands. These seem very different from the preceding species. Most of the specimens were apparently still in their quinqueloculine stage.

## TRILOCULINA DEPLANATA (Rhumbler).

Plate 17, fig. 2.

*Miliolina deplanata* RHUMBLER, Zool. Jahrb., Abteil. Syst., vol. 24, 1907, p. 42, pl. 3, figs. 23, 23a.

*Description.*—Test triloculine, elongate, elliptical, nearly twice as long as broad, somewhat compressed; sutures very shallow and delicate; aperture an elongate slit, with a single somewhat prominent tooth, slightly raised above the level of the apertural lip.

Length, 0.24 to 0.45 mm.

*Distribution.*—Rhumbler described this species from a few specimens from Laysan. I have had no material strictly referable to it.

## TRILOCULINA LABIOSA d'Orbigny.

*Triloculina labiosa* D'ORBIGNY, in De La Sagra, Hist. Fis. Pol. Nat. Cuba, 1839, "Foraminifères" p. 157, pl. 10, figs. 12–14.

*Miliolina labiosa* H. B. BRADY, Rep. Voy. *Challenger*, Zoology, vol. 9, 1884, p. 170, pl. 6, figs. 3–5.

Brady records this species from very deep water in the North Pacific, the tests in the deepest water being completely siliceous. The depths of these stations range from 2,050 to 3,950 fathoms. The same species is recorded by Brady from *Challenger* station 260A in 40 fathoms, coral reefs of Honolulu, Hawaiian Islands.

## TRILOCULINA FICHELIANA d'Orbigny.

*Triloculina fichteliana* D'ORBIGNY, in De la Sagra, Hist. Fis. Pol. Nat. Cuba, 1839, "Foraminifères," p. 152, pl. 9, figs. 8-10.

*Miliolina fichteliana* H. B. BRADY, Rep. Voy. *Challenger*, Zoology, vol. 9, 1884, p. 169, pl. 4, fig. 9a-c.

*Description*.—Test in the adult triloculine, somewhat wider than long, the chambers rotund, peripheral margin rounded, sutures deep and conspicuous, wall longitudinally striate, apertural end little if at all produced; aperture rather large, rounded, with a simple tooth and a slightly developed thickened lip.

Length, up to 1.5 mm.

*Distribution*.—Brady gives among his localities for this species the following from the North Pacific "in dredged sand from the Inland Sea of Japan, 14 fathoms, and from the Chinese Sea."

Although Brady lumps together *T. fichteliana* d'Orbigny and *T. suborbicularis* d'Orbigny, as well as *T. webbiana* d'Orbigny, there seems to be some essential differences between the first and second species at least, and the material I have had from the Hawaiian Islands belongs to the second species.

## TRILOCULINA CUNEATA Karrer.

Plate 17, fig. 1.

*Triloculina cuneata* KARRER, Sitz. Akad. Wiss. Wien, vol. 55, Abteil, 1867, p. 359, pl. 2, fig. 8.

*Miliolina cuneata* RHUMBLER, Zool. Jahrb., Abteil. Syst., vol. 24, 1907, p. 42, pl. 3, fig. 22.

Rhumbler records and figures a single specimen from Laysan which he refers to this species. The specimen, the figure of which is reproduced here, shows but two visible chambers on either side, as do certain of Brady's figures referred to this species as a "Biloculine variety." As this single specimen gives little information as to the relation of this species, it is simply recorded here.

## TRILOCULINA CRIBROSTOMA (Rhumbler).

Plate 17, fig. 8.

*Miliolina cribrostoma* RHUMBLER, Zool. Jahrb., Abteil. Syst., vol. 24, 1907, p. 47, pl. 3, fig. 32.

*Description*.—Test elongate, about twice as long as wide, elliptical, longitudinally striate; aperture sieve-like.

Length, 0.39 to 0.54 mm.

*Distribution*.—Rhumbler described this species from numerous specimens found in shore sands from Laysan.

## TRILOCULINA TERQUEMIANA (H. B. Brady).

Plate 27, fig. 2.

*Miliolina terquemiana* H. B. BRADY, Rep. Voy. *Challenger*, Zoology, vol. 9, 1884, p. 166, pl. 114, figs. 1a, b.

*Description.*—Test in the adult with three visible chambers, sharply triangular in end view, the angles acute, surface ornamented by longitudinal raised costae; aperture oval with a simple or bifid tooth, narrow.

Length, 0.5 to 1 mm.

*Distribution.*—This species has not previously been reported from the North Pacific, the *Challenger* collecting it only in shallow water off Ceylon and shore sand from Madagascar. The only material I have had from the North Pacific is from Hongkong Harbor, where several specimens were obtained.

This is similar to *T. tricarinata* with the addition of the costate ornamentation and the difference in the apertural characters, which, in the specimens figured in the *Challenger* report, were not mature.

## TRILOCULINA INSIGNIS H. B. Brady.

Plate 27, fig. 3.

*Miliolina insignis* H. B. BRADY, Quart. Journ. Micr. Sci., vol. 21, 1881, p. 45; Rep. Voy. *Challenger*, Zoology, vol. 9, 1884, p. 165, pl. 4, figs. 8, 10.

*Description.*—Test in the adult with three visible chambers, the angles of the chambers usually rounded; test somewhat longer than wide, surface ornamented by numerous longitudinal raised costae; aperture nearly circular with a narrow bifid tooth.

Length, about 1 mm.

*Distribution.*—Brady records the species from a single North Pacific station, *Challenger* 244 in 2,900 fathoms. From the vicinity of the Hawaiian Islands I have found specimens numerous in material from *Nero* 2039 in 24 fathoms, 2040 in 21 fathoms, and 2041 in 33 fathoms.

## TRILOCULINA LINNAEANA d'Orbigny.

Plate 27, fig. 4.

*Triloculina linnaeana* D'ORBIGNY, in De la Sagra, Hist. Fis. Pol. Nat. Cuba, 1839, "Foraminifères," p. 153, pl. 9, figs. 11, 13.

*Miliolina linnaeana* H. B. BRADY, Rep. Voy. *Challenger*, Zoology, vol. 9, 1884, p. 174, pl. 6, figs. 15-20.

*Description.*—Test typically with three visible chambers in the adult, elongate, tapering toward either end, somewhat compressed, surface ornamented by a few very prominent raised ridges with deep concave depressions between; aperture rounded or slightly elliptical with a single or bifid narrow tooth.

Length, up to 2 mm.

*Distribution.*—This species is typical of tropical coral reefs in shallow water. Brady under the stations listed in the *Challenger* report gives its occurrence at one North Pacific station, 260A, in 40 fathoms from the Honolulu coral reefs, Hawaiian Islands. Bagg records it from the same islands in deeper water, *Albatross* D4174 in 735–865 fathoms, and H4568 in 1,274 fathoms. Rhumbler records it from shallow water or shore sands of Laysan Island. I have had specimens from several *Nero* stations in the vicinity of the Hawaiian Islands ranging in depth from 21 to 271 fathoms; also specimens were found in shore sand from Midway Island.

Genus ADELOSINA d'Orbigny, 1826.

*Adelosina* D'ORBIGNY (Type *A. laevigata* d'Orbigny), Ann. Sci. Nat., vol. 7, 1826, p. 303.—SCHLUMBERGER, Bull. Soc. Zool. France, vol. 11, 1886, p. 544.

*Description.*—Test in its early portion consisting of a large, laterally compressed proloculum, followed by a second chamber making a complete coil and covering the exterior of the proloculum, later chambers making a half coil, variously ornamented, most frequently with longitudinal costae.

ADELOSINA LAYSANENSIS Rhumbler.

Plate 17, fig. 9.

*Adelosina laysanensis* RHUMBLER, Zool. Jahrb., Abteil. Syst., vol. 24, 1907, p. 50, pl. 3, figs. 37, 38.

*Description.*—Test elongate elliptical, more than twice as long as broad, longitudinally ribbed, about 12 visible on the broad side of the test; apertural end slightly or not at all produced, sometimes contracted; aperture with a single tooth.

Length, 0.10 to 0.18 mm.

*Distribution.*—This species was described by Rhumbler from shore sands of Laysan, where it was found to be common.

Genus BILOCULINA d'Orbigny, 1826.

*Biloculina* D'ORBIGNY, Ann. Sci. Nat., vol. 7, 1826, p. 297 (Type *B. bulloides* d'Orbigny).—H. B. BRADY, Rep. Voy. *Challenger*, Zoology, vol. 9, 1884, p. 139.

*Description.*—Test in the adult, composed of chambers one-half coil in length, in planes 180° from one another, only the two chambers last formed visible from the exterior; aperture usually broader than long, typically with a bifid tooth.

As has already been noted in the early pages of the present part, *Biloculina* is a genus derived from *Quinqueloculina* through *Triloculina*. In the complete series of stages shown by the microspheric form of the species after the proloculum and usual second *Cornuspira*-like chamber there is built a series of chambers in planes 144° from

one another, five chambers making a cycle, therefore quinqueloculine, followed by another series added in planes  $120^\circ$  from one another, three chambers making a cycle, these in turn followed in adult *Biloculina* by chambers in two planes  $180^\circ$  apart and two chambers making the whole cycle. This, then, is the full life history in the complete series shown in the microspheric form (1) proloculum, (2) *Cornuspira*-like chamber, (3) a series of quinqueloculine chambers, (4) a series of triloculine chambers, and in the adult (5) a series of biloculine chambers.

As the adult conditions are arrived at early in the megalospheric form, and as that is much the more common in usual bottom samples, the early stages of the microspheric form, which in the young might be confused with species of *Quinqueloculina* or *Triloculina*, are relatively rare. (See pl. 27, fig. 1.)

From the standpoint of phylogenetic work it is interesting to note that the early quinqueloculine stage has an elongate aperture with a simple tooth like typical *Quinqueloculina*, the later triloculine stage a bifid tooth like typical *Triloculina*, and the adult develops the typical broad aperture and complex tooth of the genus *Biloculina*.

#### BILOCULINA DEPRESSA d'Orbigny.

Plate 28, figs. 1, 2.

*Biloculina depressa* D'ORBIGNY, Ann. Sci. Nat., vol. 7, 1826, p. 298, No. 7; Modèles, No. 91.—H. B. BRADY, Rep. Voy. *Challenger*, Zoology, vol. 9, 1884, p. 145, pl. 2, figs. 12, 16, 17; pl. 3, figs. 1, 2.—Goës, Bull. Mus. Comp. Zoöl., vol. 29, 1896, p. 87.—BAGG, Proc. U. S. Nat. Mus., vol. 34, 1908, p. 117.

*Description*.—Test in front view nearly circular, compressed, toward the periphery extending out into a thin carina, median portion rotund, in end view ellipsoid, the edges angled and drawn out into the carina; wall smooth, dull white; aperture broad, without a neck, the tooth at the ventral side wide, extending nearly the whole width of the aperture and in end view nearly filling the opening, leaving the actual aperture but a narrow slit-like opening; at the opposite end of the chamber there is often a slight fold formed by the covering over of the tooth of the previous aperture.

Diameter, specimens occur which have a diameter of 1.5 mm.

*Distribution*.—This is much the most common species of the genus in the North Pacific material that I have examined. It is one of the species more or less characteristic of *Globigerina*-ooze. The species has been recorded at numerous North Pacific stations by Brady, Goës, Picaglia, and Bagg. These stations range in depth from 104 to 3,125 fathoms, only two of them, however, being less than 500 fathoms in depth.

In the *Albatross*, *Nero*, and *Tuscarora* material it has occurred frequently, between the Hawaiian Islands and the coast of the United



States, westward along the path of the *Nero* and along the line between Guam and Japan. These stations range in depth from 665 to 2,391 fathoms, the majority of them being about 1,500 fathoms.

**BILOCULINA MURRHYNNA** Schwager.

Plate 28, fig. 3; plate 29, fig. 1.

*Biloculina murrhyna* SCHWAGER, *Novara-Exped.*, Geol. Thiel., vol. 2, 1866, p. 203, pl. 4, figs. 15 *a-c.*—SCHLUMBERGER, *Mém. Soc. Zool. France*, vol. 4, 1891, p. 165, pl. 9, figs. 52–54, text figs. 8, 9.

*Biloculina depressa* D'ORBIGNY, var. *murrhyna* H. B. BRADY, *Rep. Voy. Challenger*, Zoology, vol. 9, 1884, p. 146, pl. 2, figs. 10, 11.—BAGG, *Proc. U. S. Nat. Mus.*, vol. 34, 1908, p. 117.

*Description.*—Test in front view in young specimens nearly circular, in adult specimens somewhat longer than broad, in end view ellipsoid with the borders extended and carinate, the carina interrupted at the point opposite the aperture, leaving a sinus, rather deep and often with a long spine at each angle in young specimens; in adults sinus less deep and the spines usually reduced or wanting; aperture in the young with a neck not exceeding the periphery of the test; in adults with a prominently exerted tubular neck with a bifid tooth partially filling the nearly circular opening; wall smooth.

Diameter, usually about 1 to 1.5 mm. in adults.

*Distribution.*—Brady records a single North Pacific station for this species, *Challenger* 244 in 1,850 fathoms; Goës records it off the western coast of America in 1,000–1,200 fathoms; and Bagg from two *Albatross* stations off the Hawaiian Islands H4502 in 1,342 fathoms and H4555 in 1,398 fathoms. I have notes of its occurrence at about 20 *Nero* stations from the Hawaiian Islands westward to Midway Island, to Guam, and to Japan, most of the stations having depths of more than a thousand fathoms. It has occurred at *Albatross* D2806 in 1,379 fathoms off the Galapagos Islands and D4957 in 437 fathoms off Japan, as well as at a few scattered stations dredged by the *Tuscarora*.

**BILOCULINA SERRATA** L. W. Bailey.

Plate 29, fig. 2.

*Biloculina serrata* L. W. BAILEY, *Boston Journ. Nat. Hist.*, vol. 7, 1862, p. 350, pl. 8, fig. E.—SCHLUMBERGER, *Feuille Jeun. Nat.*, vol. 13, 1883, p. 106, pl. 3, fig. 3; *Mem. Soc. Zool. France*, vol. 4, 1891, p. 163, pl. 9, figs. 50, 51, text figs. 6, 7.

*Biloculina depressa* D'ORBIGNY, var. *serrata* H. B. BRADY, *Rep. Voy. Challenger*, Zoology, vol. 9, 1884, p. 146, pl. 2, fig. 3.—GOËS, *Bull. Mus. Comp. Zoöl.*, vol. 29, 1896, p. 87.—FLINT, *Ann. Rep. U. S. Nat. Mus.*, 1897 (1899), p. 294, pl. 40, fig. 2.

*Description.*—Test in front view nearly circular, central portion tumid, toward the periphery compressed, forming a carina which is deeply serrate, the middle of the margin opposite the aperture with a

deep reentrant, serrations less deep toward the apertural end; wall smooth, white, somewhat shining; aperture subcircular, with a narrow neck, although not produced, tooth strongly bifid, only partially filling the opening.

Diameter, up to 2 mm.

*Distribution*.—Goës recorded this species from *Albatross* material from the west coast of America in 1,000 to 1,200 fathoms. Flint also recorded it from *Albatross* D2805 in 51 fathoms in Panama Bay. I have had well-developed material from but two North Pacific stations, *Tuscarora* 47, latitude  $26^{\circ} 41' N.$ ; longitude  $142^{\circ} 42' E.$  in 1,331 fathoms, and *Albatross* D4953 in 1,350 fathoms, off Japan.

This species is evidently rare in the North Pacific. It is closely allied to *B. murrhyna*, with the deep reentrant at the basal end and in the narrow neck and nearly circular aperture.

The original description of L. W. Bailey has evidently been overlooked, as the paper was largely devoted to diatoms. An examination of the figure and description, however, are perfectly convincing evidence that this is the same species as the one that Bailey had.

An examination of the original notes and drawings of J. W. Bailey shows that he had recognized but not published this species at a much earlier date.

#### BILOCULINA SARSII Schlumberger.

Plate 30, fig. 2.

*Biloculina ringens* H. B. BRADY (not *B. ringens* Lamarck), Rep. Voy. *Challenger*, Zoology, vol. 9, 1884, p. 142, pl. 2, fig. 7.

*Biloculina sarsi* SCHLUMBERGER, Mém. Soc. Zool. France, vol. 4, 1881, p. 166, pl. 9, figs. 55-59, text figs. 10-11.

*Description*.—Test in front view nearly circular, the ends slightly truncate, in end view ellipsoid, the periphery angled, somewhat produced, margin subcarinate; wall smooth; aperture very broad in end view, with the tooth curved, concave in the middle, the ends extended and the aperture curving in a circle about them, aperture nearly two-fifths the width of the whole test.

Diameter, about 1 to 1.3 mm.

*Distribution*.—Specimens seemingly identical with this species were obtained from three *Nero* stations 1254 in 264 fathoms, between Guam and Japan, and 2037 and 2070 in 55 and 285 fathoms, respectively, both off the Hawaiian Islands. It occurred at *Tuscarora* station 47, in 1,499 fathoms, latitude  $24^{\circ} 20' N.$ , longitude  $54^{\circ} 06' E.$ , and from *Albatross* H4882 in 248 fathoms in Colnett Strait, D4807 in 44 fathoms, D4874 in 66 fathoms, and D4922 in 60 fathoms, all off Japan.

## BILOCULINA VESPERTILIO Schlumberger.

Plate 30, fig. 1.

*Biloculina ringens* H. B. BRADY (not Lamarck), Rep. Voy. *Challenger*, Zoology, vol. 9, 1884, p. 142, pl. 2, fig. 8.

*Biloculina vespertilio* SCHLUMBERGER, Mém. Soc. Zool. France, vol. 4, 1891, p. 174, pl. 10, figs. 74-76, text figs. 20-22.

*Description*.—Test in front view subcircular, the apertural end broadly truncate, in end view very tumid; the periphery rounded,

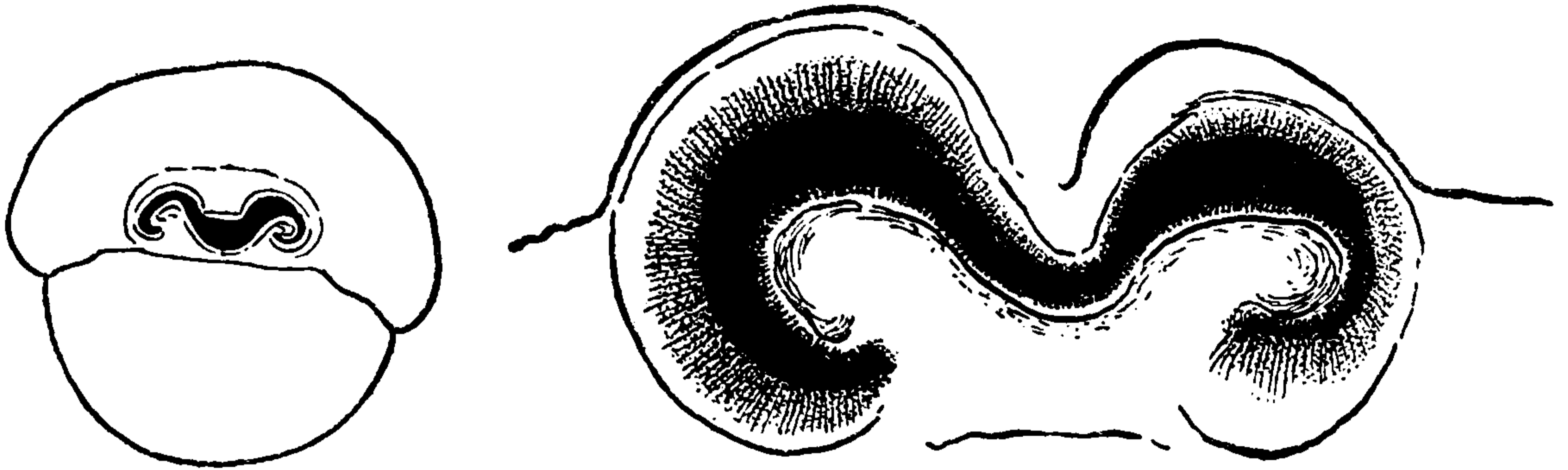

FIG. 37.—BILOCULINA VESPERTILIO SCHLUMBERGER.  $\times 5$ . OUTLINE FIGURE OF VERY LARGE SPECIMEN FROM "ALBATROSS" D5056 IN SURUGA GULF, JAPAN.

FIG. 38.—BILOCULINA VESPERTILIO SCHLUMBERGER.  $\times 50$ . APERTURAL PORTION OF TEST IN SMALLER SPECIMEN WITH THE MORE TYPICAL SINUOUS FORM OF APERTURE AND TOOTH WITH LARGE LATERAL WINGS. FROM D5056.

wall smooth except for small transverse ridges on the adult chambers; suture slightly indentate along the edges; aperture elongate, with a large tooth, the center with a slight point, the ends broadly rounded, the apertural opening narrow, curving about it.

Diameter, nearly 2 mm.



FIG. 39.—BILOCULINA VESPERTILIO SCHLUMBERGER.  $\times 50$ . APERTURAL PORTION OF TEST IN VERY LARGE SPECIMEN WHERE APERTURE HAS BECOME STRAIGHTER AND THE TOOTH LESS CONSPICUOUS. FROM D5056.

*Distribution*.—Specimens which were very similar to those described and figured by Schlumberger and by Brady were found in some numbers at *Albatross* station D5056 in 258 fathoms off the coast of Japan.

The apertural characters are very striking, having a rather beautiful series of curves.

## BILOCULINA ELONGATA d'Orbigny.

Plate 31, fig. 1.

*Biloculina elongata* D'ORBIGNY, Ann. Sci. Nat., vol. 7, 1826, p. 298, No. 4.—H. B. BRADY, Rep. Voy. *Challenger*, Zoology, vol. 9, 1884, p. 144, pl. 2, fig. 9.—

SCHLUMBERGER, Mém. Soc. Zool. France, vol. 4, 1891, p. 184, pl. 11, figs. 87, 88, pl. 12, fig. 89, text figs. 35, 36.—BAGG, Proc. U. S. Nat. Mus., vol. 34, 1908, p. 118.

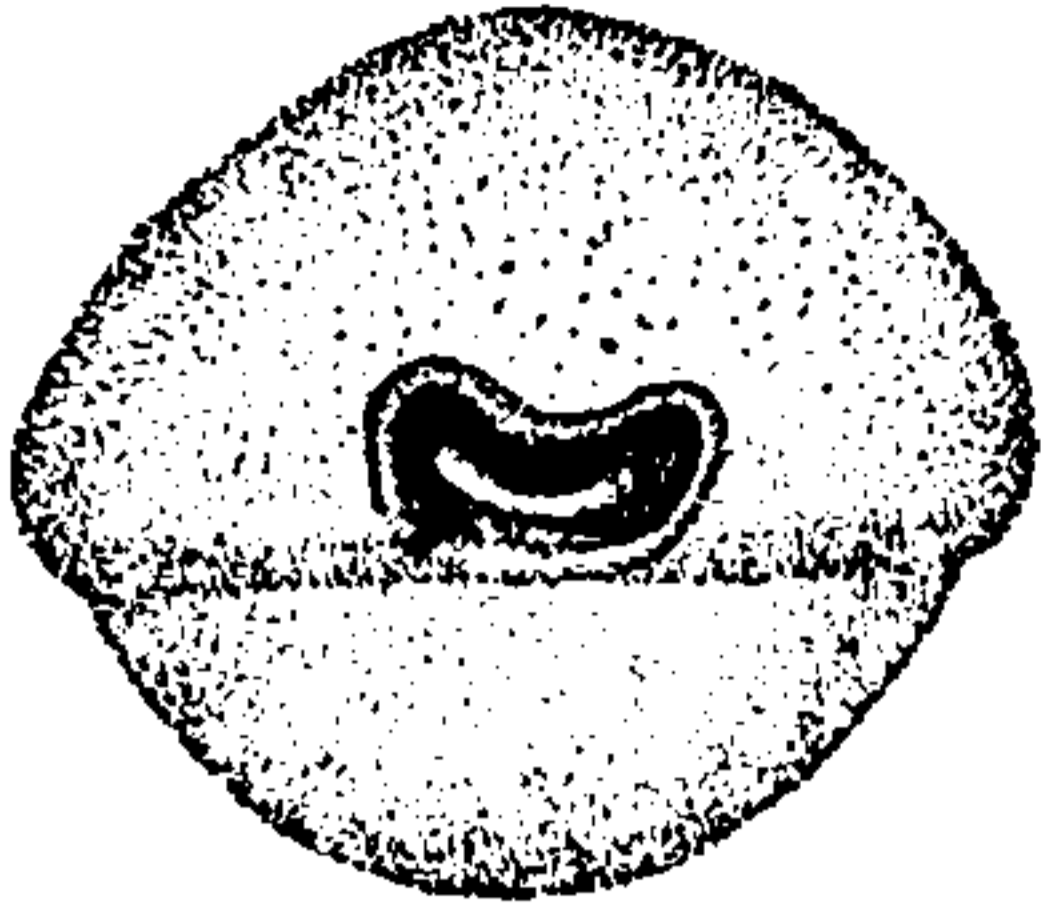

*Description*.—Test elongate, pyriform, tapering gradually to the apertural end, somewhat rounded truncate at the opposite end, in end view chambers well rounded, periphery rounded, suture depressed; wall smooth, white; aperture elliptical, about twice as long as high, with a small flattened rounded tooth only about one-fourth filling the opening in end view.

Length, 0.5 to 0.8 mm.

*Distribution*.—Bagg records this species from the following three *Albatross* stations in the vicinity of the Hawaiian Islands: D4017 in 305 fathoms, D4025 in 275–368 fathoms, and H4567 in 1,307 fathoms. I have had material from three *Nero* stations in the same region, 2037 in 55 fathoms, 2070 in 285 fathoms, and 2071 in 271 fathoms; also from *Tuscarora* station 1 in latitude

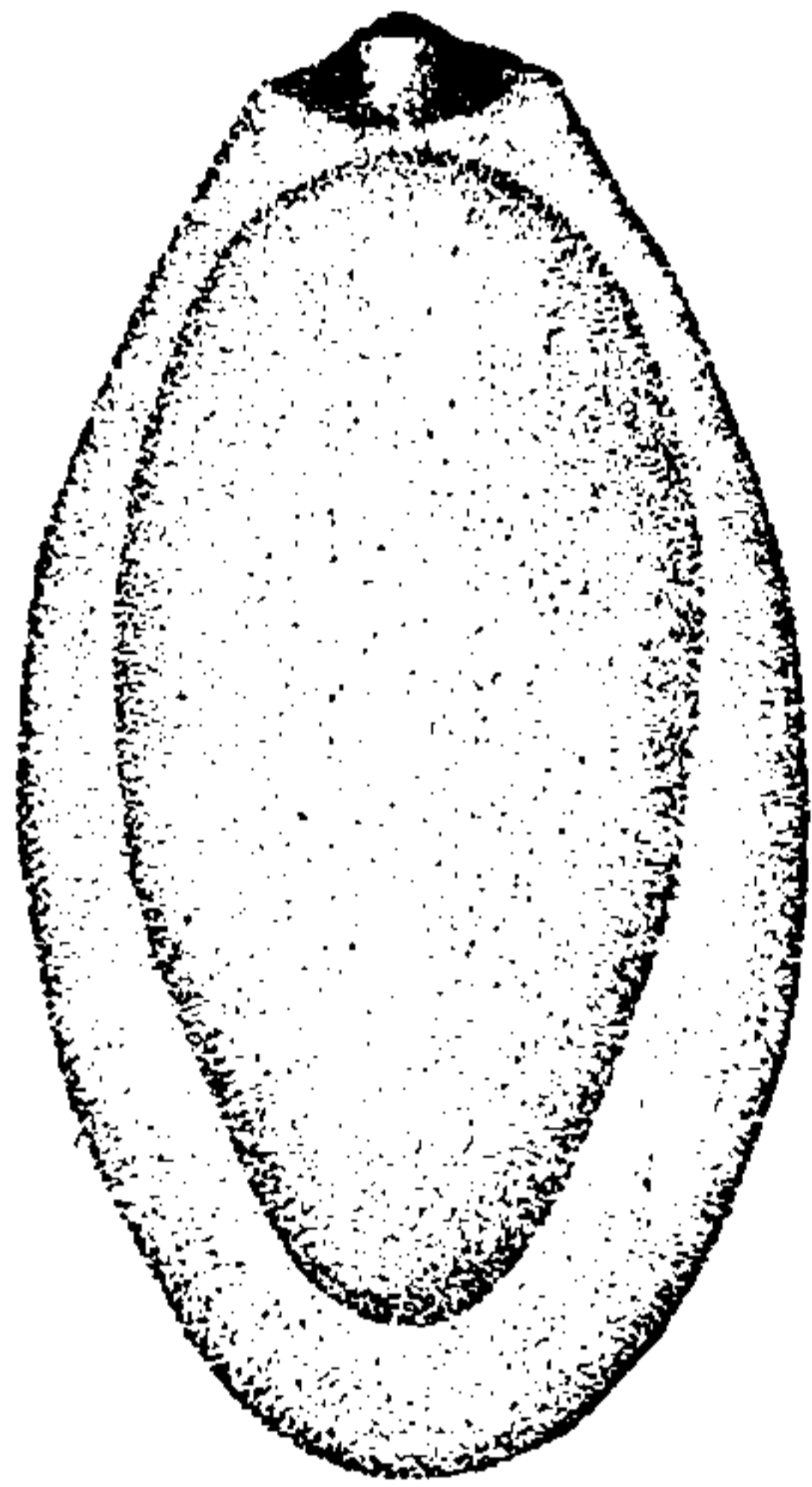

FIG. 40.—BILOCULINA ELONGATA D'ORBIGNY.  $\times 18$ .

$21^{\circ} 10' N.$ ; longitude  $158^{\circ} 04' W.$ , in 206 fathoms.

## BILOCULINA GLOBULUS Bornemann.

Plate 31, fig. 2.

*Biloculina globulus* BORNEMANN, Zeitschr. deutsch. geol. Gesell., vol. 7, 1855,

p. 349, pl. 19, fig. 3.—SCHLUMBERGER, Mém. Soc. Zool. France, vol. 4, 1891,

p. 188, pl. 12, figs. 97–100, text figs. 42–44.

*Description*.—Test in front view oval, in end view irregularly globular, chambers very tumid, suture slightly depressed, in side view the last formed chamber at the aboral end somewhat curving out over the preceding chamber; wall smooth, white; aperture semicircular, with a simple flat tooth filling a large part of the opening.

Length, about 1 mm.

*Distribution*.—About the Hawaiian Islands the species has occurred at *Nero* stations 2037 in 55 fathoms, 2071 in 271 fathoms, and *Albatross* H3007 in 323 fathoms; near Guam, *Nero* 1464 in 891 fathoms; in Colnett Strait, *Albatross* H4882 in 248 fathoms. It also occurred at two *Tuscarora* stations 1, latitude  $21^{\circ} 10' N.$ ; longitude  $158^{\circ} 04' W.$ , in 206 fathoms, and 2 in latitude  $33^{\circ} 46' N.$ ; longitude  $140^{\circ} 21' E.$ , in 437 fathoms.

## BILOCULINA ANOMALA Schlumberger.

Plate 32, fig. 1.

*Biloculina anomala* SCHLUMBERGER, Mém. Soc. Zool. France, vol. 4, 1891, p. 182, pl. 11, figs. 84-86; pl. 12, fig. 101, text figs. 32-34.

*Description.*—Test pyriform in front view, broadest near the aboral end, tapering toward the apertural end, the chambers in end view well rounded; the suture depressed, periphery of the test broadly rounded; wall smooth, white; aperture arcuate, fairly broad, in front view the dorsal edge of the aperture making an obtuse angle, which in end view shows as a slight projection into the curved line of the aperture; tooth elongate with curved ends.

Length, about 1 mm.

*Distribution.*—I have had this species from but two North Pacific stations, *Albatross* H2923 in 392 fathoms and *Nero* 2070 in 285 fathoms, both in the vicinity of the Hawaiian Islands. These specimens had all the external characters of the species. Especially distinct was the angle mentioned by Schlumberger as a characteristic feature of the species. Material was not in sufficient quantity, however, to section.

## BILOCULINA LUCERNULA Schwager.

Plate 32, fig. 2.

*Biloculina lucernula* SCHWAGER, *Novara-Exped.*, Geol. Theil., vol. 2, 1866, p. 202, pl. 4, figs. 14a-c, 17 a, b.—SCHLUMBERGER, Mém. Soc. Zool. France, vol. 4, 1891, p. 185, pl. 12, figs. 90-96, text figs. 37-41.

*Biloculina bulloides* H. B. BRADY (not d'Orbigny) Rep. Voy. *Challenger*, Zoology, vol. 9, 1884, p. 142, pl. 2, figs. 5, 6.—BAGG, Proc. U. S. Nat. Mus., vol. 34, 1908, p. 117.

*Biloculina tubulosa* H. B. BRADY (not Costa), Rep. Voy. *Challenger*, Zoology, vol. 9, 1884, p. 147, pl. 3, figs. 6, 14.—GOËS, Bull. Mus. Comp. Zoöl., vol. 29, 1896, p. 86.—FLINT, Ann. Rep. U. S. Nat. Mus., 1897 (1899), p. 293, pl. 34, fig. 1.

*Description.*—Test of adult in front view nearly circular, the apertural and aboral ends projecting somewhat; in end view the chambers well curved; the periphery bluntly angled, wall slightly roughened by the fine layer of sand which seems to be characteristic of the species, often giving it a yellowish brown appearance; aperture exserted, with a short cylindrical neck, truncate at the end, in end view circular, the small tooth well rounded, about half filling the opening.

Length, up to 1.5 mm.

*Distribution.*—Goës has recorded this species from *Albatross* D3375, in 772 fathoms off the western coast of America under the name *B. tubulosa*, and Flint from D3080 in 93 fathoms off the coast of Oregon. Bagg records it as *B. bulloides* from four *Albatross* stations off the Hawaiian Islands, D4000 in 104-213 fathoms, D4025 in 275-368 fathoms, H4555 in 1,398 fathoms, and H4596 in 367 fathoms.

The only well-characterized adult material I have had is from *Nero* station 1012 in 1,932 fathoms, between Guam and Japan, and *Nero* 1466 in 234 fathoms off Guam.

In many of the specimens of this species as shown by Schlumberger, the adult does not reach the complete biloculine development, but still retains a modified triloculine condition even in its last whorl. Such conditions are seen in many of the specimens recorded as *B. tubulosa*. The fine sand layer incorporated into the outer wall is a very striking characteristic of the species.

**BILOCULINA DENTICULATA (H. B. Brady).**

Plate 33, fig. 1.

*Biloculina ringens* (LAMARCK), var. *denticulata* H. B. BRADY, Rep. Voy. *Challenger*, Zoology, vol. 9, 1884, p. 143, pl. 3, figs. 4, 5.

*Description*.—Test roughly quadrangular in front view; in end view compressed, biconvex; apertural end broadly rounded; opposite end with a series of short irregular teeth; wall smooth; aperture very broad and narrow, extending nearly the whole width of the test, the ends somewhat expanded, tooth long and narrow, making the inner border of the aperture plate-like, somewhat raised above the level of the surface to which it is attached, as is the whole border of the aperture.

Length, up to 0.90 mm.

*Distribution*.—The typical material of this variety came from Honolulu coral reefs, Hawaiian Islands, in 40 fathoms; off Tongatabu, Friendly Islands, in 18 fathoms, and off the Admiralty Islands, in 15 to 20 fathoms. Millett records it from the Malay region. It seems, therefore, in its typical form to be an East Indian species and its relation to the Eocene *B. ringens* only remote.

The best material I have had is from shallow water in Apra Bay, Guam.

**BILOCULINA DENTICULATA (H. B. Brady), var. STRIOLATA (H. B. Brady).**

Plate 33, figs. 2, 3.

*Biloculina ringens* (LAMARCK), var. *striolata* H. B. BRADY, Rep. Voy. *Challenger*, Zoology, vol. 9, 1884, p. 143, pl. 3, figs. 7, 8.—MILLETT, Journ. Roy. Micr. Soc., 1898, p. 262, pl. 5, fig. 8.

*Description*.—General form similar to the typical *B. denticulata*, but with the added character of a definite surface ornamentation consisting of a series of costae on the lower half of the penultimate chamber, occasionally on the ultimate also.

Length, up to 0.85 mm.

*Distribution*.—Brady described this variety from a few stations among the islands off the southern shores of New Guinea, just west

of Torres Straits, in 6 to 8 fathoms. Millett records it at one station in the Malay region, Barvean Roads, between Java and Borneo, in 14 fathoms. The only material I have had that figured here is from *Nero* station 2071, in 271 fathoms, off the Hawaiian Islands.

This record links closely the distribution of this variety with the typical form of the species.

**BILOCULINA COMATA H. B. Brady.**

Plate 34, fig. 1.

*Biloculina comata* H. B. BRADY, Quart. Journ. Micr. Sci., vol. 21, 1881, p. 45; Rep. Voy. *Challenger*, Zoology, vol. 9, 1884, p. 144, pl. 3, figs. 9a, b.

*Description.*—Test subglobular, the chambers very much inflated and rotund, in end view subcircular, wall ornamented with numerous fine longitudinal costae; aperture elongate, with a tooth with large wing-like developments at the ends.

Length, up to 2.5 mm.

*Distribution.*—From most of the records for this species it seems to be widely distributed at medium depths. In the North Pacific material I have examined it has occurred at the following stations: about the Hawaiian Islands, *Albatross* station H2922, in 268 fathoms; H3007 in 323 fathoms; *Nero* 200 in 625 fathoms; 366 in 1,511 fathoms and 1692 in 754 fathoms between Midway Island and Guam; 1410 in 1,444 fathoms between Guam and Japan.

**BILOCULINA COMATA H. B. Brady, var. SERRATULA, new variety.**

Plate 34, figs. 2, 3.

*Description.*—Test in general similar to *B. comata*, the ornamentation much closer and finer and less evenly distributed, the test being a striated one rather than a test with costae as in the typical form; the periphery with a few very prominent tooth-like projections; apertural end contracted into a short neck; aperture itself nearly circular with a small bifid tooth.

Length, up to 2 mm.

*Distribution.*—Type-specimen (Cat. No. 9164, U.S.N.M.) from *Nero* station 1299 in 1,817 fathoms; others from *Nero* station 1294 in 1,417 fathoms and 1311 in 1,503 fathoms, all between Japan and Guam.

Added data may show that this is a definite species rather than a variety of *B. comata*, as it has a considerable number of distinctive characters. More material, however, is desirable.

**BILOCULINA MILLETTII, new species.**

Plate 34, figs. 4, 5.

*Miliolina durrandi* MILLETT (part) Journ. Roy. Micr. Soc., 1898, p. 268, pl. 6, figs. 8–10 (not fig. 7).

*Description.*—Test in front view broadly elliptical, in end view compressed, chambers biconvex, the periphery with a definitively developed thin carina, wall smooth except for occasional transverse ribs usually indistinct; aperture slightly produced, broadly elliptical, with a slightly thickened border joining the carina at its outer edge; the aperture with a small bifid tooth.

Length, up to 1 mm.

*Distribution.*—Millett's material was from the Malay region. The specimens here figured (type Cat. No. 9165, U.S.N.M.) are from Hongkong Harbor.

In his figures Millett apparently has two distinct species, one a *Quinqueloculina* or *Massalina* with a conspicuous surface ornamentation of oblique costae near the peripheral border of the apertural end of the chambers, the other a smooth *Biloculina*. All the figures are of equal or greater magnification than figure 7, so that is apparently not the young of the form shown in the other figures, 8 to 70.

**BILOCULINA SEMICOSTATA, new species.**

Plate 34, fig. 6.

*Description.*—Test in front view subcircular, in end view somewhat compressed, biconvex; wall smooth except for the definite costae of the ornamentation running from the aperture as a single median longitudinal costa, soon becoming dichotomously divided into two, which run slightly beyond the median point of the test, where they gradually disappear; penultimate chamber with similar costae; apertural end somewhat produced and contracted to form a sub-cylindrical neck with a slightly thickened lip and broadly elliptical aperture with a rounded tooth filling a large part of the aperture.

Length, about 1 mm.

*Distribution.*—Type-specimen (Cat. No. 9166, U.S.N.M.) from *Nero* station 372 in 1,738 fathoms between Midway Island and Guam.

The definite single median costae, becoming divided into two in the central portion of the surface of the chamber, is the most striking feature of this apparently deep-water species.

**BILOCULINA FLINTII, new species.**

Plate 35, fig. 1.

*Description.*—Test spinose, the periphery with a series of irregular spinose projections and a stout spine in the middle of the surface of each chamber; wall otherwise smooth, apertural end contracted and extended into a short conical neck with a circular aperture and a bifid tooth.

Length, up to 1.35 mm.

*Distribution.*—Type-specimen (Cat. No. 9167, U.S.N.M.) from a *Nero* station near Midway Island, but without number. Other speci-



mens are from *Nero* station 461 in 711 fathoms and 1692 in 754 fathoms between Midway Island and Guam.

This is a rather striking species with its large spines and projecting neck. It is named after Dr. James M. Flint, of the United States National Museum.

Genus NEVILLINA Sidebottom, 1905.

*Nevillina* SIDEBOTTOM (Type *N. coronata* (Millett)), Mem. and Proc. Manchester Lit. and Philos. Soc., vol. 49, pt. 2, No. 11, 1905, p. 1.

*Description.*—“Test free, elongate, more or less pyriform, circular in transverse section, the final chamber completely embracing the previous one. Aperture circular, complex, formed by numerous incurved lamellae, meeting centrally.”

The above is the original description of the genus as given by Sidebottom. The early stages are shown in his figures to be triloculine before the final single chambered condition is taken on. Evidently this is a genus which is developed from *Biloculina* and is found in a region containing older types such as *Trigonia* and *Nautilus*. Comparing the fossil foraminifera, the relationships of this most interesting form are rather clearly indicated.

Munier-Chalmas and Schlumberger have described two genera, *Idalina* and *Periloculina*, from the Upper Cretaceous of southern Europe, which are very clearly related to this genus *Nevillina*. In both *Idalina* and *Periloculina* the same character of a completely embracing chamber is found in the adult and the aperture is also complex, in both having a large area with many openings radiating toward the center. In *Idalina* especially is found a circular aperture with numerous roughly triangular openings with the base at the periphery and apex toward the center, rather more ornate and complex than in *Nevillina*, but essentially the same.

The development of both *Idalina* and *Periloculina* has been worked out by Munier-Chalmas and Schlumberger in great detail.

In the development of *Idalina*, at least in the microspheric form, after a *Cornuspira* stage following the proloculum, there is developed the regular quinqueloculine test with a 2/5 arrangement of the chambers—that is, each succeeding chamber placed at a point 144° from the preceding one, five chambers being necessary to make up the periphery. This in turn is followed by a regular triloculine stage, in which the chambers are added 120° from one another, three chambers completing the periphery, followed in turn by a biloculine stage with chambers 180° from one another, two chambers completing the periphery. In the final adult stage the last formed chamber embraces all the others, except at the point of attachment above the previous aperture. The development of *Periloculina* shows the same series of stages in the microspheric form at least.

The very early stages in *Nevillina* are not described, but there is evidently an early triloculine stage followed by a biloculine one before the adult embracing chamber is formed. These stages are shown in Sidebottom's figures and noted by him. Microspheric specimens would undoubtedly show the complete series of developmental stages already noted for *Idalina*.

This is, then, a most interesting recent genus, allied closely with these upper cretaceous genera of southwestern Europe. It is found also in that portion of the oceans which is known to contain some of the most ancient forms in regard to certain groups of the mollusca at least.

A single species is known and it seems to be very rare.

NEVILLINA CORONATA (Millett).

Plate 35, figs. 2-5.

*Biloculina coronata* MILLETT, Journ. Roy. Micr. Soc., 1898, p. 263, pl. 6, figs. 6a-c.

*Nevillina coronata* SIDEBOTTOM, Mem. and Proc. Manchester Lit. and Philos. Soc., vol. 49, pt. 2, No. 11, 1905, p. 1, pl., figs. 1-8.

*Description.*—"Test elongate, more or less pyriform, circular in transverse section. Aperture circular, complex, formed by numerous incurved lamellae, meeting centrally."

Length, up to 2 mm.

*Distribution.*—Millett's specimen was from the northeast coast of Sumatra, while those of Sidebottom were from Port Blair, east side of Andaman Island, at entrance to the port, between Ross Island and the main island, 16 fathoms, and Sulu roadstead, 12 fathoms. The last station is followed by this note: "Very strong tide sweeping through the anchorage. Many shoals, and reefs of growing coral in the Sulu Sea, and many banks frequented by pearl fishers."

From the fact that the species does not seem to have been taken by the *Challenger* and that Millett had but a single specimen it is evident that it is a very rare species.

The description and figures are from Sidebottom.

Genus PENEROPLIS Montfort.

*Nautilus* (part) FORSKÅL, Descr. Anim., 1775, p. 125.

*Peneroplis* MONTFORT, Conch. Syst., 1808, 65th genre, p. 259.—H. B. BRADY, Rep. Voy. *Challenger*, Zoology, vol. 9, 1884, p. 203.

*Description.*—Test planospiral, at least in the early stages, whole test lenticular, thick or much compressed, circular, crosier-shaped or cylindrical; surface smooth or the chambers longitudinally striate; chambers entire, not subdivided as in the following genera; aperture in the complanate forms consisting of a linear series of pores on the apertural face, in the less compressed forms an irregularly arranged series of pores and in the more or less uncoiled forms often becoming dendritic.

There are numerous varieties or species which by recent authors have usually been placed in a single species, *P. pertusus* (Forskål). As the various forms seem to have rather constant characters of form in combination with certain characters of aperture it seems as though they may really be more distinctive than has been given general credit. The genus is especially common in shallow waters of the tropical regions, being one of the characteristic foraminifera of coral reefs.

The young of *Peneroplis pertusus* have been observed by Schacko. Copies of two of his figures are given (fig. 1). In this early development at the time that the mégalospheric young leave the parent test they consist each of a globular or oval proloculum with the encircling second chamber usually about a half coil in length, being very similar to the early stage of the Quinqueloculine series and of *Spiroloculina*. These two chambers have a thin shell wall of even thickness throughout, the wall of the second *Cornuspira*-like chamber being continuous with that of the proloculum and building no floor on the adjacent wall of the proloculum. The apertural end of the second chamber has a slightly thickened lip.

Figure 41 shows the development seen in the early chambers of the ordinary mégalospheric form, the proloculum measuring  $35\mu$  in this specimen. Here, as in the young specimen (fig. 1), there is a globose proloculum (1) followed by the elongated, coiled second chamber (2) comparable to *Cornuspira*.

In *Peneroplis* as in the two following genera (*Orbiculina* and *Orbitolites*) the first and second chambers are perforated by very fine pores. *Peneroplis* was removed from this group by Rhumbler on this basis of perforations, but it has since been shown by Lister to be equally characteristic of the early chambers of *Orbiculina* and *Orbitolites*.

The third chamber (3) is more or less globular, connecting with the second chamber by a narrow passage, circular in cross section. The floor of this chamber is laid down on the wall of the proloculum, causing an appreciable thickening. The aperture of chamber 3 is on the inner border of the apertural wall and takes an oblique direction as it traverses the wall of the test. This obliquity causes a thickening of the wall below, which is characteristic throughout the later development of the test. Succeeding chambers are very similar to chamber 3 in their general characters. This series of chambers forms a close coiled test. In the specimen figured the first eight globular chambers make up a complete coil. In succeeding coils the number of chambers in a single coil is larger, as the chambers do not increase in size proportionately to the increase in the size of the test.

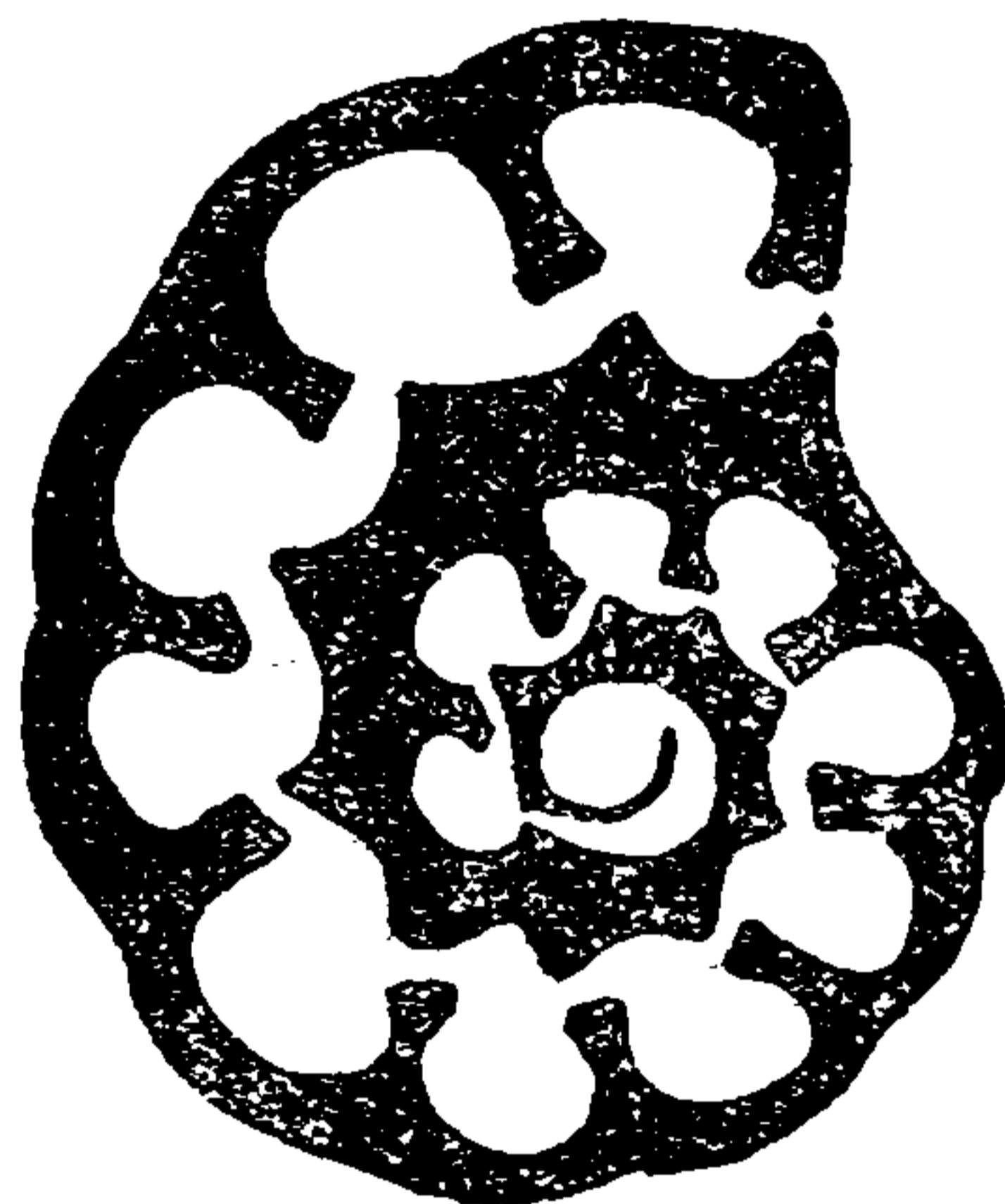

FIG. 41.—EARLY CHAMBERS OF *PENEROPLIS PERTUSUS*, VAR. *ARIETINUS*,  $\times 83$ . MEGALOSPHERIC PROLOCULUM  $35\mu$  IN DIAMETER.

All of the earlier chambers of *Peneroplis* have similar apertures but in later coils there are developed multiple apertures in some cases. Certain forms may complete their tests with all of the apertures single; others may have multiple apertures developed fairly early. This apparently has a definite relation to the form of the test.

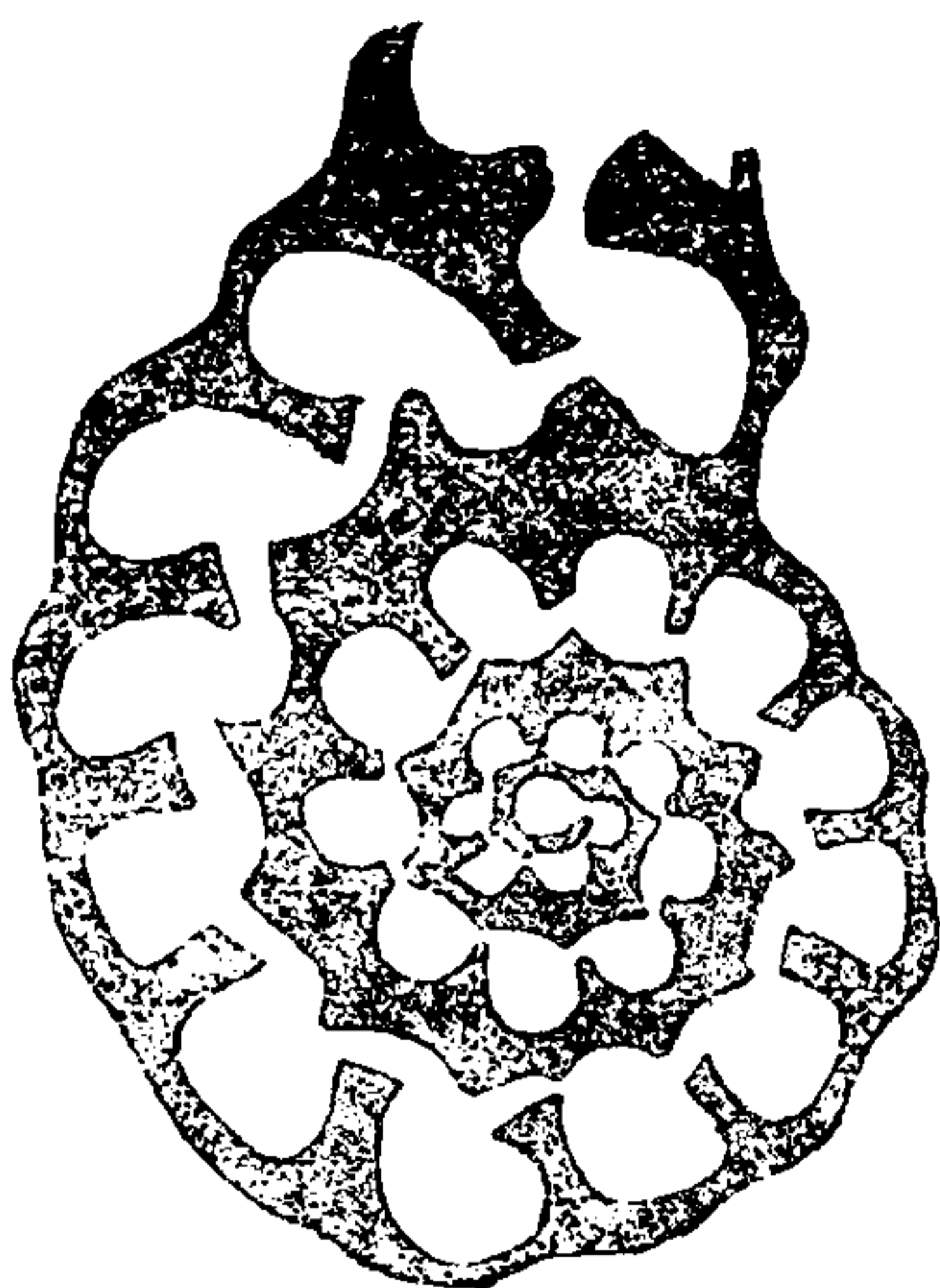

FIG. 42.—EARLY CHAMBERS OF *PENEROPLIS PERTUSUS*, VAR. *ARIETINUS*,  $\times 100$ . MICROSPHERIC PROLOCULUM  $18\mu$  IN DIAMETER.

The microspheric form of the test (fig. 42) differs from the megalospheric form in the size of the proloculum, the number of coils in the test, and especially in the loss of the *Cornuspira*-like second chamber. The same condition will be noted in the two following genera, *Orbiculina* and *Orbitolites*. This is a very peculiar condition in which the microspheric form is the more accelerated in this respect, while in most of the genera of the family it is the megalospheric form which is

the most accelerated and therefore most apt to skip certain of the early stages.

**PENEROPLIS PERTUSUS (Forskål).**

Plate 36, fig. 1; plate 37, figs. 1, 2, 6.

*Nautilus pertusus* FORSKÅL, Descr. Anim., 1775, p. 125, No. 65.

*Peneroplis pertusus* JONES, PARKER, and H. B. BRADY, Foram. Crag., 1865, p. 19.—H. B. BRADY, Rep. Voy. *Challenger*, 1884, p. 204, pl. 13, figs. 16, 17.

*Description.*—Test planospiral, composed of several coils, central umbilical portion usually visible throughout the development of the test, chambers numerous, increasing gradually in height, but the test close coiled throughout; sutures somewhat depressed, wall marked by longitudinal, slightly oblique lines; aperture consisting of numerous slightly elongate pores along the apertural face, the whole with a thickened lip.

Diameter, up to 2 mm.

*Distribution.*—Bagg records this typical form from *Albatross* station 4017 in 305 fathoms near the Hawaiian Islands and Rhumbler from shore sands of Laysan Island. In the *Nero* material the typical form has occurred at numerous stations off the Hawaiian Islands in from 22 to 271 fathoms, off Guam, *Nero* 1466 in 234 fathoms, from Manila Bay and from Gaspar Straits, North Pacific Exploring Expedition, Captain Rodgers. It also occurred at *Tuscarora* 60, latitude  $21^{\circ} 14'$  N.; longitude  $157^{\circ} 36'$  W. in 63 fathoms.

Besides this typical, planospiral, closely coiled form, there are several different forms which seem worthy of at least varietal distinction. In the material at my disposal these do not seem to have

their distinctive characters broken down as claimed by Brady, but seem to be well characterized. In their earlier stages they may not be easily distinguished, but this is also true of various allied forms in many groups.

**PENEROPLIS PERTUSUS (Forskål), var. PLANATUS (Fichtel and Moll).**

Plate 37, fig. 3.

*Nautilus (Lituus) arietinus* (part) BATSCH, Conch. Seesandes, 1791, p. 4, pl. 6, figs. 15a, b.

*Nautilus planatus*, var. B. FICHTEL and MOLL, Test. Micr., 1803, p. 91, pl. 16, figs. 1d, e, f.

*Peneroplis planatus* D'ORBIGNY, Ann. Sci. Nat., vol. 7, 1826, p. 285, No. 1; Modèles, No. 16.—H. B. BRADY, Rep. Voy. *Challenger*, Zoology, vol. 9, 1884, p. 204, pl. 13, fig. 15.

*Description*.—Test in the young close coiled, becoming in the adult broad and complanate, the chambers increasing rapidly in height, wall ornamented with numerous longitudinal costae, broken at the depressed sutures; aperture consisting of a long, single row of small circular pores along the median line of the flattened apertural face.

*Distribution*.—Bagg records this variety from *Albatross* station 4694 in 865 fathoms off the Hawaiian Islands. I have specimens from a single *Nero* station in the same region 2039 in 24 fathoms. It also occurred in the material from Gaspar Straits, from Hongkong, and from the *Tuscarora* from Manila Bay.

In some respects the young of this variety may resemble the typical form, but the height of the chambers increases fairly early and it is much flatter as well. The apertural characters of the adult are also seen fairly early in the development.

**PENEROPLIS PERTUSUS (Forskål), var. CARINATUS d'Orbigny.**

Plate 37, fig. 4.

*Peneroplis carinatus* D'ORBIGNY, Foram Amér. Mérid., 1839, p. 33, pl. 3, figs. 7, 8.—H. B. BRADY, Rep. Voy. *Challenger*, Zoology, vol. 9, 1884, p. 205, pl. 13, fig. 14.

*Description*.—Test planospiral, nautiloid, each coil completely covering the preceding to the umbilicus, test close coiled throughout, sutures usually strongly limbate; wall smooth; aperture consisting of numerous small circular pores scattered over the roughly triangular apertural face.

*Distribution*.—Specimens of this variety were found in some numbers in the material from Gaspar Straits but were not found elsewhere in the North Pacific material.

This form seems very different from most of the others and seems more worthy of specific rank than the others included here.

## PENEROPLIS PERTUSUS (Forskål), var. ARIETINUS (Batsch).

Plate 36, fig. 2; plate 37, fig. 5.

*Nautilus (Lituus) arietinus* (part) BATSCH, Conch. Seesandes, 1791, p. 4, pl. 6, fig. 15c.

*Peneroplis arietinus* PARKER, JONES, and H. B. BRADY, Ann. Mag. Nat. Hist., ser. 3, vol. 16, 1865, p. 26, pl. 1, fig. 18.—H. B. BRADY, Rep. Voy. *Challenger*, Zoology, vol. 9, 1884, p. 204, pl. 13, figs. 18, 19, 22.

*Description*.—Test planospiral in its early stages, later becoming uncoiled and building chambers in a linear series, in transverse section elongate elliptical, wall longitudinally striate, aperture consisting of an irregular series of pores in the middle line of the apertural face.

*Distribution*.—Rhumbler has recorded this variety from shore sands of Laysan Island. I have it from *Nero* stations 2039 in 24 fathoms and 2042 in 55 fathoms off the Hawaiian Islands, from Gaspar Straits, and *Tuscarora* material from Manila Bay.

## Genus ORBICULINA Lamarck, 1816.

*Nautilus* (part) FICHEL and MOLL (type, *O. adunca* (Fichtel and Moll)), Test. Micr., 1803, p. 112.

*Orbiculina* LAMARCK, Ency. Méthod., pt. 23, 1816, p. 468.—H. B. BRADY, Rep. Voy. *Challenger*, Zoology, vol. 9, 1884, p. 208.

*Description*.—Test planospiral, at least in its early stages, the chambers numerous, and in the later stages, at least, subdivided into chamberlets, the early chambers in all forms extending over the early test to the umbilical region, making a completely involute test in the early stages, later tests may continue the completely involute character, or may become annuli or build a crosier-shaped test, wall usually pitted, sometimes smooth; aperture in the adult usually consisting of a double row of small circular openings usually opposite, along the median portion of the apertural face of the test.

This genus may most easily be distinguished from *Peneroplis* by its subdivided chambers and from *Orbitolites* by the early chambers which in *Orbiculina* are involute, causing a thickening of the test in the umbilical region. From *Orbitolites duplex* it may be distinguished by the pores which in circular specimens of *Orbiculina* are near the median line of the apertural face and usually opposite, while in *Orbitolites duplex* they are near the peripheral margins and usually alternate.

*Orbiculina* is not at all common in the North Pacific, but from the records appears to be common about the East Indies and Philippines. A comparison of the development of the two most distinctive forms *O. compressa* and *O. adunca* is here given for a comparison on one hand with *Peneroplis* and on the other with *Orbitolites*.

*Development of Orbiculina compressa d'Orbigny.*

The early chambers in a specimen of this species are shown in figure 43. There is an oval proloculum with a thin wall of uniform thickness. The second chamber is elongate, closely coiling on the surface of the proloculum for about a half coil in length. Both the proloculum and this second chamber are finely perforate, a character seen also, as already noted, in the young of *Peneroplis*. The third chamber is globular and connects with chamber 2 by a single aperture. Chambers 3 to 7 are of the same general character, and at this stage (in section at least) this might be the young of *Peneroplis*. Chamber 7 completes a single coil from the proloculum. This number of chambers is also very similar to the condition seen in the first coil of *Peneroplis*. Chamber 8 adds a new character, that of multiple apertures, there being two in this chamber. Chambers 8 to 12 each have two apertures. Chamber 15 has developed three apertures.

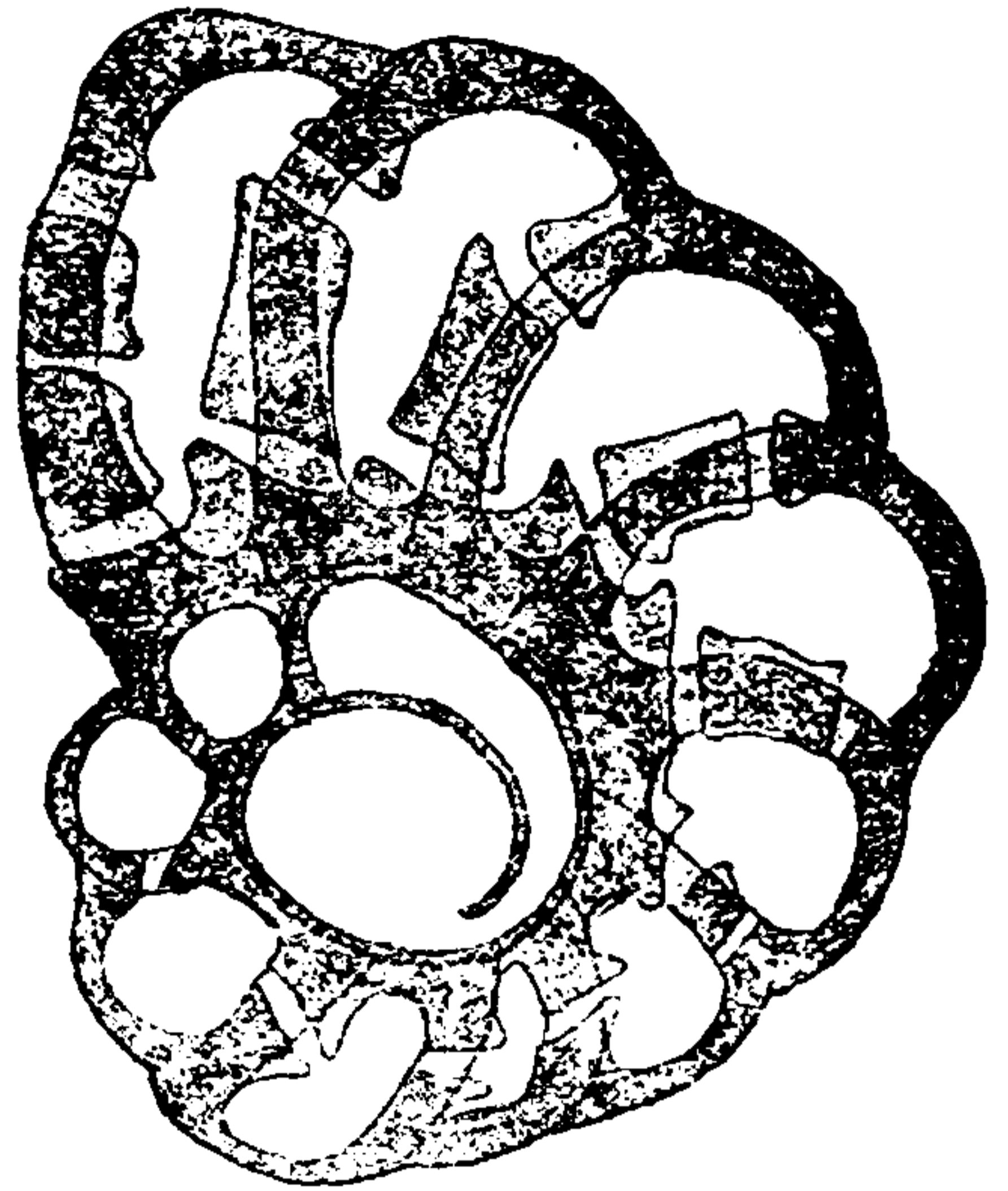

FIG. 43.—EARLY CHAMBERS OF ORBICULINA COMPRESSA D'ORBIGNY,  $\times 83$ .

As the chambers increase in height there is a corresponding increase in the number of the apertures. In the later development of this same specimen (fig. 44) the chambers increase rapidly in height from the sixteenth to the twentieth. The outer end of each chamber keeps to the outer curve of the test which has taken on a less closely coiled condition. As the opposite or inner end of each chamber extends back to the previous coil, a considerable increase in the extent of the chamber must necessarily result. Chamber 21 initiates a new character, its outer end extending beyond that of the preceding and back on the outer curve of the test. This is continued by the following chambers each extending back at both ends to the wall of the earlier built portion. This method of growth is continued until the opposite ends of a chamber meet on the peripheral wall and make a complete annulus. This takes place in this individual at the thirty-fifth chamber. From this point each chamber forms a complete annulus about the preceding chambers throughout succeeding growth.

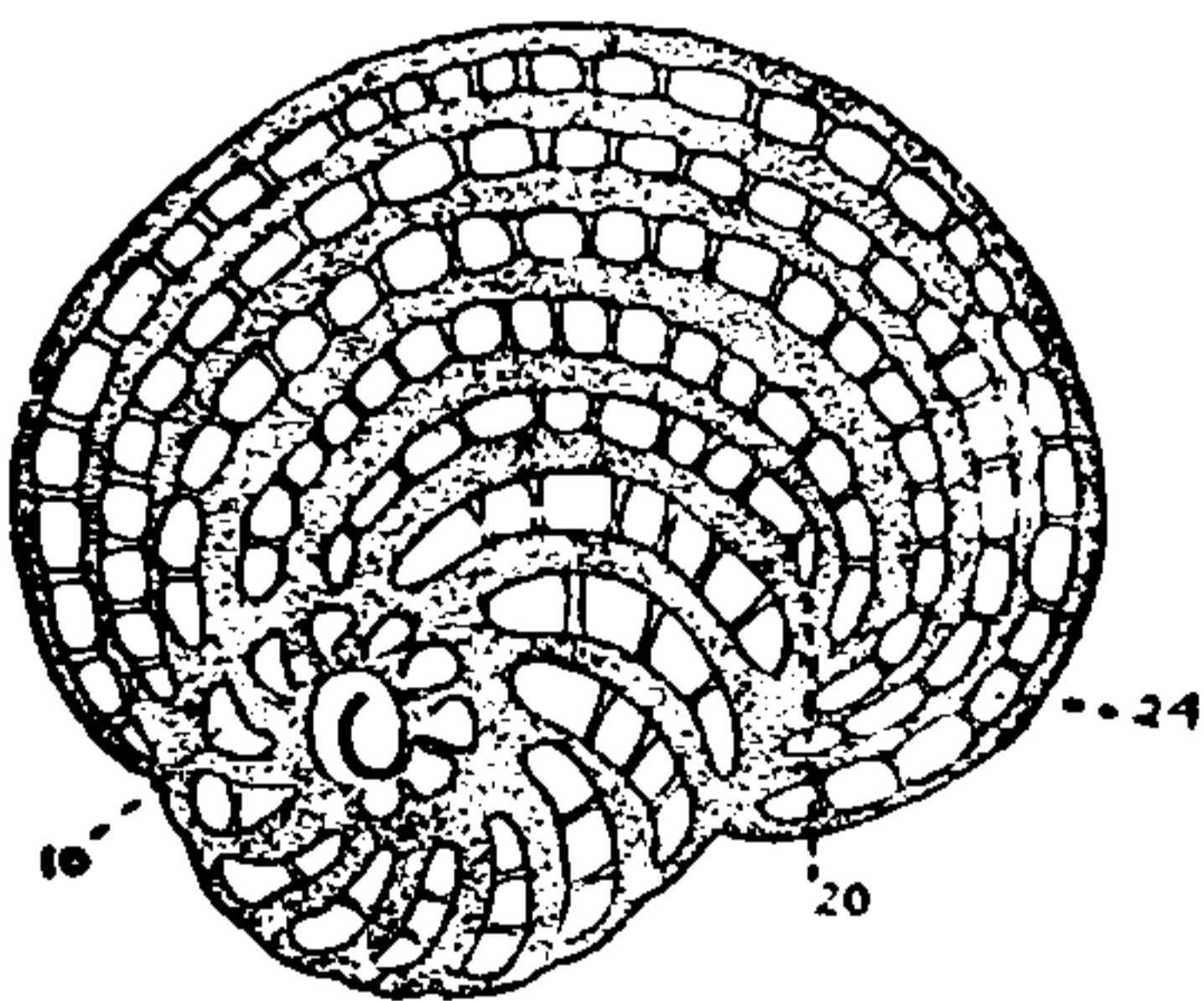

FIG. 44.—DEVELOPMENT OF A SPECIMEN OF ORBICULINA COMPRESSA D'ORBIGNY, UP TO AND INCLUDING THE TWENTY-FOURTH CHAMBER.  $\times 25$ .

*Development of Orbiculina adunca (Fichtel and Moll).*

This species in its early development is in most respects comparable to that of the preceding species, *O. compressa*, but is much more

accelerated. There is in the megalospheric form (fig. 45), a large, nearly spherical proloculum, followed by an elongated chamber of a half coil in length. This second chamber is very low at its inception but widens gradually toward its apertural end. The wall of the proloculum and second chamber is continuous, of uniform thickness,

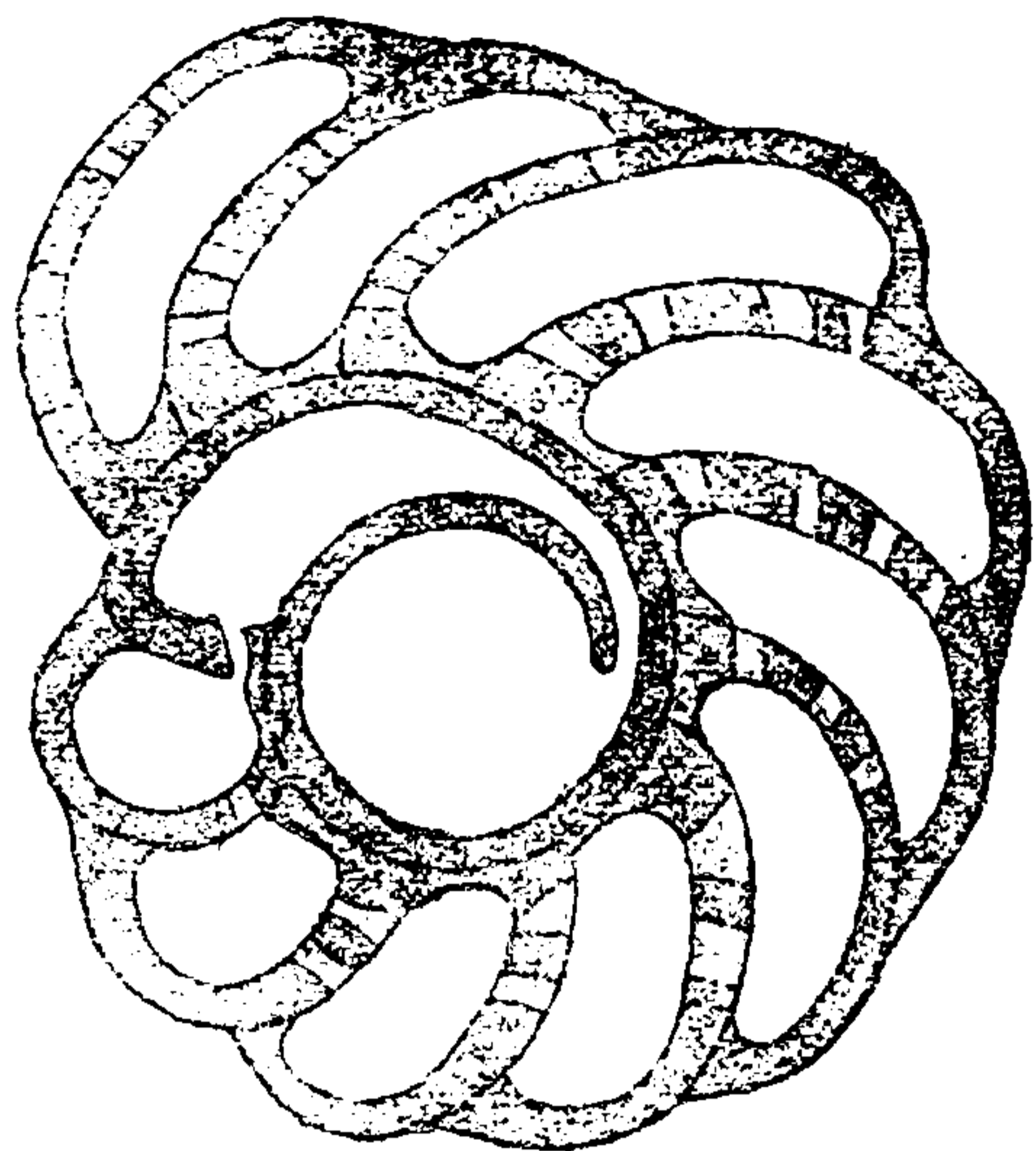

FIG. 45.—EARLY CHAMBERS OF ORBICULINA ADUNCA, BY TRANSMITTED LIGHT,  $\times 50$ .

in the second chamber building no floor, and as already noted in *Peneroplis* and *O. compressa* the wall is perforate. Chamber 3 is globular with a single aperture exactly comparable to the third chamber of *O. compressa* and also to the third chamber of *Peneroplis*. Its shell development may be seen in the figure, continuing the periphery of the test from chamber 2 and making a thin layer on the apertural wall of that chamber, building its floor directly on the wall of the proloculum. This same development may be seen in the

chambers of *O. compressa* (fig. 43).

In *O. adunca* chamber 4 has two apertures, thus taking on here the character which was taken on in the specimen of *O. compressa* in the eighth chamber and in *Peneroplis* taken on much later than this, the sixteenth chamber in Schačko's figure and in some specimens of *Peneroplis* never reached (fig. 41).

*O. adunca* is then a much accelerated species.

Chamber 5 has also two apertures. Chamber 6 has three apertures, a character not attained in the specimen of *O. compressa* until chamber 13. Chamber 7 also has three apertures. Chamber 8 has four apertures, as have the other chambers shown in the figure. Instead of the test being a compressed one as in *O. compressa*, *O. adunca* has a much thicker test due to the overlapping of the preceding chambers at the sides. This is shown in the

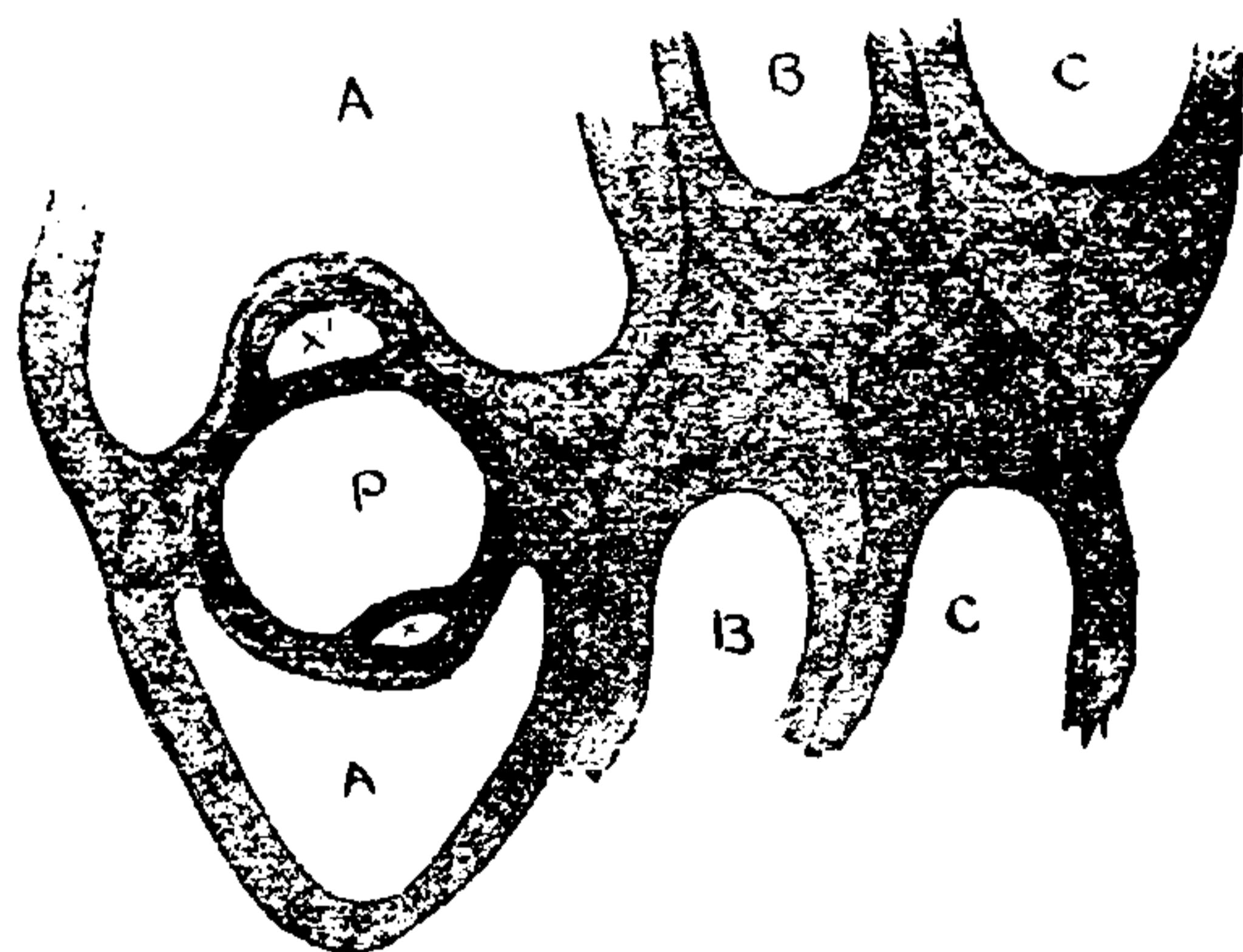

FIG. 46.—PORTION OF VERTICAL SECTION OF ORBICULINA ADUNCA,  $\times 50$ , SHOWING EARLY STAGES AND LATER INVOLUTE WHORLS IN SECTION ON RIGHT BB', CC'. P, PROLOCULUM, XX', SECOND CORNUSPIRA-LIKE CHAMBER CUT ON BOTH SIDES OF THE PROLOCULUM, A, A', CHAMBERS OF FIRST VOLUTION.

section (fig. 46) at right angles to the first section. In this figure P shows the proloculum and X and X' the two opposite portions of chamber 2 in cross section. At X the common wall between the two chambers is bent inward and at



X' it is simply flattened. This is interesting in comparison with the section of the actual two-chambered young of *Peneroplis* figured by Schako (fig. 1). where the wall of the proloculum is simply flattened on the two sides and not bent inward. Lister's figure of a similar section of *O. adunca* shows this concavity at one side and flattening at the other as in our figure. At A is shown the section across a chamber in the position of chamber 8 or 9 in the other section (fig. 45)—that is, a chamber at the point where one complete coil has been made. At A' is shown a portion of a chamber on the opposite side. These two chambers indicate in section the width of the test at the second coil. Chambers B and B' show the thickness of the test at the end of the third coil and C and C' at the completion of the fourth coil. Each coil slightly overlaps its preceding half, as is seen in the cross section. After making about four complete coils the chambers increase greatly in height in this form. This may continue until the wing-like growth thus formed swings completely about the test, but in this species the ends of a chamber do not unite with one another to form annuli, but the growth turns back onto the earlier portion of the test and at this edge the test becomes formed of two nearly parallel plates.

*O. compressa* typically forms but one and a half coils before beginning to extend back on its own periphery and very soon thereafter the opposite ends of a chamber unite and form a complete annulus. The annuli are formed throughout further growth and the size of the test increases rapidly.

The two types of development in later stages are very different, that of *O. compressa*, the simpler, more nearly like *Peneroplis* and leading directly toward *Orbitolites*, especially the simplest species *O. marginalis* which it resembles in many respects. The later development of *O. adunca*, however, is more complex and tends in certain respects toward the genus *Alveolina*.

#### ORBICULINA ADUNCA (Fichtel and Moll).

Plate 37, figs. 7, 8.

*Nautilus aduncus* FICHEL and MOLL, Test. Micr., 1803, p. 115, pl. 23.

*Orbiculina adunca* LAMARCK, Tabl. Encycl. et Meth., 1816, pl. 468, figs. 2a-c.—D'ORBIGNY, in De la Saga, Hist. Fis. Pol. Nat. Cuba (Foraminifères) 1839, p. 81, pl. 8, figs. 8-14.—H. B. BRADY, Rep. Voy. *Challenger*, Zoology, vol. 9, 1884, p. 209, pl. 14, figs. 1-13.

*Description*.—Test typically planospiral, involute, each coil completely covering the previous one; chambers increasing rapidly in height, much curved; sutures distinct, but slightly depressed; wall smooth or slightly pitted; aperture consisting of usually a double series of small rounded pores, each with a slight raised border, on the apertural face of the test, which is flattened or slightly depressed.

*Distribution.*—Brady records this species from the North Pacific only from among the Philippines. The only material I have from this region is collected by the *Tuscarora* in Honduras Bay.

Brady records the species from about various East Indian Islands, and it is interesting to note that in the *Challenger* material it is not given from the Honolulu Reefs. Bagg records it from two *Albatross* stations but an examination of his material from both these stations shows that the specimens are *Orbitolites marginalis* and not *Orbiculina*. They resemble the flattened compressed *Orbiculina compressa*, but the central portion is not involute, the early chambers being all visible as in typical *Orbitolites marginalis*. I have failed to find *Orbiculina* in the Hawaiian region, although I have had but a small amount of shallow water material.

#### Genus ORBITOLITES Lamarck, 1801.

*Orbitolites* LAMARCK, Syst. Anim. sans Vert., 1801, p. 376 (Type *O. complanata* Lamarck).—H. B. BRADY, Rep. Voy. *Challenger*, Zoology, vol. 9, 1884, p. 210.

*Description.*—Test typically discoidal, the early chambers, in the microspheric form at least, following the proloculum and *Cornuspira*-like second chamber, arranged in a gradually widening spiral, followed by chambers extending in length and becoming annuli; chambers divided into chamberlets, each with one or more apertures on the rim of the test.

A rather full description is given of the development as the species are discussed and it need not be considered here.

#### ORBITOLITES MARGINALIS (Lamarck).

Plate 38, figs. 1, 2.

*Orbulites marginalis* LAMARCK, Hist. Nat. Anim. sans Vert., vol. 2, 1816, p. 196, No. 1.

*Orbiculina (Orbitolites) complanata* WILLIAMSON, Trans. Micr. Soc. London, ser. 1, vol. 3, 1851, p. 115, pl. 17, fig. 8; pl. 18, figs. 9, 10.

*Orbitolites marginalis* CARPENTER, Philos. Trans., 1856, p. 192, pl. 9, figs. 1-4, etc.; Rep. Voy. *Challenger*, Zoology, pt. 21, 1883, p. 20, pl. 3, figs. 1-7; pl. 4, figs. 1-5.—H. B. BRADY, Rep. Voy. *Challenger*, Zoology, vol. 9, 1884, p. 214, pl. 15, figs. 1-5.

*Description.*—Test circular or nearly so, flattened, chambers numerous, in a single layer, in the adult becoming annular, completely surrounding the periphery of the test; wall smooth, the area about each chamberlet slightly depressed, the center of the chamberlet slightly protuberant; apertures in a single row along the periphery of the test; the chamberlet communicating with one another by lateral openings just behind the periphery, these in turn opening backward into the preceding annular chamber.

Diameter, up to 5 mm., but usually smaller.

*Distribution.*—Bagg records this species as not very common at three *Albatross* stations near the Hawaiian Islands, D4000, in 104 to 212 fathoms; H4476, in 438 fathoms; and H4694, in 865 fathoms. I have had the species from the same region from the following stations: *Nero*, 2037, in 55 fathoms; 2038, in 34 fathoms; 2042, in 55 fathoms; 2043, in 58 fathoms; and 2071, in 271 fathoms; from *Nero* station 1466, in 234 fathoms off Guam, from *Alert* station 1177, in 23 to 118 fathoms, and from Gasper Straits, North Pacific Exploring Expedition, Captain Rodgers.

*Orbitolites marginalis* is a species which builds all its chambers, with slight exceptions, in a single plane. As a result a test is formed which when mounted in balsam may be viewed in optical section throughout. Its development is much less accelerated than that of the other species of *Orbitolites* and its study throws light on obscure points in the development of the higher, more complex species.

In figure 47 is shown the young of a megalospheric specimen of *O. marginalis*. There is a nearly spherical megalospheric proloculum (1) followed by an encircling *Cornuspira*-like chamber (2) making nearly a single coil. This differs from both *Peneroplis* and *Orbiculina*, which each had a second chamber but half a coil in length. This elongated second chamber is also seen in the other species

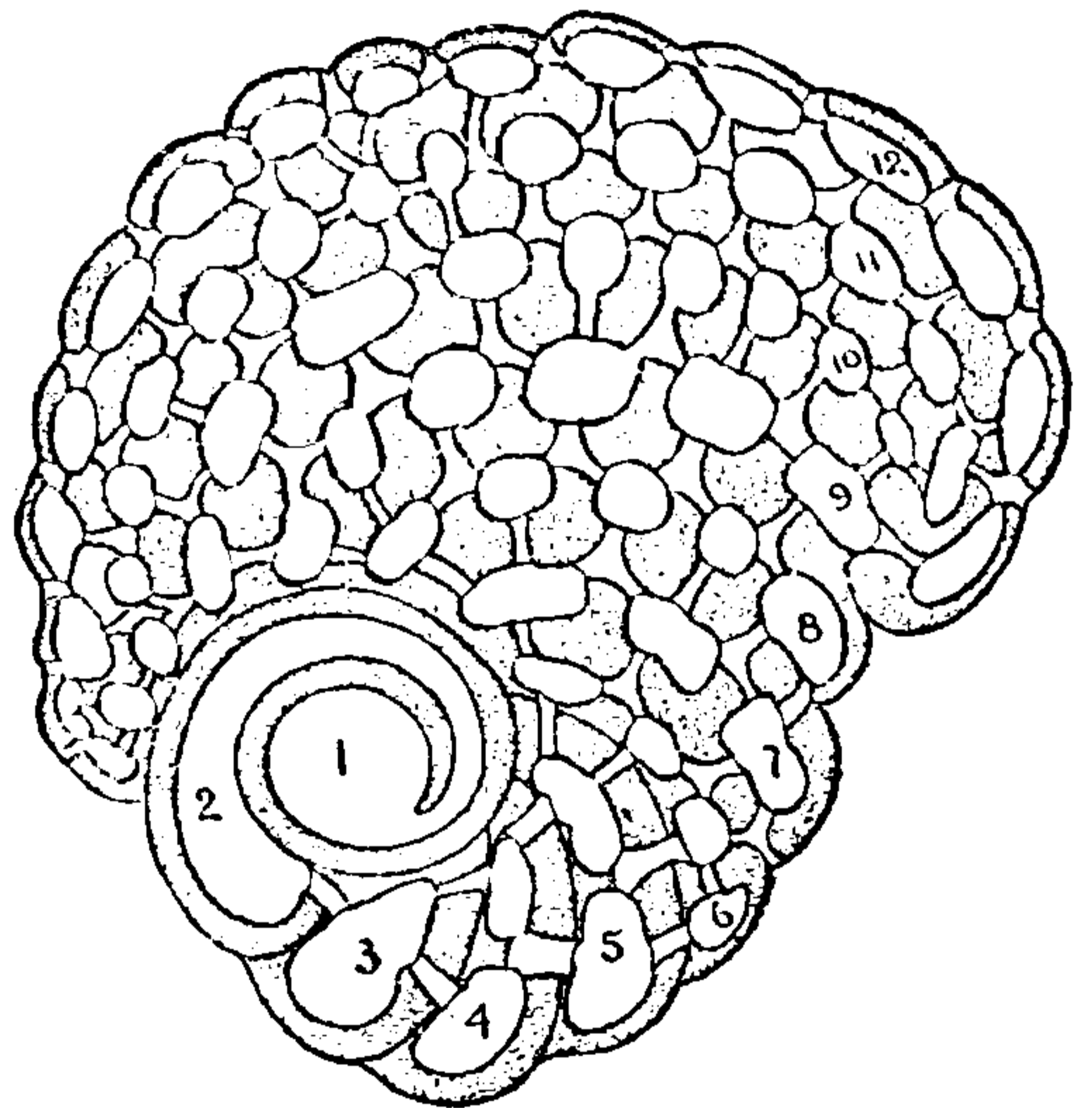

FIG. 47.—EARLY STAGES OF ORBITOLITES MARGINALIS,  $\times 50$ , IN OPTICAL SECTION.

of *Orbitolites* in the megalospheric form, sometimes being quite a full coil in length. The second chamber is very low at its inception, but gradually increases in height to its apertural end. The wall is continuous with that of the proloculum, of uniform thickness with it and builds no floor on the wall of the proloculum.

Chamber 3 is somewhat ovoid, not the globular form of the third chamber seen in *Peneroplis* and *Orbiculina*, but more like later chambers in those genera. It has two apertures instead of having a single one, as in the other genera mentioned; chamber 3 in this specimen of *O. marginalis* may be compared in this respect with the fourth chamber in *Orbiculina adunca*, with the eighth chamber in *Orbiculina compressa* or with the sixteenth chamber in the specimen of *Peneroplis*, figured by Schacko.

Chamber 4, however, becomes divided into two chamberlets by a median partition which is perforated near the apertural wall so that free communication exists between the chamberlets. The number of chamberlets increases rapidly in the succeeding chambers, as added, and the tenth chamber has nine chamberlets.

Up to and including chamber 10 the test is close coiled, although increasing rapidly in height, but with chamber 11 a new character is initiated, that of bending back on one side as was seen in chamber 21 in *Orbiculina compressa*.

Chamber 20 in this specimen of *Orbitolites marginalis* completes the circle of the periphery of the test and forms the first annulus. This corresponds with chamber 35 in *Orbiculina compressa*, where 15 chambers are necessary to complete the stage from the first bending back to the formation of the first annulus, which is in *Orbitolites marginalis* accomplished by the addition of but 10 chambers. This illustrates well the difference in the acceleration of development of these two specimens of the two different species.

#### ORBITOLITES DUPLEX Carpenter.

Plate 38, figs. 3, 4; plate 39, fig. 1.

*Orbitolites macropora* (?) LAMARCK, Hist. Nat. Anim. sans Vert., vol. 2, 1816, p. 197, No. 5 (fide Carpenter).

"*Orbitolites* (duplex type)" CARPENTER, Philos. Trans., 1856, p. 120, pl. 5, fig. 10; pl. 9, fig. 10.

*Orbitolites complanata*, var. *macropora* PARKER and JONES, Ann. Mag. Nat. Hist., ser. 3, vol. 5, 1860, p. 289.

*Orbitolites duplex* CARPENTER, Rep. Voy. Challenger, Zoology, pt. 21, 1883, p. 25, pl. 3, figs. 8-14; pl. 4, figs. 6-10; pl. 5, figs. 1-10.—H. B. BRADY, Rep. Voy. Challenger, Zoology, vol. 9, 1884, p. 216, pl. 16, fig. 7, fig. 7, in text.

*Description*.—Test in the form of a circular disk, the surface flat or slightly concave toward the center, chambers numerous, soon becoming annular; wall smooth, chambers and chamberlets obscurely marked, apertures in the adult consisting of a double row of openings on the periphery near the margin, corresponding to the double tier of chamberlets, usually alternating.

Diameter, up to 8 mm., but usually much less.

*Distribution*.—Apparently the only definite North Pacific record for this species is that of Rhumbler, who records the species from Laysan Island. Near the Hawaiian Islands it has occurred at *Nero* station 2033 in 249 fathoms and 2071 in 271 fathoms. It also occurred in some numbers at *Nero* station 1466 in 234 fathoms off Guam.

The first four chambers of a specimen of *Orbitolites duplex* with a megalospheric proloculum are shown in figure 48. As in *O. marginalis* there is an oval proloculum followed by a long *Cornuspira*-like chamber of nearly a coil in length of equal thickness with the proloculum and building no floor. Chamber 3 is simple with two apertures as in *O. marginalis*. Chamber 4 is divided into two chamberlets.

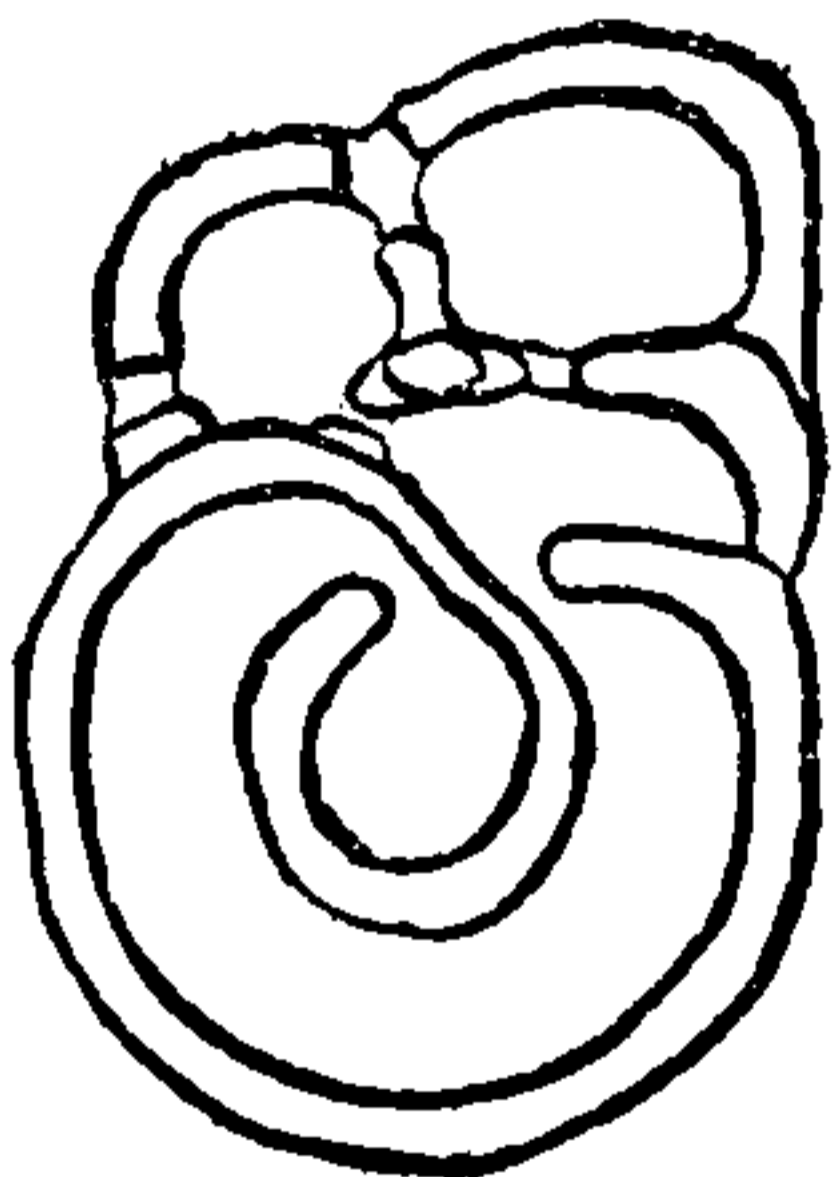

FIG. 48.—FIRST FOUR CHAMBERS OF ORBITOLITES DUPLEX,  $\times 100$ .

Instead of the outer wall of these last two chambers continuing the curve of the peripheral wall of the second chamber as in *O. marginalis*, *Orbiculina*, and *Peneroplis* a tangential direction is taken on as in much later chambers in the other types. The early development in this respect then is more accelerated than in *O. marginalis*. This acceleration continues for *O. duplex* may develop an annulus in the eighth chamber instead of in the twentieth as in *O. marginalis*. In the early stages there is a single series of apertures in the peripheral wall, but in adult growth two such series are usually present.

A very interesting and significant fact of the acceleration is shown in the stage at which the megalospheric young are freed from the parent test. In *Peneroplis* as already noted the young have a proloculum and the second *Cornuspira*-like chamber only when set free. The young of *Orbitolites marginalis* I have not seen in the parent test, but in *O. duplex* the young is usually set free in the stage as shown here, many young at this stage being found in the outer chambers of the parent test and also attached nearby. This is a comparatively much later stage than in *Peneroplis* and an earlier stage than seen in the next species.

The specimens from Guam in some cases show a plate-like lateral development across the face of the test on either side. One of these specimens is figured (pl. 39, fig. 1).

#### ORBITOLITES COMPLANATA Lamarck.

Plate 39, fig. 2.

"*Retepora Muscipula minima*," SOLDANI, Testaceographia, vol. 1, pt. 3, 1795, p. 242, pl. 167, figs. *ss, tt*; pl. 168, fig. *xx*.

*Orbitolites complanata* LAMARCK, Syst. Anim. sans Vert., 1801, p. 376.—CARPENTER, Rep. Voy. Challenger, Zoology, vol. 9, 1884, pt. 21, 1883, p. 29, pl. 5, figs. 14-18; pls. 6, 7, 8.—H. B. BRADY, Rep. Voy. Challenger, Zoology, vol. 9, 1884, p. 218, pl. 16, figs. 1-6; pl. 17, figs. 1-6.

*Description*.—Test in the form of a circular disk, the surfaces distinctly concave toward the center, periphery usually the thickest part of the test, convex in the middle, except the first three chambers all the chambers form annuli, divided into numerous chamberlets both in the circle and laterally so that in an adult specimen there may be three tiers of chamberlets in the annular chamber, an outer series on either side of a thicker central series, those of the outer series not communicating with one another but with the central series; wall nearly smooth; apertures very numerous.

Diameter, from 1 to 25 mm., the average being well under the medium of this range.

*Distribution*.—Brady records this species from the Loo Choo Islands and from the Hawaiian Islands. Bagg also records it from three stations in the latter region *Albatross* D4000 in 104 to 213 fathoms, H4476 in 438 fathoms, and H4566 in 572 fathoms.

I have had material from off the Hawaiian Islands, from Hongkong Harbor in 10 fathoms, from Cagayan, Sulu Islands, Philippines, and from *Tuscarora* station 60, in latitude  $21^{\circ} 14' N.$ ; longitude  $157^{\circ} 36' W.$  in 63 fathoms.

The species is very abundant in shallow waters of the East Indian region.

In the very large specimens with thickened edges the megalospheric young are often found in the outer chambers of the parent test. In these young four of which are figured here, there is an oval proloculum of very large size, followed by a second, *Cornuspira*-like chamber of about a quarter coil in length. This is, as usual, con-

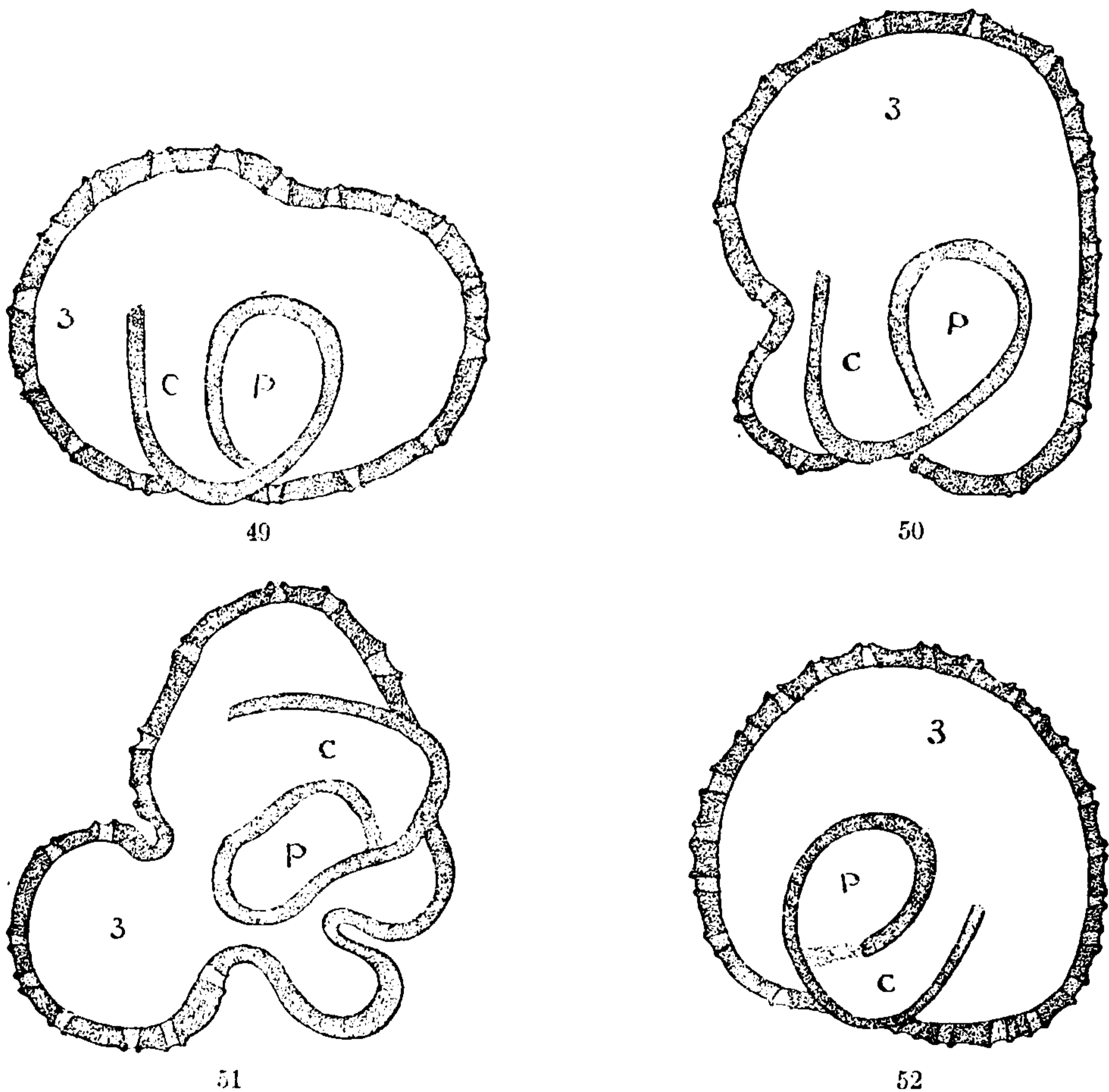

FIG. 49-52.—YOUNG SPECIMENS OF *ORBITOLITES COMPLANATA*, TAKEN FROM SAME "MOTHER" CELL,  $\times 36$ .  
P. PROLOCULUM, C, CORNUSPIRA-LIKE SECOND CHAMBER, 3 THIRD CHAMBER ABOUT WHICH THE FIRST ANNULAR CHAMBER DEVELOPS.

tinuous with the wall of the proloculum and builds no floor. Instead of being evenly curved its outer end often has a tendency to swing away from a uniform curve and to suggest the tangential direction seen in much later stages of the other two species discussed, thus initiating a character of later growth as early as the second chamber. The third chamber instead of being like the third chamber of the other types of the group is nearly an annulus, its ends not quite meeting on the peripheral wall of the second chamber. This point of contact as will be seen in the four specimens here figured is very

constant. At this stage the third chamber is often much contorted as shown in figures 49 to 51, especially marked in figure 51, where the periphery of the third chamber is greatly convoluted as though due to pressure. These young are often very crowded, and when formed the wall must be in a semi-plastic condition before it is hardened to account for the reëntrants in the wall such as show in figure 51. The outer rim of chamber 3 has numerous apertures. After the young is set free, it develops chamber 4 as a complete annulus with many chamberlets, comparable to the eighth chamber of *O. duplex* or to the twentieth chamber of *O. marginalis* showing the great acceleration that has taken place in *O. complanata*. From this point it builds annuli throughout further growth, each annulus becoming much divided and having several series of apertures on its peripheral wall.

Occasionally specimens of the megalospheric type are found with two prolocula and their accompanying later stages, but finally the two fusing and building as annulus in common, so that in later growth the synthetic test can not be distinguished from an ordinary individual with a single proloculum. This twinned condition is probably due to the closely adjacent position of the attached young when they started their annular growth. As the chambers met the protoplasm must have anastomosed and a common chamber been built. This tends to show the primitive character of the protoplasmic body.

#### Genus ALVEOLINA d'Orbigny, 1826.

*Alveolina* D'ORBIGNY, Ann. Sci. Nat., vol. 7, 1826, p. 306 (Type, *A. boscii* (Defrance)).—H. B. BRADY, Rep. Voy. *Challenger*, Zoology, vol. 9, 1884, p. 221.

*Description*.—Test usually elliptical or fusiform, composed in the adult of elongate chambers, each running the entire length of the test, the apertural face of the last formed chamber forming the growing edge of the test; chambers divided into chamberlets with small circular apertures upon the apertural face, at least in the larger species; whole test spirally coiled about the elongate axis.

This genus seems to be confined to the shallower waters of the Tropics, being a characteristic form in dredgings from about coral reefs.

#### ALVEOLINA MELO (Fichtel and Moll).

Plate 39, fig. 4.

*Nautilus melo* FICHTEL and MOLL, Test. Micr., 1803, p. 118, pl. 24.

*Alveolina melo* D'ORBIGNY, Ann. Sci. Nat., vol. 7, 1826, p. 306, No. 2.—H. B. BRADY, Rep. Voy. *Challenger*, Zoology, vol. 9, 1884, p. 223, pl. 17, figs. 13-15.

*Description*.—Test subspherical or broadly elliptical, coiling on its longitudinal axis, rotaliform at least in the adult; chambers in each whorl few, about eight in number, transversely striate; apertural face forming the growing edge of the test, truncate; apertures numer-

ous, consisting of a series of elliptical openings in a single row along the apertural face, each opening with a slight ridge about it.

Diameter, about 0.75 mm.

*Distribution*.—Brady records this species from off the Hawaiian Islands and this stands as the only record for the North Pacific. This is a rather isolated station as the nearest record given by Brady is Ceylon and this species does not seem to be found with the previous one in the East Indian region as it is in the West Indies.

It appears from these indications only that possibly there are more than two recent species, but without access to the material it is impossible to do more than suggest this as a possibility.

ALVEOLINA BOSCHII (Defrance).

Plate 39, fig. 3.

*Oryzaria boschii* DEFRANCE, Dict. Sci. Nat., vol. 16, 1820, p. 104.

*Alveolina boschii* D'ORBIGNY, Ann. Sci. Nat., vol. 7, 1826, p. 306, No. 5; Modèles, No. 50.—H. B. BRADY, Rep. Voy. *Challenger*, Zoology, vol. 9, 1884, p. 222, pl. 17, figs. 7-12.—CHAPMAN, Journ. Roy. Micr. Soc., 1908, pp. 151-153, pls. 1, 2, text. fig. 31.

*Description*.—Test elongate, fusiform, coiling on its longitudinal axis, the chambers very long, extending the whole length of the test, complex, transversely striate, apertural face forming the growing edge of the test, flattened; apertures very numerous, consisting of fine circular pores with raised borders scattered over the whole surface of the apertural face.

Length, 1.5 mm., in some regions up to nearly 1 inch.

*Distribution*.—The only North Pacific record for this species is that given by Brady, material taken by the *Challenger* in 40 fathoms, from the coral reefs of Honolulu, Hawaiian Islands. These specimens were small. I have had small specimens from *Tuscarora* station 60 in latitude 21° 14' N.; longitude 157° 36' W. in 63 fathoms, also in the vicinity of the Hawaiian Islands.

In the East Indian and Philippine regions this species grows to large size, nearly an inch in length. Both microspheric and megalospheric forms occur, the very large specimens being microspheric as shown by Chapman.



## EXPLANATION OF PLATES.

### PLATE 1.

- Fig. 1.** *Cornuspira foliacea*.  $\times 60$ . *a*, front view; *b*, apertural view.  
2. *Cornuspira involvens*.  $\times 40$ . *a*, front view; *b*, apertural view.

### PLATE 2.

- Fig. 1.** *Cornuspira foliacea*.  $\times 20$ . *a*, front view; *b*, apertural view.  
2. *Cornuspira involvens*.  $\times 40$ . *a*, front view; *b*, apertural view.  
3. *Cornuspira lacunosa*.  $\times 30$ . *a*, front view; *b*, apertural view.

### PLATE 3.

- Fig. 1.** *Ophthalmidium inconstans*.  $\times 65$ . Irregular specimen.  
2. *Ophthalmidium inconstans*.  $\times 65$ . A more regular specimen.  
3. *Ophthalmidium inconstans*.  $\times 135$ . Optical section of young specimen.  
4. *Ophthalmidium inconstans*.  $\times 65$ . Optical section of adult specimen.  
5. *Ophthalmidium tumidulum*.  $\times 33$  (after Brady).  
6. *Spiroloculina depressa*.  $\times 65$ . *a*, side view; *b*, apertural view.  
7. *Spiroloculina depressa*.  $\times 35$ . *a*, front view; *b*, apertural view of thicker specimen.  
8, 9. *Spiroloculina depressa*.  $\times 35$ . Apertures of adults.  
10. *Spiroloculina depressa*.  $\times 80$ . Aperture of young.

### PLATE 4.

- Fig. 1.** *Spiroloculina canaliculata*.  $\times 25$ . *a*, front view; *b*, apertural view.  
2. *Spiroloculina canaliculata*.  $\times 35$ . Apertural view.  
3. *Spiroloculina canaliculata*.  $\times 80$ . Apertural view of young.  
4. *Spiroloculina grateloupi*.  $\times 25$ . *a*, front view; *b*, side view; *c*, apertural view.  
5. *Spiroloculina grateloupi*.  $\times 35$ . *a*, front view; *b*, apertural view.

### PLATE 5.

- Fig. 1.** *Spiroloculina acutimargo*.  $\times 35$ .  
2. *Spiroloculina tenuimargo*.  $\times 65$ . *a*, front view; *b*, apertural view.  
3. *Spiroloculina tenuimargo*.  $\times 120$ . *a*, front view; *b*, apertural view.  
4. *Spiroloculina millettii*.  $\times 65$ . *a*, front view; *b*, side view; *c*, apertural view.  
5. *Spiroloculina nuda*.  $\times 65$ . *a*, front view; *b*, side view; *c*, apertural view.

### PLATE 6.

- Fig. 1.** *Spiroloculina costifera*.  $\times 35$ . *a*, front view; *b*, apertural view; *c*, section.  
2. *Spiroloculina costifera*.  $\times 30$ . *a*, front view; *b*, apertural view.  
3. *Spiroloculina costifera*.  $\times 35$ . End view of another specimen.

### PLATE 7.

- Fig. 1.** *Spiroloculina unicostata*.  $\times 135$ . *a*, front view; *b*, side view; *c*, apertural view.  
2. *Spiroloculina unicostata*.  $\times 135$ . *a*, front view; *b*, apertural view.  
3. *Spiroloculina grata*.  $\times 65$ . Front view.  
4. *Spiroloculina grata*.  $\times 75$ . Optical section.  
5. *Spiroloculina grata*, var. *angulata*.  $\times 30$ . *a*, front view; *b*, apertural view.

## PLATE 8.

- Fig. 1. *Nodobacularia tibia*.  $\times 130$ , showing proloculum, second *Cornuspira*-like chamber and the first of the uniserial chambers (after Rhumbler).  
 2. *Nodobacularia tibia*,  $\times 50$ , later chambers only (after Brady).  
 3. *Nodobacularia irregularis*.  $\times 95$  (after Rhumbler).  
 4. *Nubecularia bradyi*.  $\times 50$  (after Brady).  
 5. *Nubecularia bradyi*.  $\times 190$  (after Rhumbler).  
 6. *Nubecularia lucifuga*.  $\times 255$  (after Rhumbler).  
 7. *Quinqueloculina schauinslandi*.  $\times 35$  (after Rhumbler).  
 8. *Quinqueloculina schauinslandi*.  $\times 167$ , by transmitted light (after Rhumbler).

## PLATE 9.

- Fig. 1. *Quinqueloculina agglutinans*.  $\times 65$ . Hongkong. *a*, *b*, side views; *c*, apertural view.  
 2. *Quinqueloculina agglutinata*.  $\times 33$ . Off Alaska. *a*, *b*, side views; *c*, apertural view.

## PLATE 10.

- Fig. 1. *Quinqueloculina subarenaria*.  $\times 33$ . Off Hawaiian Islands. *a*, *b*, side views; *c*, apertural view.  
 2. *Quinqueloculina subarenaria*.  $\times 33$ . Off Singapore. *a*, *b*, side views; *c*, apertural view.

## PLATE 11.

- Fig. 1. *Quinqueloculina venusta*.  $\times 33$ . *a*, *b*, side views; *c*, apertural view.  
 2. *Quinqueloculina seminulum*.  $\times 65$ . *a*, *b*, side views.  
 3. *Quinqueloculina vulgaris*.  $\times 33$ . *a*, *b*, side views; *c*, apertural view.

## PLATE 12.

- Fig. 1. *Quinqueloculina auberiana*.  $\times 33$ . Albatross D4874. *a*, *b*, side views; *c*, apertural view.  
 2. *Quinqueloculina cuvieriana*.  $\times 65$ . Hongkong. *a*, *b*, side views; *c*, apertural view.

## PLATE 13.

- Fig. 1. *Quinqueloculina bicostata*.  $\times 65$ . Nero 1158. *a*, *b*, side views; *c*, apertural view.  
 2. *Quinqueloculina bicornis*.  $\times 65$ . Hongkong. *a*, *b*, side views; *c*, apertural view.

## PLATE 14.

- Fig. 1. *Quinqueloculina disparilis*,  $\times 65$ . Nero 1378. *a*, *b*, side views; *c*, apertural view.  
 2. *Quinqueloculina disparilis*, var. *curta*,  $\times 33$ . Albatross D4900. *a*, *b*, side views; *c*, apertural view.

## PLATE 15.

- Fig. 1. *Quinqueloculina costata*,  $\times 65$ . Nero 2041. *a*, *b*, side views; *c*, apertural view.  
 2. *Quinqueloculina boueana*,  $\times 65$ . Nero 2040. *a*, *b*, side views; *c*, apertural view.  
 3. *Quinqueloculina parkeri*,  $\times 33$ . Guam. *a*, *b*, side views; *c*, apertural view.

## PLATE 16.

- Fig. 1. *Quinqueloculina reticulata*,  $\times 33$ . Gaspar Straits.  
 2. *Quinqueloculina reticulata*,  $\times 33$ . Nero 2039.  
 3. *Quinqueloculina reticulata*,  $\times 65$ . Hongkong. *a*, front view; *b*, apertural view.

## PLATE 17.

- Fig. 1. *Triloculina cuneata*,  $\times 65$ . (After Rhumbler.)  
 2. *Triloculina deplanata*,  $\times 90$ . *a*, *b*, side views; *c*, apertural view. (After Rhumbler.)  
 3. *Quinqueloculina arenacea*,  $\times 140$ . (After Rhumbler.)  
 4. *Quinqueloculina arenacea*,  $\times 140$ . (After Rhumbler.)  
 5. *Quinqueloculina ferox*,  $\times 54$ . (After Rhumbler.)  
 6. *Quinqueloculina ferox*,  $\times 43$ . (After Rhumbler.)  
 7. *Quinqueloculina ferox*,  $\times 57$ . (After Rhumbler.)  
 8. *Triloculina cribrostoma*,  $\times 25$ . (After Rhumbler.)  
 9. *Adelosina laysanensis*,  $\times 288$ . (After Rhumbler.)  
 10. *Triloculina cylindrica*,  $\times 140$ . (After Rhumbler.)

## PLATE 18.

- Fig. 1. *Quinqueloculina dutemplei*,  $\times 65$ . *a*, *b*, side views; *c*, apertural view.  
 2. *Quinqueloculina bradyana*,  $\times 40$ . *a*, *b*, side views; *c*, apertural view.  
 3. *Quinqueloculina dutemplei?*,  $\times 33$ . *a*, *b*, side views; *c*, apertural view.

## PLATE 19.

- Fig. 1. *Planispirina sphaera*,  $\times 65$ . *a*, front view; *b*, side view.  
 2. *Quinqueloculina procera*,  $\times 35$ . Horizontal section.  
 3. *Quinqueloculina ferussacii*,  $\times 65$ . *a*, *b*, side views; *c*, apertural view.  
 4. *Quinqueloculina ferussacii*,  $\times 65$ . End view of another specimen.

## PLATE 20.

- Fig. 1. *Quinqueloculina spiralis*,  $\times 65$ . *a*, *b*, side views; *c*, apertural view.  
 2. *Massilina crenata*,  $\times 65$ . *a*, front view; *b*, apertural view.  
 3. *Massilina connectans*,  $\times 65$ . *a*, *b*, side views; *c*, apertural view.

## PLATE 21.

- Fig. 1. *Quinqueloculina cultrata*,  $\times 33$ . *a*, side view; *b*, apertural view.  
 2. *Hauerina pacifica*,  $\times 65$ . *a*, *b*, side views; *c*, apertural view.  
 3. *Triloculina suborbicularis*,  $\times 135$ . *a*, *b*, side views; *c*, apertural view.

## PLATE 22.

- Fig. 1. *Vertebralina insignis*,  $\times 35$ . (After Brady.)  
 2. *Vertebralina insignis*,  $\times 35$ . *a*, front view; *b*, apertural view. (After Brady.)  
 3. *Vertebralina striata*,  $\times 65$ .  
 4. *Vertebralina striata*,  $\times 65$ . *a*, front view; *b*, apertural view.  
 5. *Vertebralina sulcata*,  $\times 65$ . *a*, front view; *b*, apertural view.  
 6. *Articulina conico-articulata*,  $\times 65$ . *a*, front view; *b*, apertural view.  
 7. *Articulina sagra*,  $\times 35$ . (After Brady.)  
 8. *Articulina sagra*,  $\times 35$ . (After Brady.)

## PLATE 23.

- Fig. 1. *Hauerina ornatissima*,  $\times 65$ . *a*, front view; *b*, apertural view.  
 2. *Hauerina bradyi*,  $\times 65$ . *a*, front view; *b*, apertural view.  
 3. *Hauerina circinata*,  $\times 33$ . (After Brady.)  
 4. *Hauerina circinata*,  $\times 33$ . (After Brady.)  
 5. *Hauerina ornatissima*,  $\times 65$ . *a*, front view; *b*, apertural view.

## PLATE 24.

- Fig. 1. *Sigmoilina celata*,  $\times 65$ . *a*, front view; *b*, apertural view.  
 2. *Sigmoilina sigmoidea*,  $\times 65$ . *a*, front view; *b*, apertural view.  
 3. *Sigmoilina sigmoidea*, section,  $\times 40$ . (After Brady.)  
 4. *Hauerina fragilissima*,  $\times 65$ . *a*, front view; *b*, apertural view.

## PLATE 25.

- Fig. 1. *Triloculina tricarinata*,  $\times 30$ . *a*, front view; *b*, apertural view of very large specimen.  
 2. *Triloculina tricarinata*,  $\times 33$ . *a*, front view; *b*, apertural view.  
 3. *Triloculina trigonula*,  $\times 33$ . *a*, front view; *b*, apertural view.  
 4. *Triloculina circularis*,  $\times 65$ . *a*, *b*, side views; *c*, apertural view.

## PLATE 26.

- Fig. 1. *Triloculina circularis*,  $\times 33$ . *a*, front view; *b*, apertural view.  
 2. *Triloculina circularis*, var. *sublineata*,  $\times 65$ . *a*, *b*, side views.  
 3. *Triloculina oblonga*,  $\times 33$ . *a*, front view; *b*, apertural view.

## PLATE 27.

- Fig. 1. Triloculine stage of *Biloculina*,  $\times 65$ . *a*, front view; *b*, apertural view.  
 2. *Triloculina terquemiana*,  $\times 65$ . *a*, front view; *b*, apertural view.  
 3. *Triloculina insignis*,  $\times 65$ . *a*, front view; *b*, apertural view.  
 4. *Triloculina linnaeana*,  $\times 33$ . *a*, front view; *b*, apertural view.

## PLATE 28.

- Fig. 1. *Biloculina depressa*,  $\times 33$ . *a*, front view; *b*, side view; *c*, apertural view.  
 2. *Biloculina depressa*,  $\times 33$ . *a*, front view; *b*, apertural view.  
 3. *Biloculina murrhyna*,  $\times 33$ . *a*, front view; *b*, apertural view.

## PLATE 29.

- Fig. 1. *Biloculina murrhyna*,  $\times 65$ . *a*, front view; *b*, side view; *c*, apertural view.  
 2. *Biloculina serrata*,  $\times 65$ . *a*, front view; *b*, side view; *c*, apertural view, specimen with irregular margin.

## PLATE 30.

- Fig. 1. *Biloculina respertilio*,  $\times 20$ . *a*, front view; *b*, side view; *c*, apertural view of very large specimen.  
 2. *Biloculina sarsii*,  $\times 33$ . *a*, front view; *b*, apertural view.

## PLATE 31.

- Fig. 1. *Biloculina elongata*,  $\times 33$ . *a*, front view; *b*, side view; *c*, apertural view.  
 2. *Biloculina globulus*,  $\times 65$ . *a*, front view; *b*, side view; *c*, apertural view.

## PLATE 32.

- Fig. 1. *Biloculina anomala*,  $\times 65$ . *a*, front view; *b*, side view; *c*, apertural view.  
 2. *Biloculina lucernula*,  $\times 65$ . *a*, front view; *b*, side view; *c*, apertural view.

## PLATE 33.

- Fig. 1. *Biloculina denticulata*,  $\times 65$ . *a*, front view; *b*, side view; *c*, apertural view.  
 2. *Biloculina denticulata*, var. *striolata*,  $\times 65$ . *a*, front view; *b*, apertural view.  
 3. *Biloculina denticulata*, var. *striolata*,  $\times 33$ . *a*, front view; *b*, apertural view.

## PLATE 34.

- Fig. 1. *Biloculina comata*,  $\times 33$ . *a*, front view; *b*, apertural view.  
 2. *Biloculina comata*, var. *serratula*,  $\times 33$ .  
 3. *Biloculina comata*, var. *serratula*,  $\times 33$ . *a*, front view; *b*, apertural view.  
 4. *Biloculina millettii*,  $\times 33$ . *a*, front view; *b*, apertural view.  
 5. *Biloculina millettii*,  $\times 33$ .  
 6. *Biloculina semicostata*,  $\times 33$ . *a*, front view; *b*, side view; *c*, apertural view.

## PLATE 35.

- Fig. 1. *Biloculina flintii*,  $\times 33$ . *a*, front view; *b*, side view; *c*, apertural view.  
 2. *Nevillina coronata*,  $\times 25$ . Showing penultimate chamber within.  
 3. *Nevillina coronata*,  $\times 25$ . *a*, front view; *b*, apertural view.  
 4. *Nevillina coronata*,  $\times 25$ . Triloculine stage.  
 5. *Nevillina coronata*,  $\times 25$ . Biloculine stage. (Figs. 2-5 after Sidebottom.)

## PLATE 36.

- Fig. 1. *Peneroplis pertusus*,  $\times 33$ . *a*, side view; *b*, apertural view.  
 2. *Peneroplis pertusus*, var. *arictinus*,  $\times 33$ . *a*, front view; *b*, apertural view.  
 3. *Peneroplis pertusus*, var.  $\times 33$ . *a*, side view; *b*, apertural view.

## PLATE 37.

- Fig. 1. *Peneroplis pertusus*,  $\times 20$ . Aperture.  
 2. *Peneroplis pertusus*,  $\times 20$ . Aperture.  
 3. *Peneroplis pertusus*, var. *planatus*,  $\times 65$ . *a*, side view; *b*, apertural view.  
 4. *Peneroplis pertusus*, var. *carinatus*,  $\times 33$ . *a*, side view; *b*, apertural view.  
 5. *Peneroplis pertusus*, var. *arictinus*,  $\times 27$ . Section. (After Brady.)  
 6. *Peneroplis pertusus*,  $\times 33$ . Aperture.  
 7, 8. *Orbiculina adunca*,  $\times 20$ . (After Brady.)

## PLATE 38.

- Fig. 1. *Orbitolites marginalis*,  $\times 30$ . *a*, surface view; *b*, peripheral view.  
 2. *Orbitolites marginalis*,  $\times 65$ . Apertures.  
 3. *Orbitolites duplex*,  $\times 75$ . Apertures.  
 4. *Orbitolites duplex*,  $\times 33$ . *a*, surface view; *b*, peripheral view.

## PLATE 39.

- Fig. 1. *Orbitolites duplex*,  $\times 30$ . Specimen with secondary growth.  
 2. *Orbitolites complanata*,  $\times 30$ . *a*, surface view; *b*, peripheral view.  
 3. *Alveolina bosci*,  $\times 12$ . *a*, front view; *b*, end view. (After Brady.)  
 4. *Alveolina melo*,  $\times 33$ . *a*, front view; *b*, end view. (After Brady.)

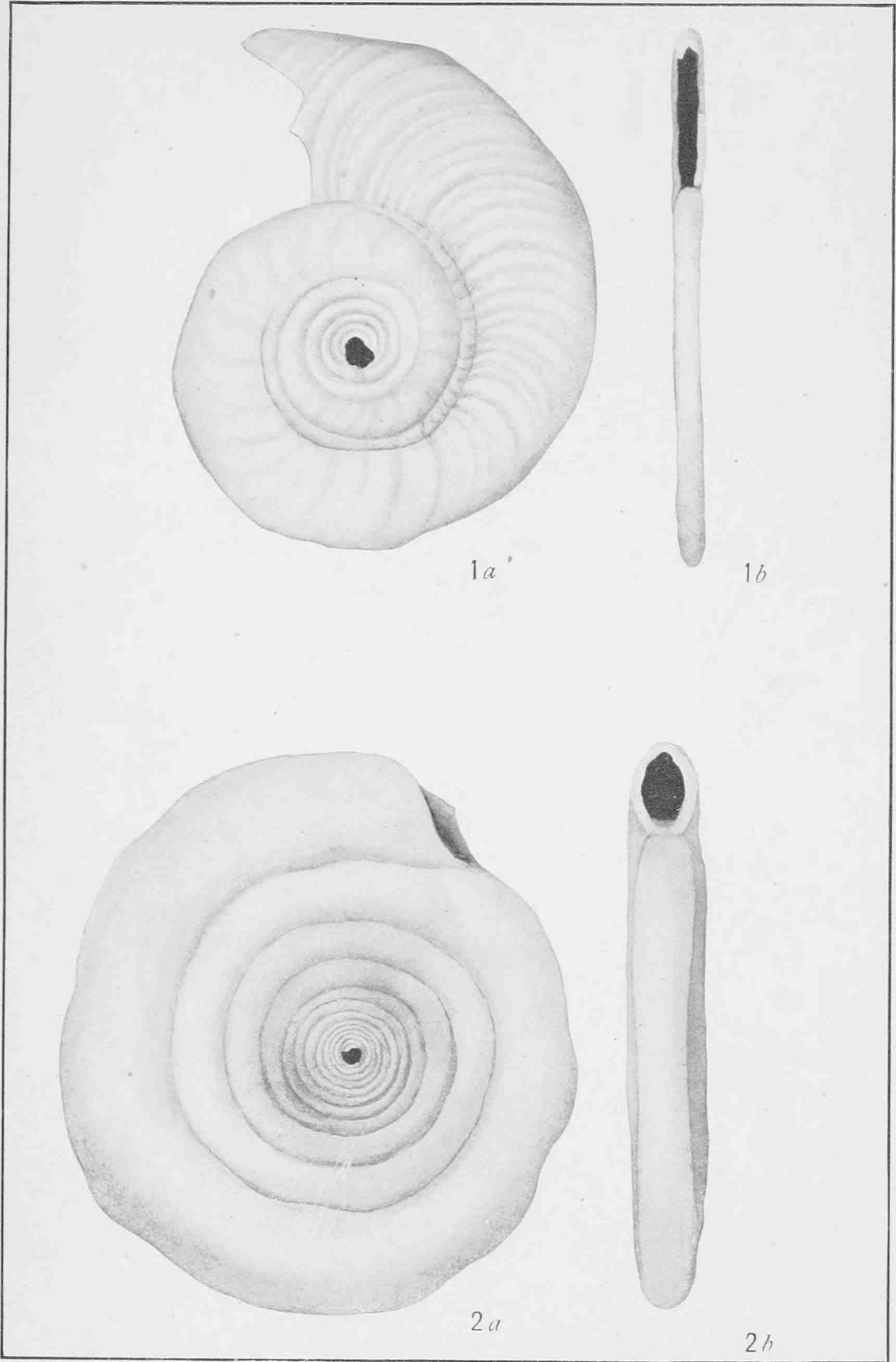

MILIOLIDAE OF NORTH PACIFIC OCEAN.

FOR EXPLANATION OF PLATE SEE PAGE 99.

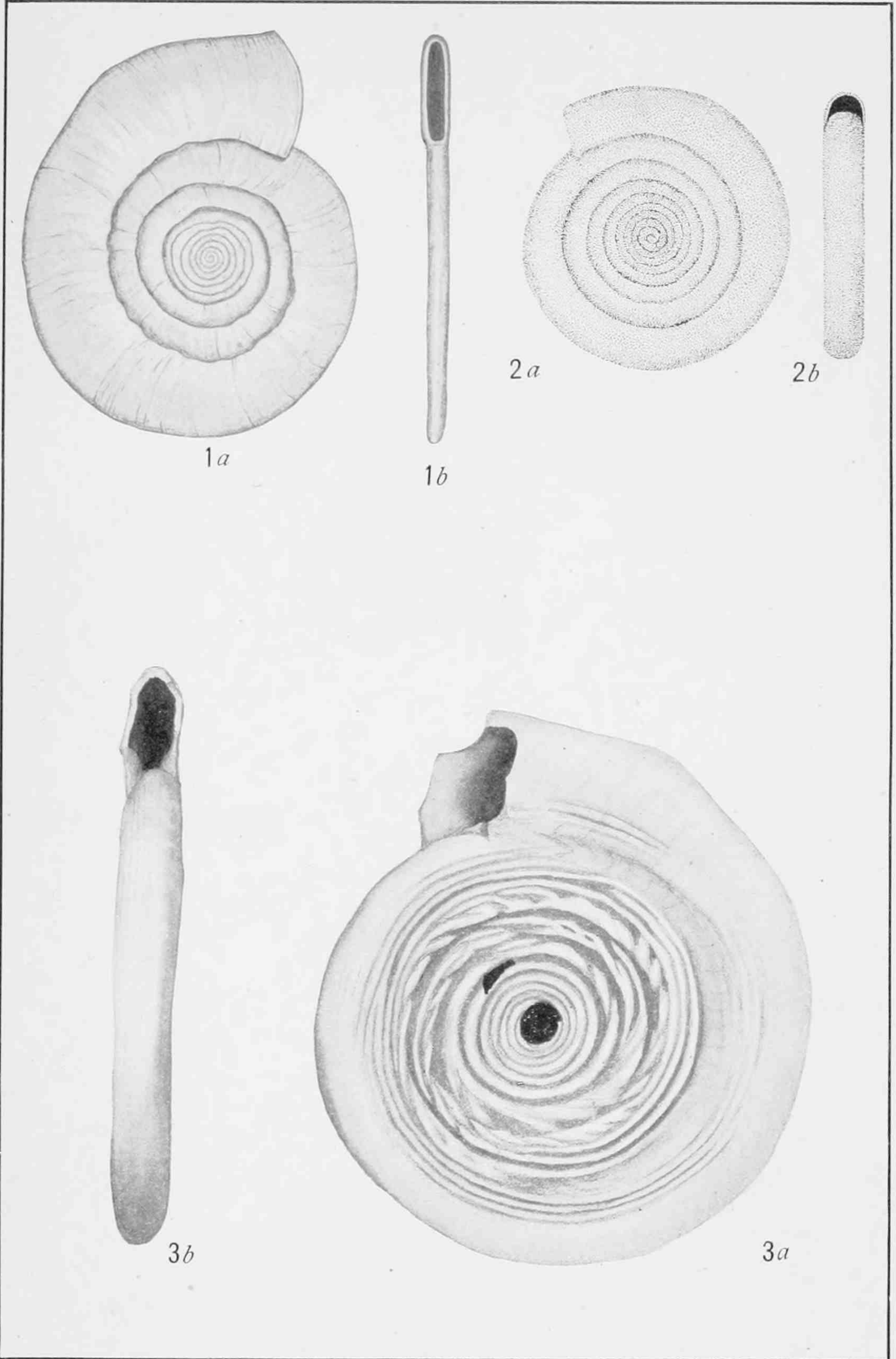

MILIOLIDAE OF NORTH PACIFIC OCEAN.

FOR EXPLANATION OF PLATE SEE PAGE 99.

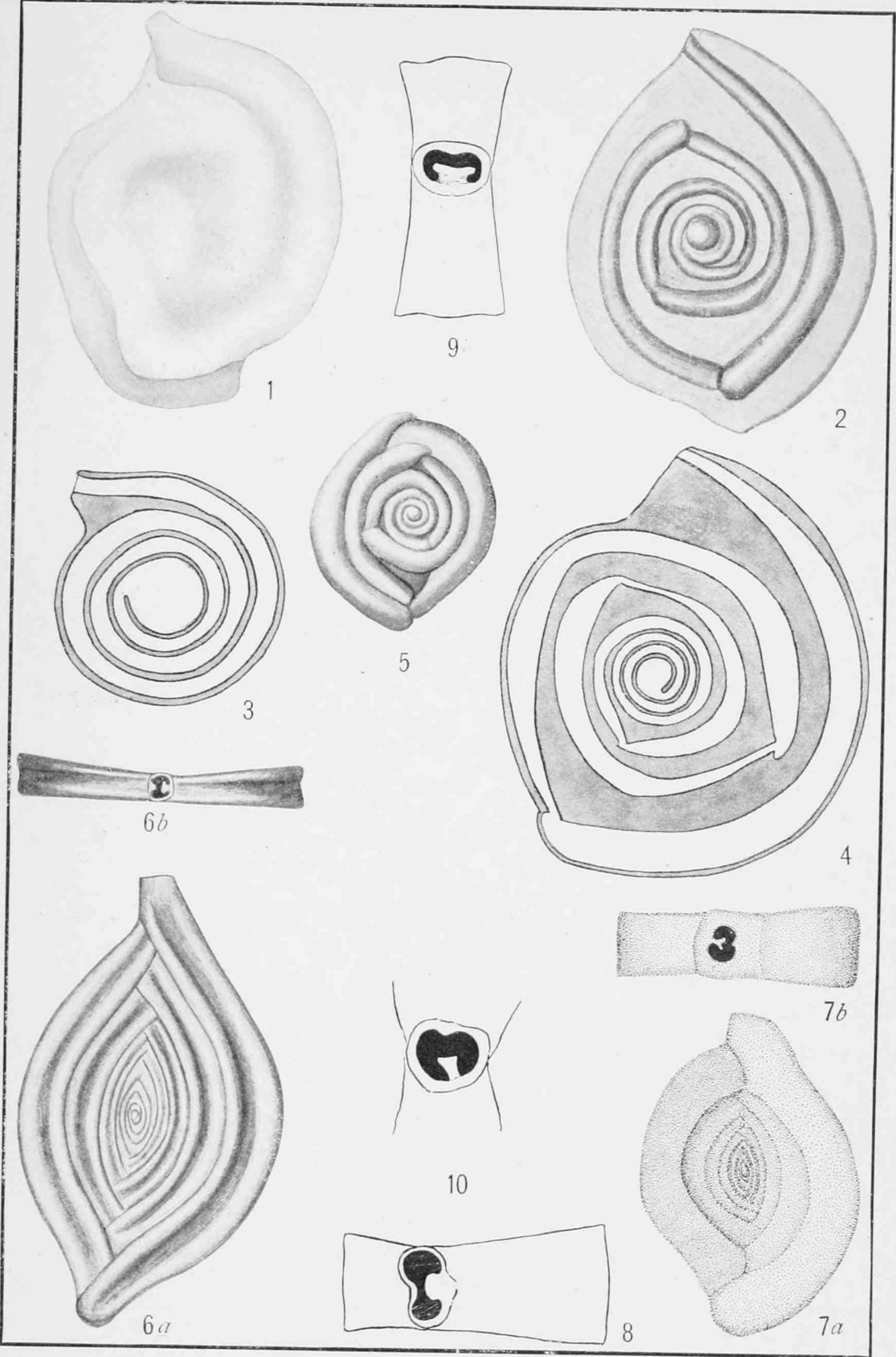

MILIOLIDAE OF NORTH PACIFIC OCEAN.

FOR EXPLANATION OF PLATE SEE PAGE 99.



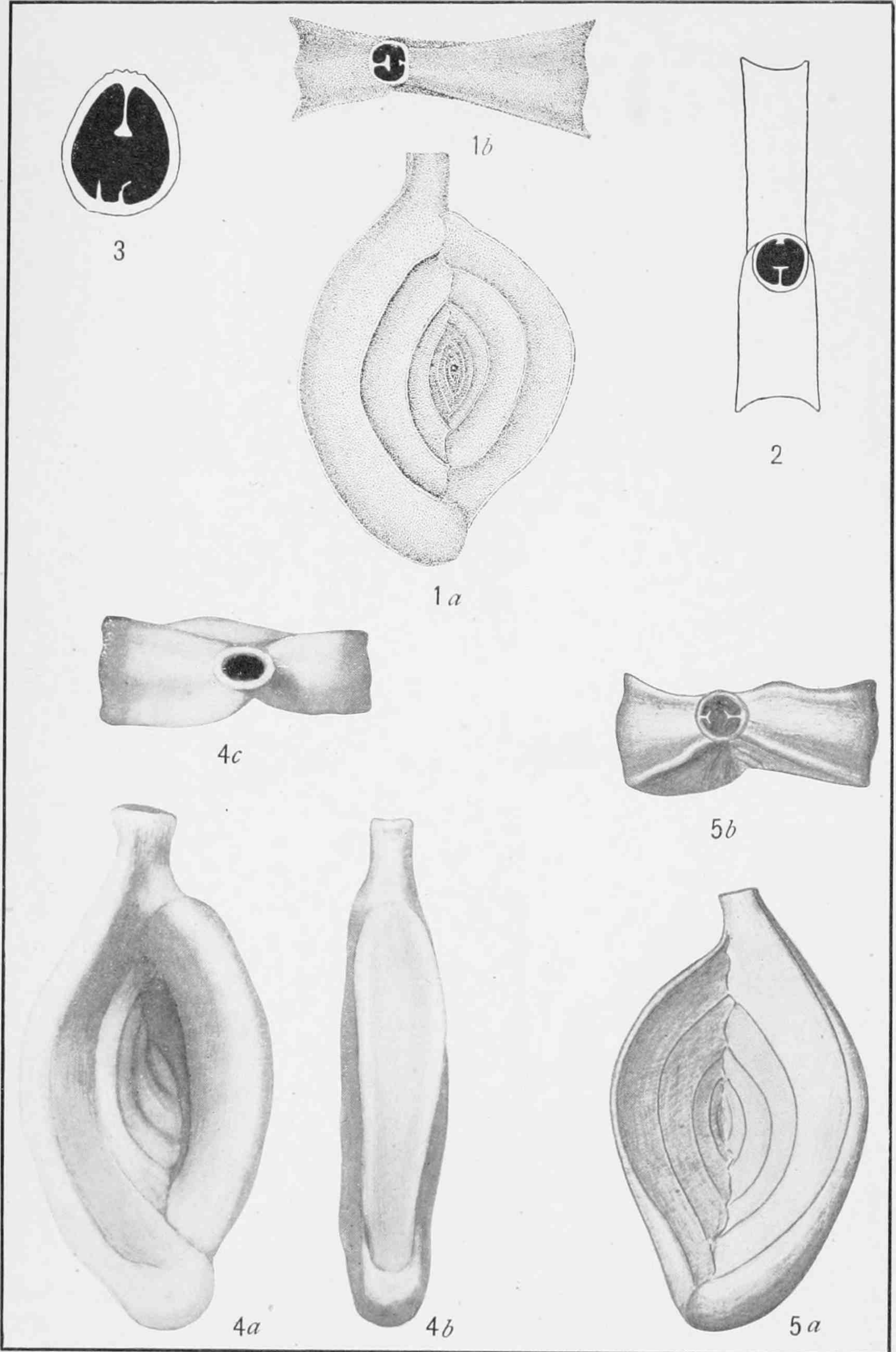

MILIOLIDAE OF NORTH PACIFIC OCEAN.

FOR EXPLANATION OF PLATE SEE PAGE 99.

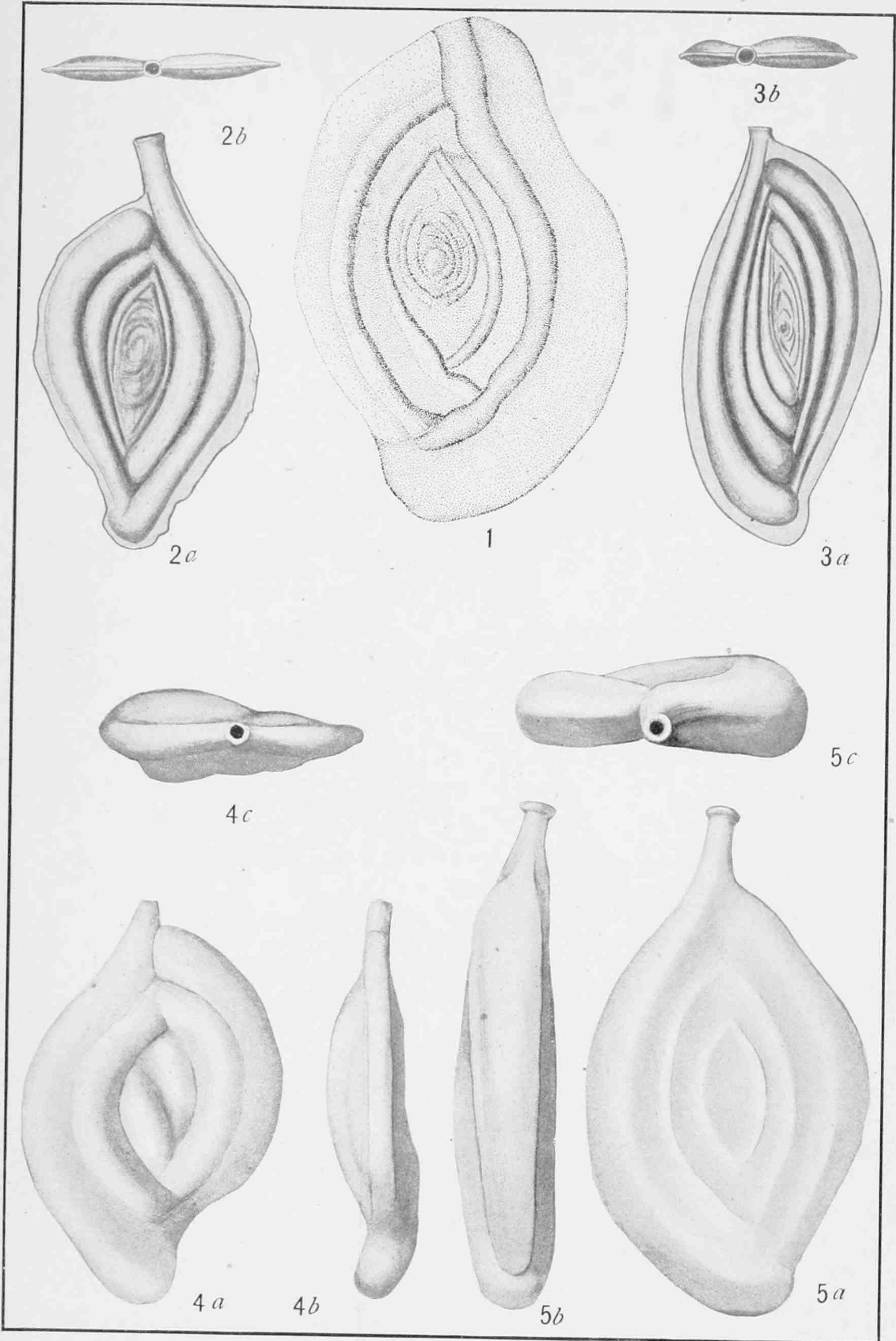

MILIOLIDAE OF NORTH PACIFIC OCEAN.

FOR EXPLANATION OF PLATE SEE PAGE 99.

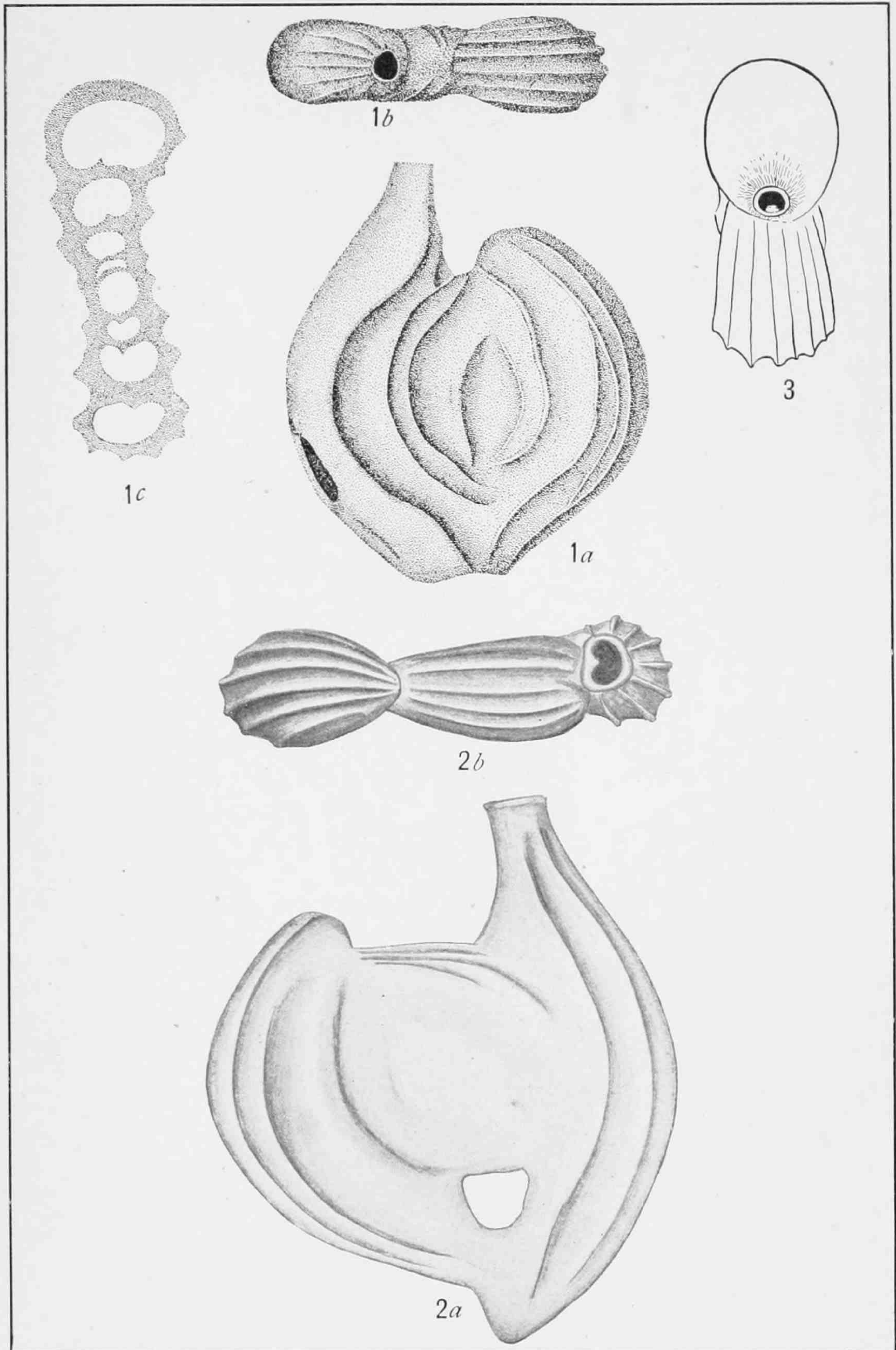

MILIOLIDAE OF NORTH PACIFIC OCEAN.

FOR EXPLANATION OF PLATE SEE PAGE 99.

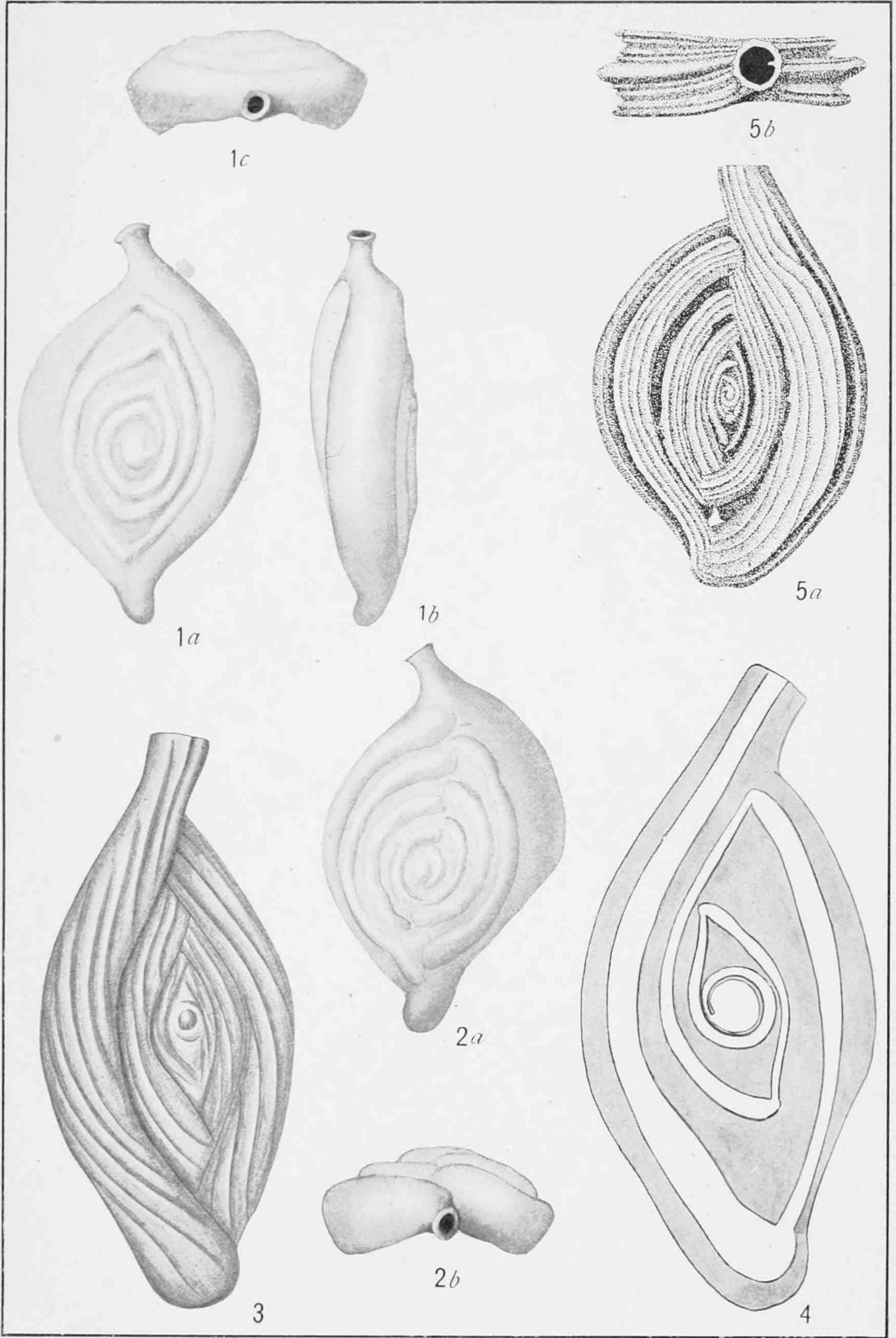

MILIOLIDAE OF NORTH PACIFIC OCEAN.

FOR EXPLANATION OF PLATE SEE PAGE 99.

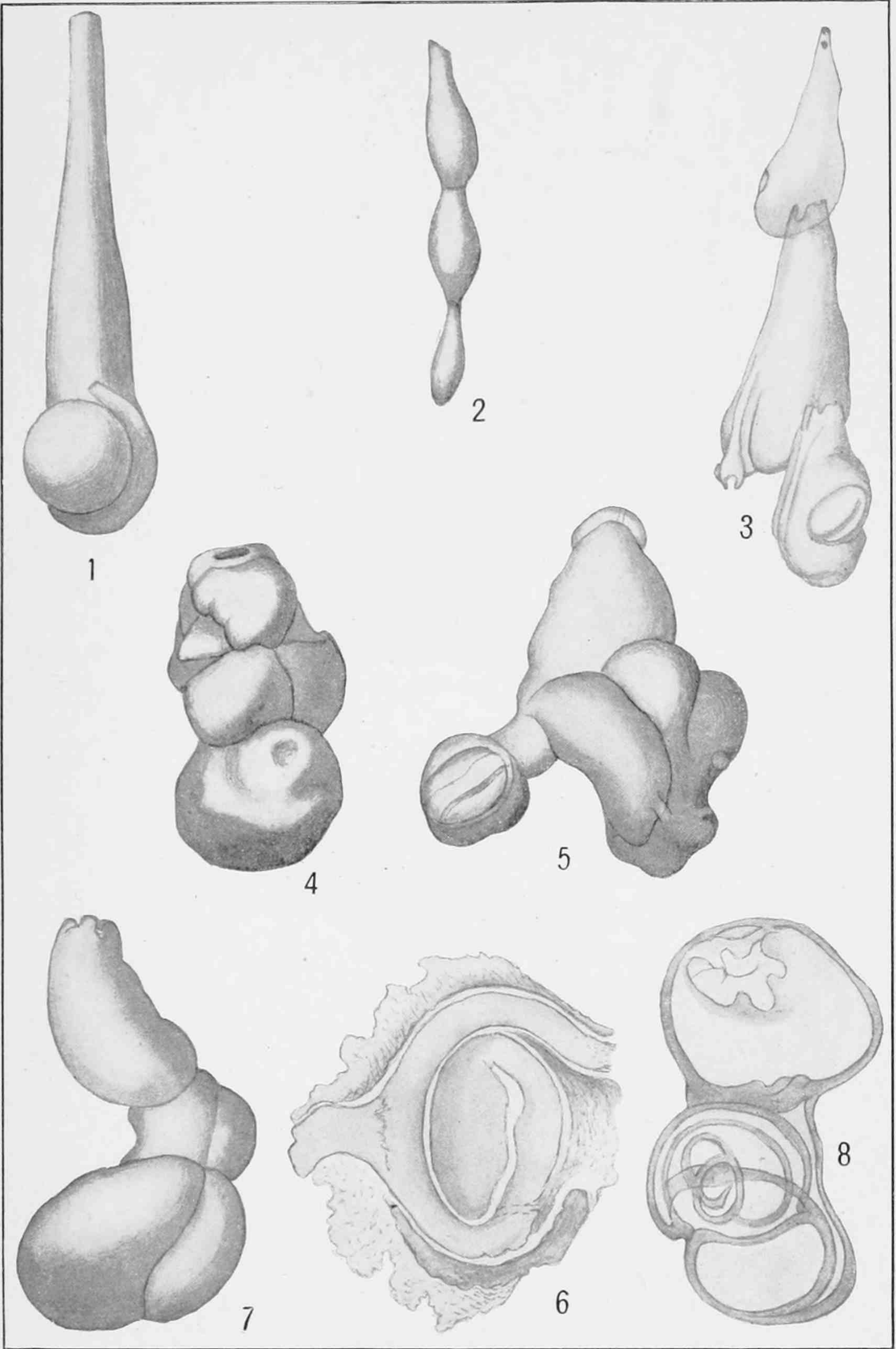

MILIOLIDAE OF NORTH PACIFIC OCEAN.

FOR EXPLANATION OF PLATE SEE PAGE 100.

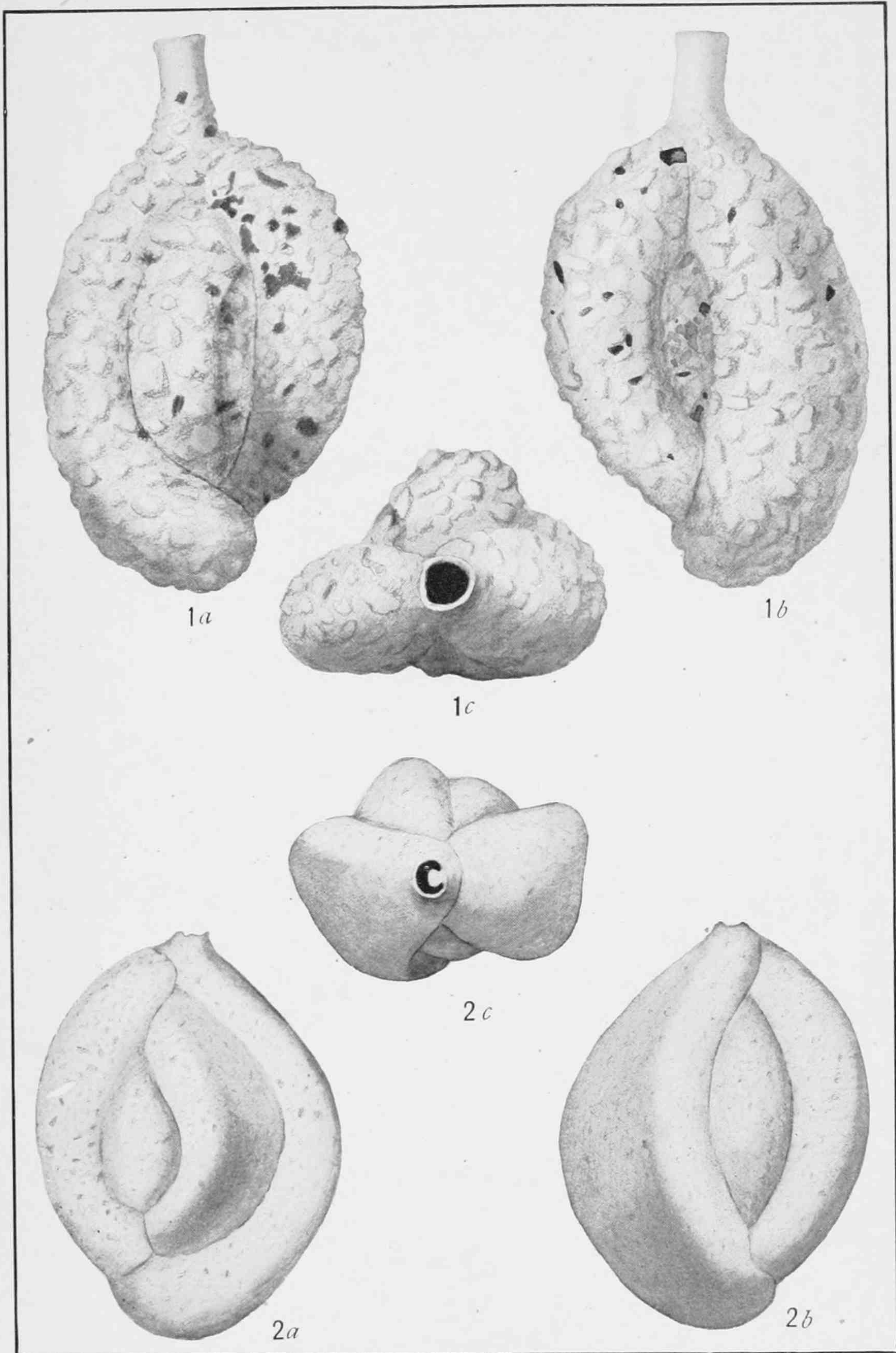

MILIOLIDAE OF NORTH PACIFIC OCEAN.

FOR EXPLANATION OF PLATE SEE PAGE 100.

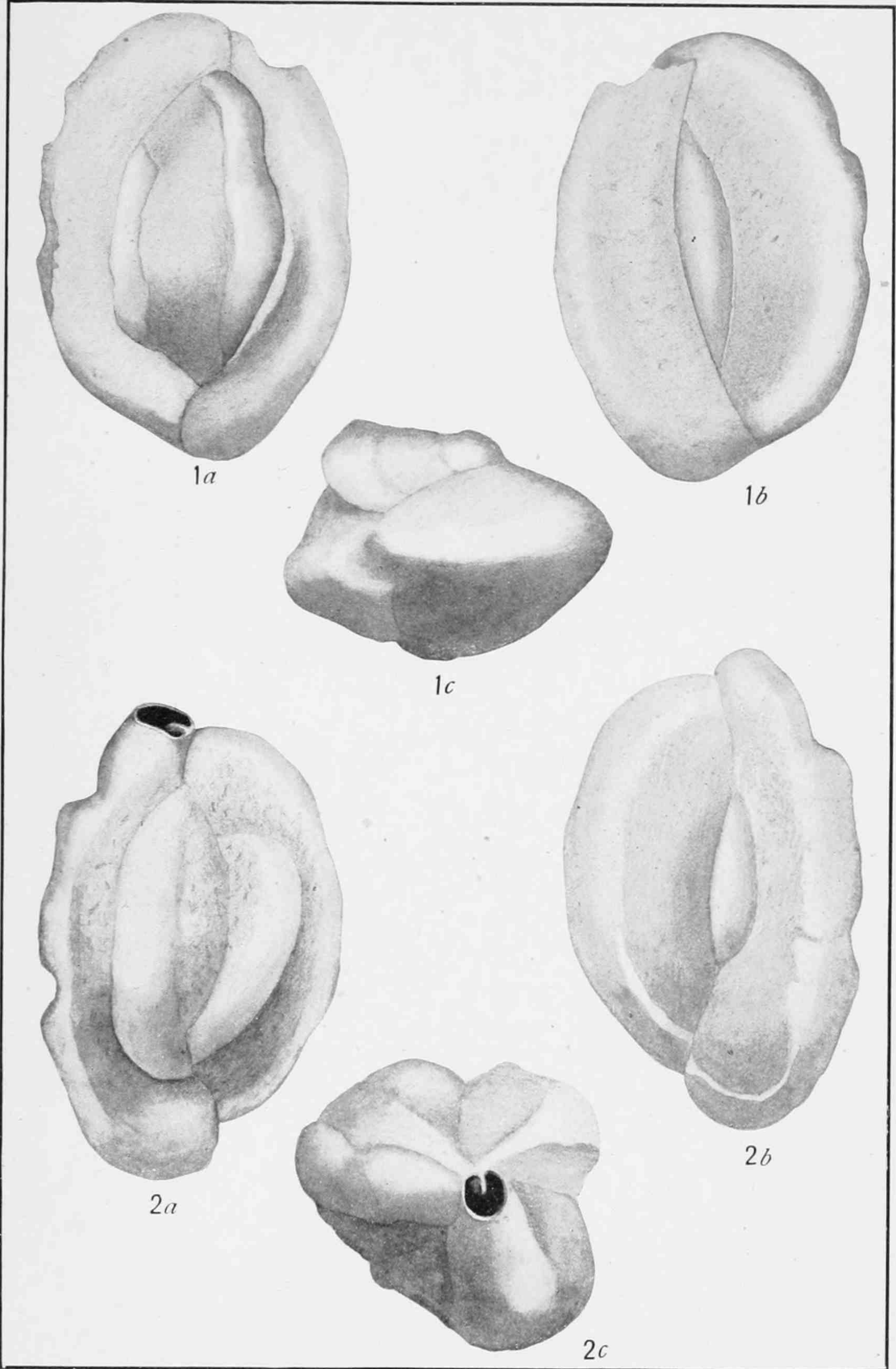

MILIOLIDAE OF NORTH PACIFIC OCEAN.

FOR EXPLANATION OF PLATE SEE PAGE 100.

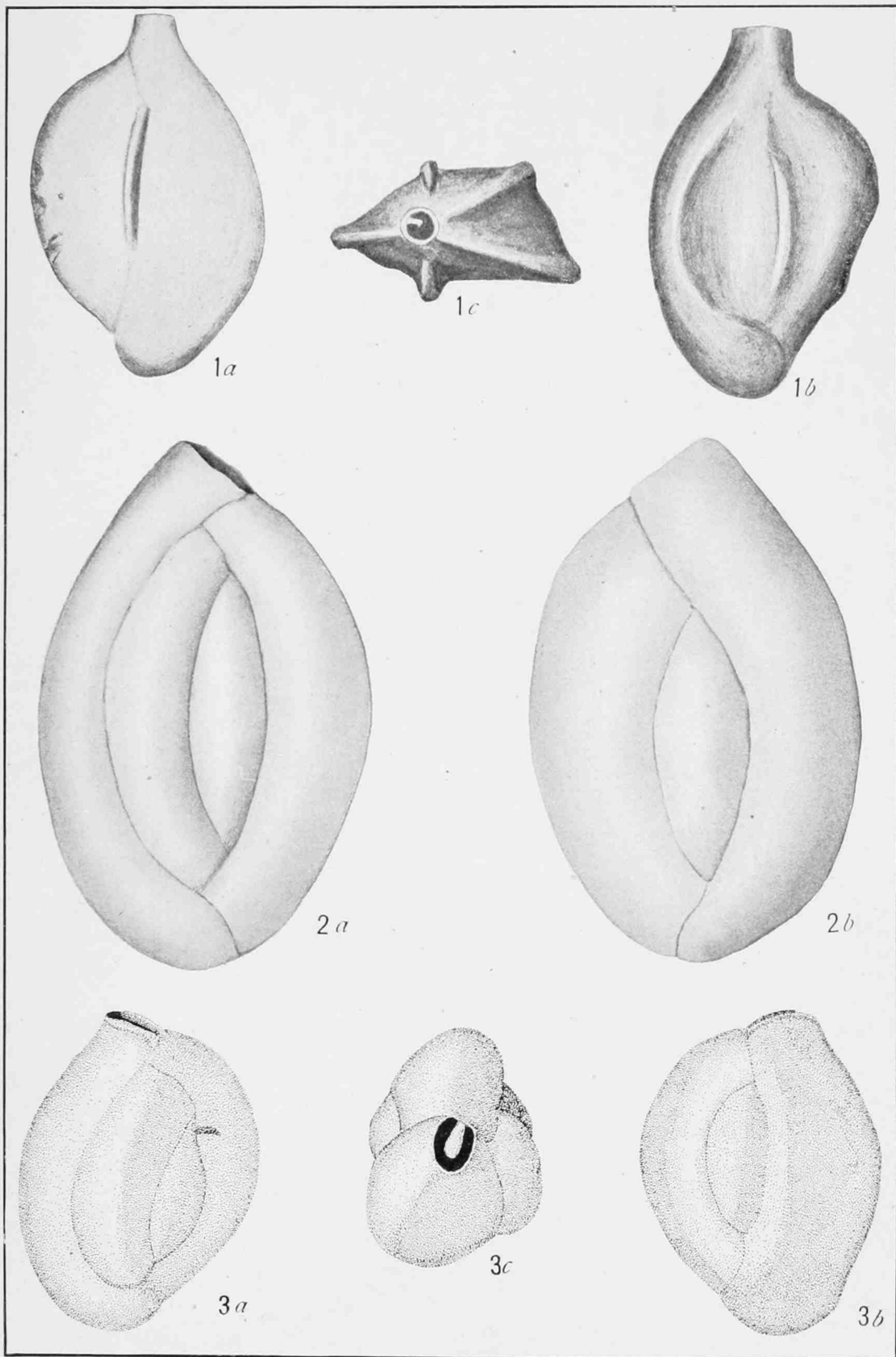

MILIOLIDAE OF NORTH PACIFIC OCEAN.

FOR EXPLANATION OF PLATE SEE PAGE 100.



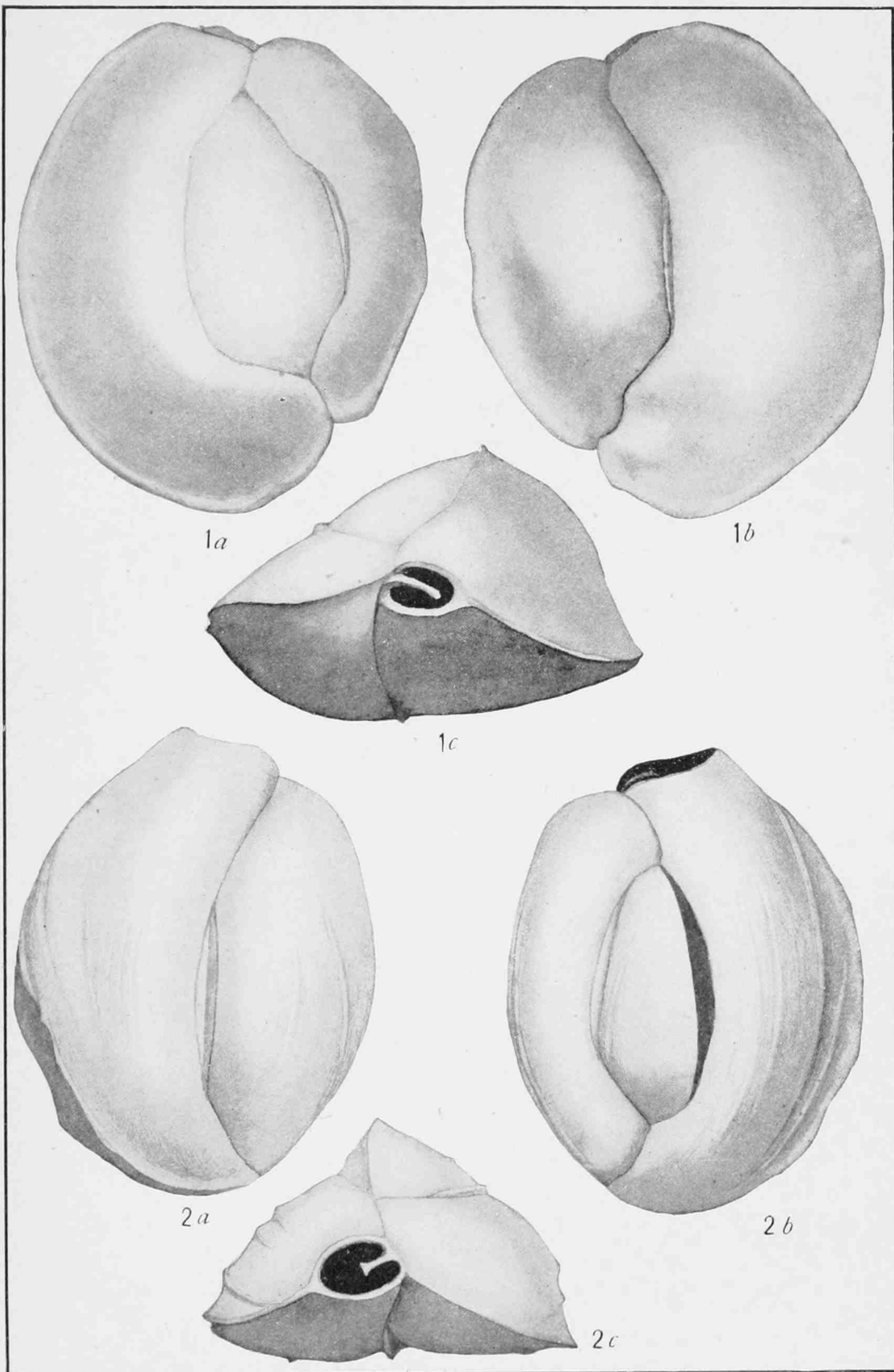

MILIOLIDAE OF NORTH PACIFIC OCEAN.

FOR EXPLANATION OF PLATE SEE PAGE 100.

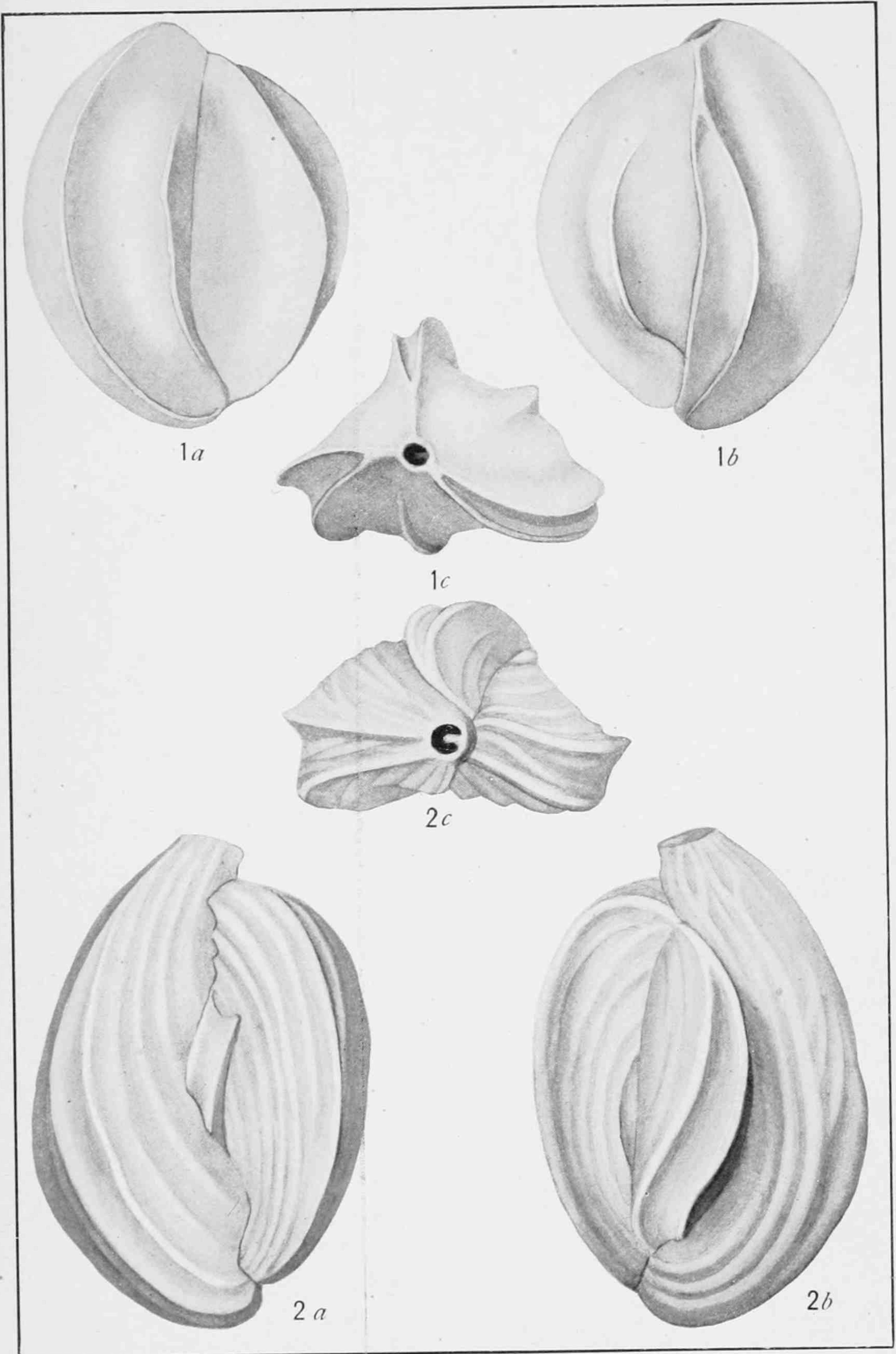

MILIOLIDAE OF NORTH PACIFIC OCEAN.

FOR EXPLANATION OF PLATE SEE PAGE 100.

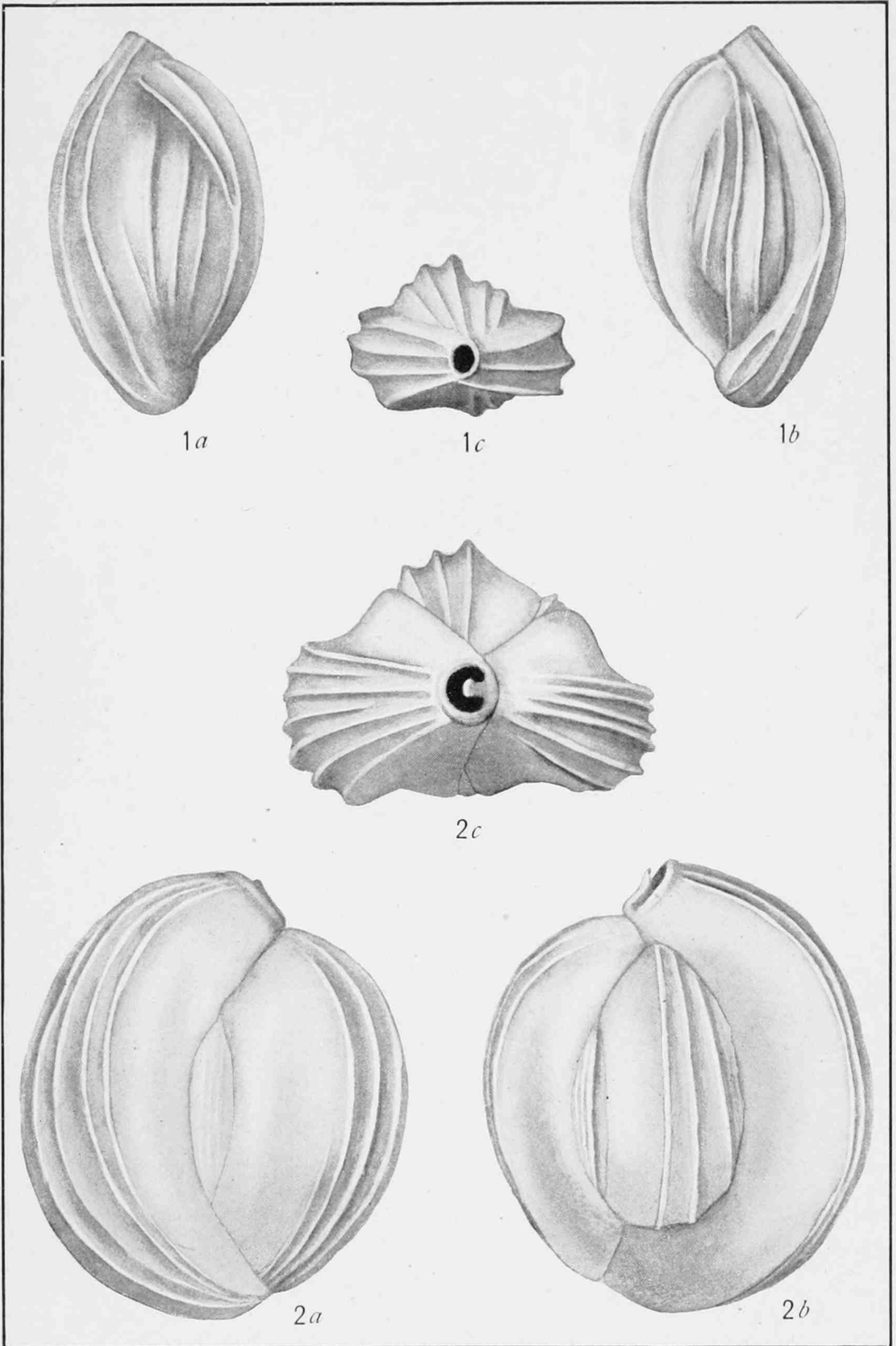

MILIOLIDAE OF NORTH PACIFIC OCEAN.

FOR EXPLANATION OF PLATE SEE PAGE 100.

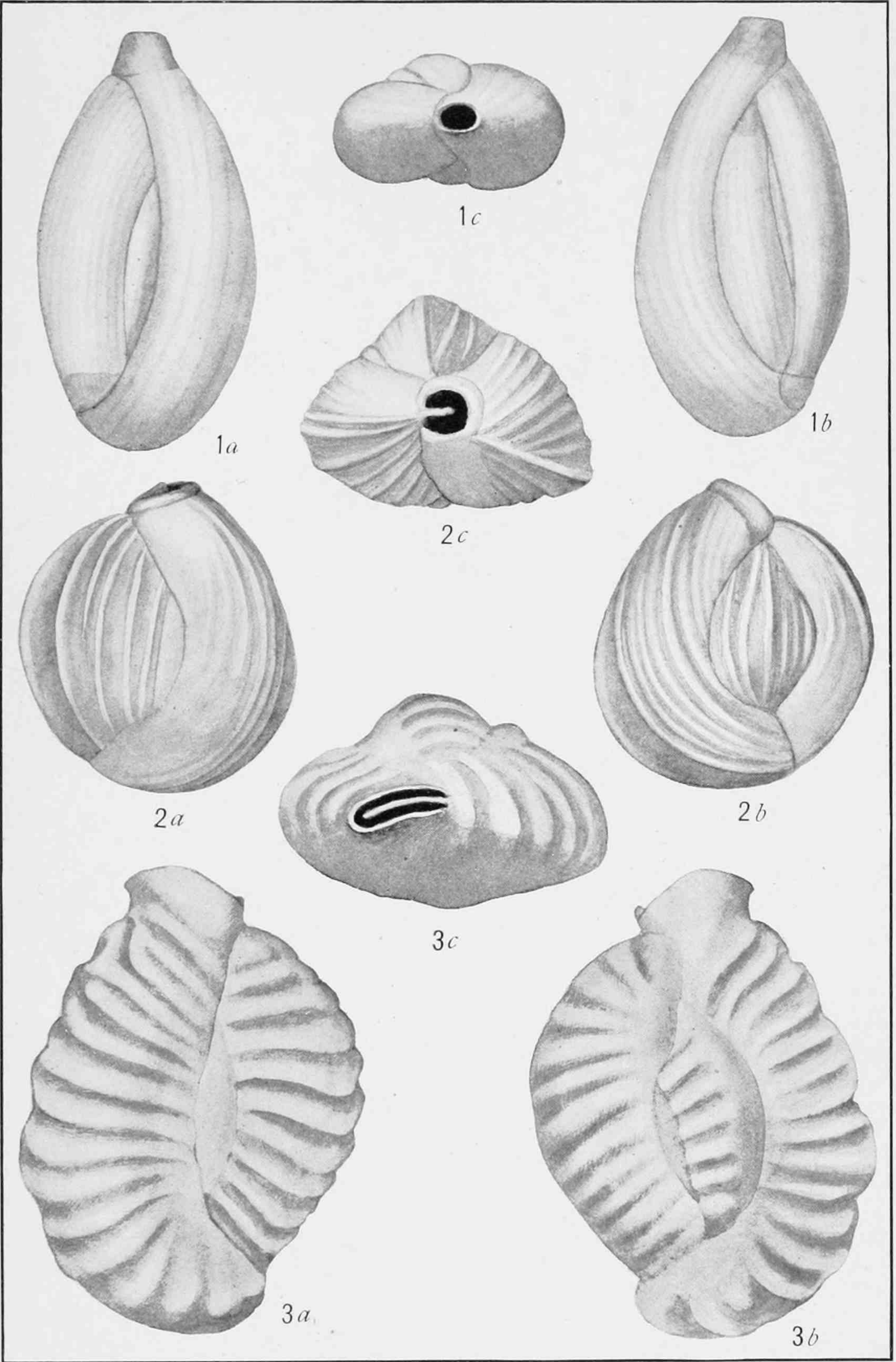

MILIOLIDAE OF NORTH PACIFIC OCEAN.

FOR EXPLANATION OF PLATE SEE PAGE 100.

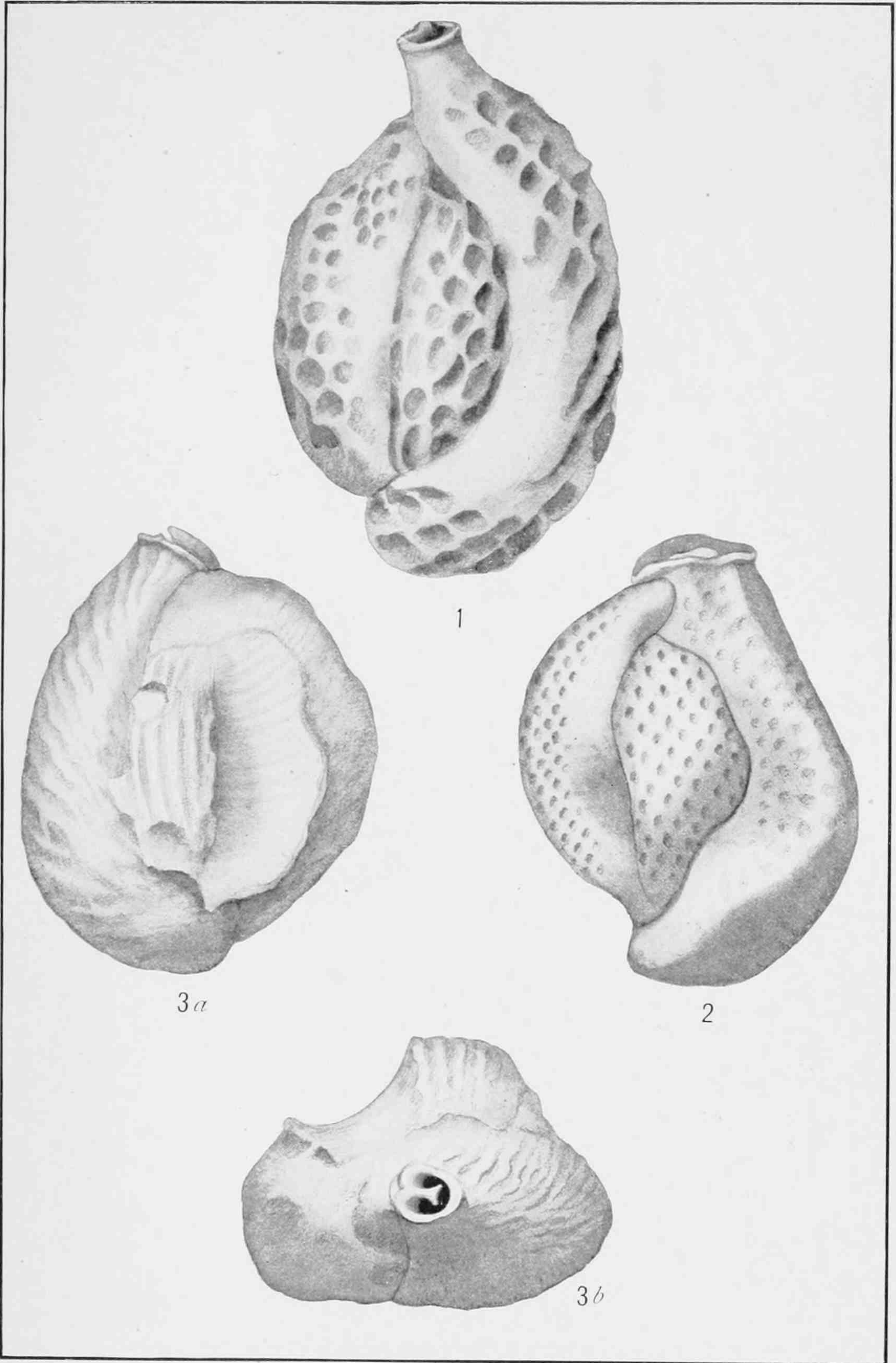

MILIOLIDAE OF NORTH PACIFIC OCEAN.

FOR EXPLANATION OF PLATE SEE PAGE 101.

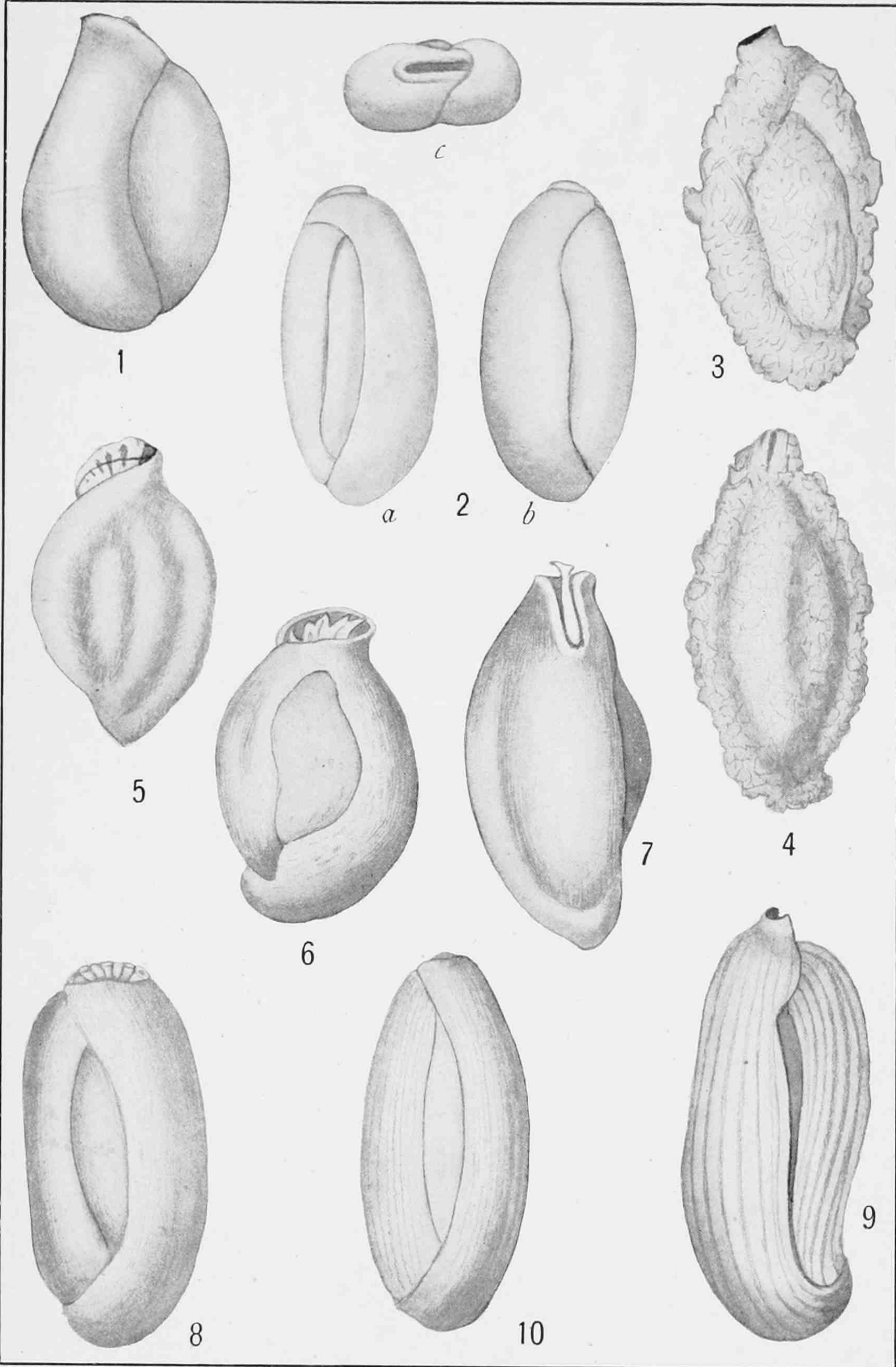

MILIOLIDAE OF NORTH PACIFIC OCEAN.

FOR EXPLANATION OF PLATE SEE PAGE 101.

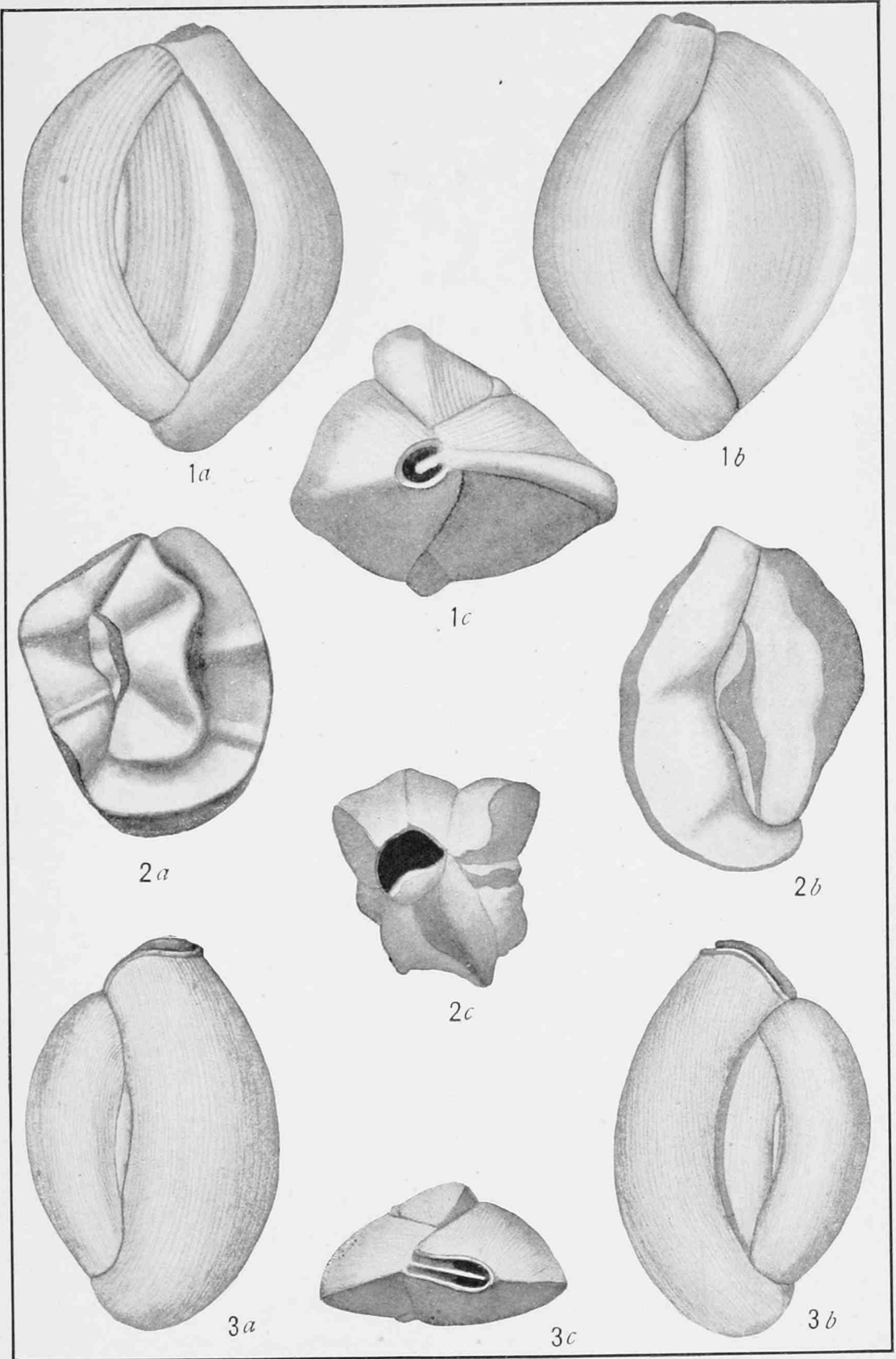

MILIOLIDAE OF NORTH PACIFIC OCEAN.

FOR EXPLANATION OF PLATE SEE PAGE 101.

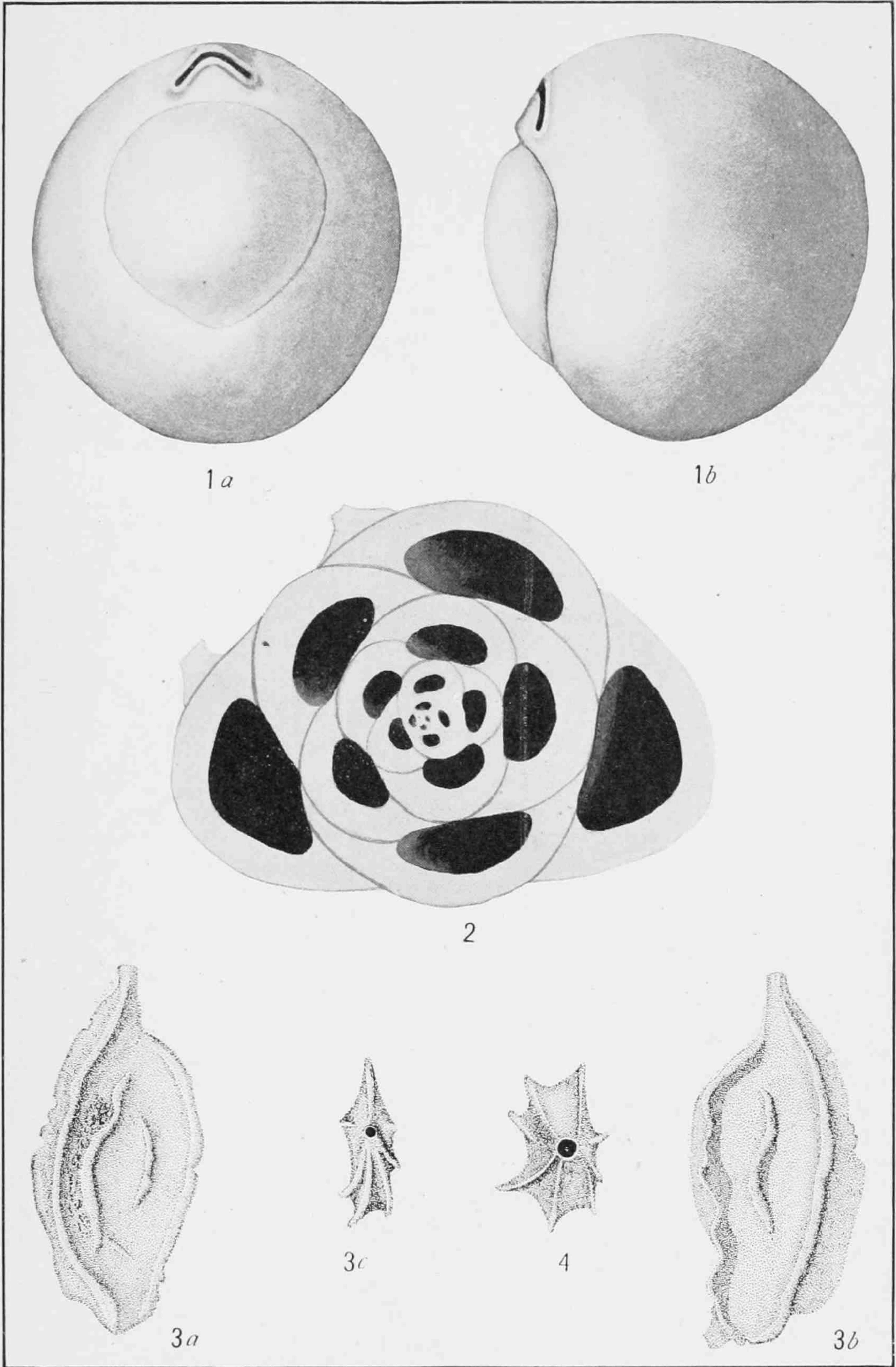

MILIOLIDAE OF NORTH PACIFIC OCEAN.

FOR EXPLANATION OF PLATE SEE PAGE 101.



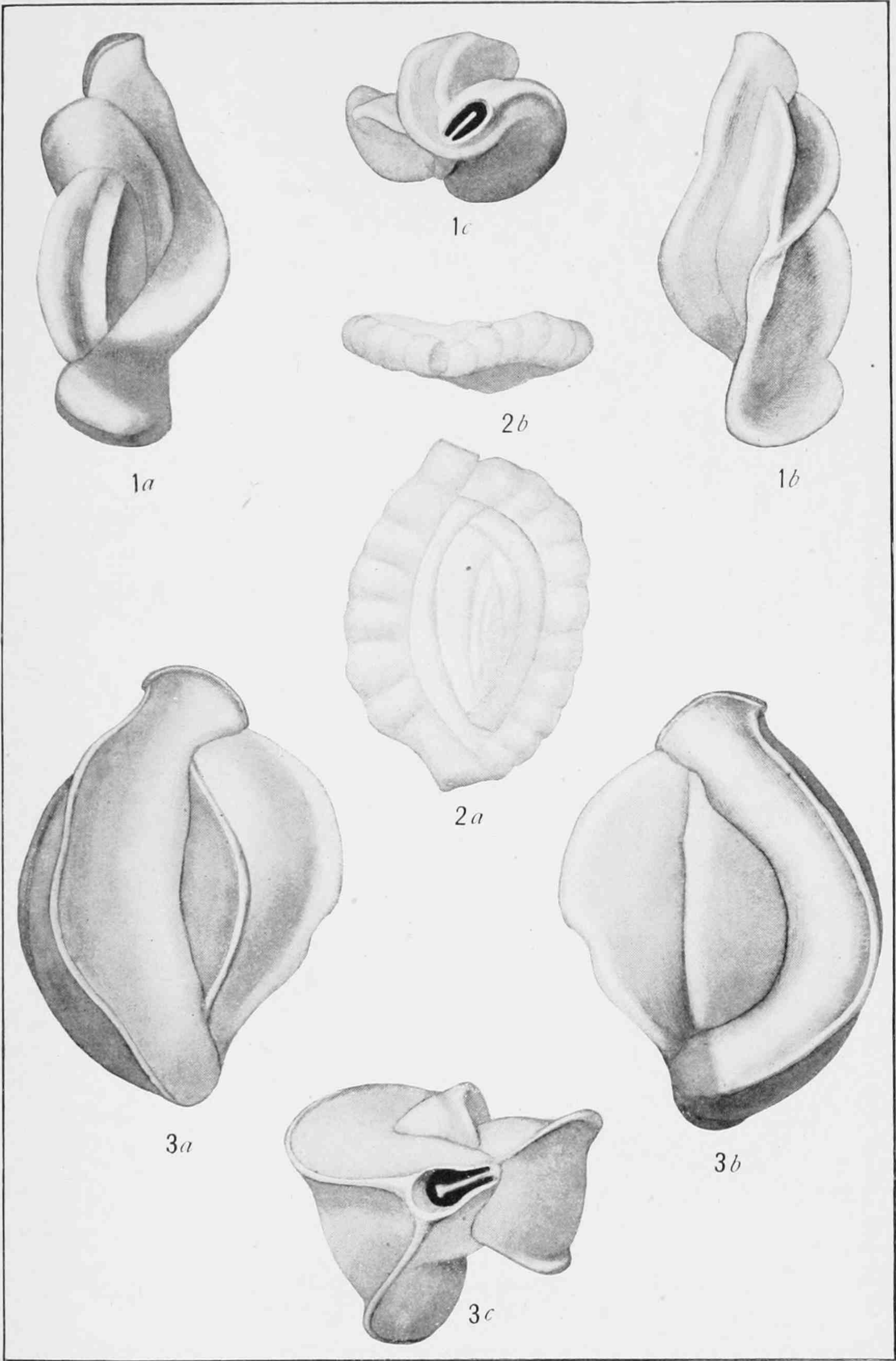

MILIOLIDAE OF NORTH PACIFIC OCEAN.

FOR EXPLANATION OF PLATE SEE PAGE 101.

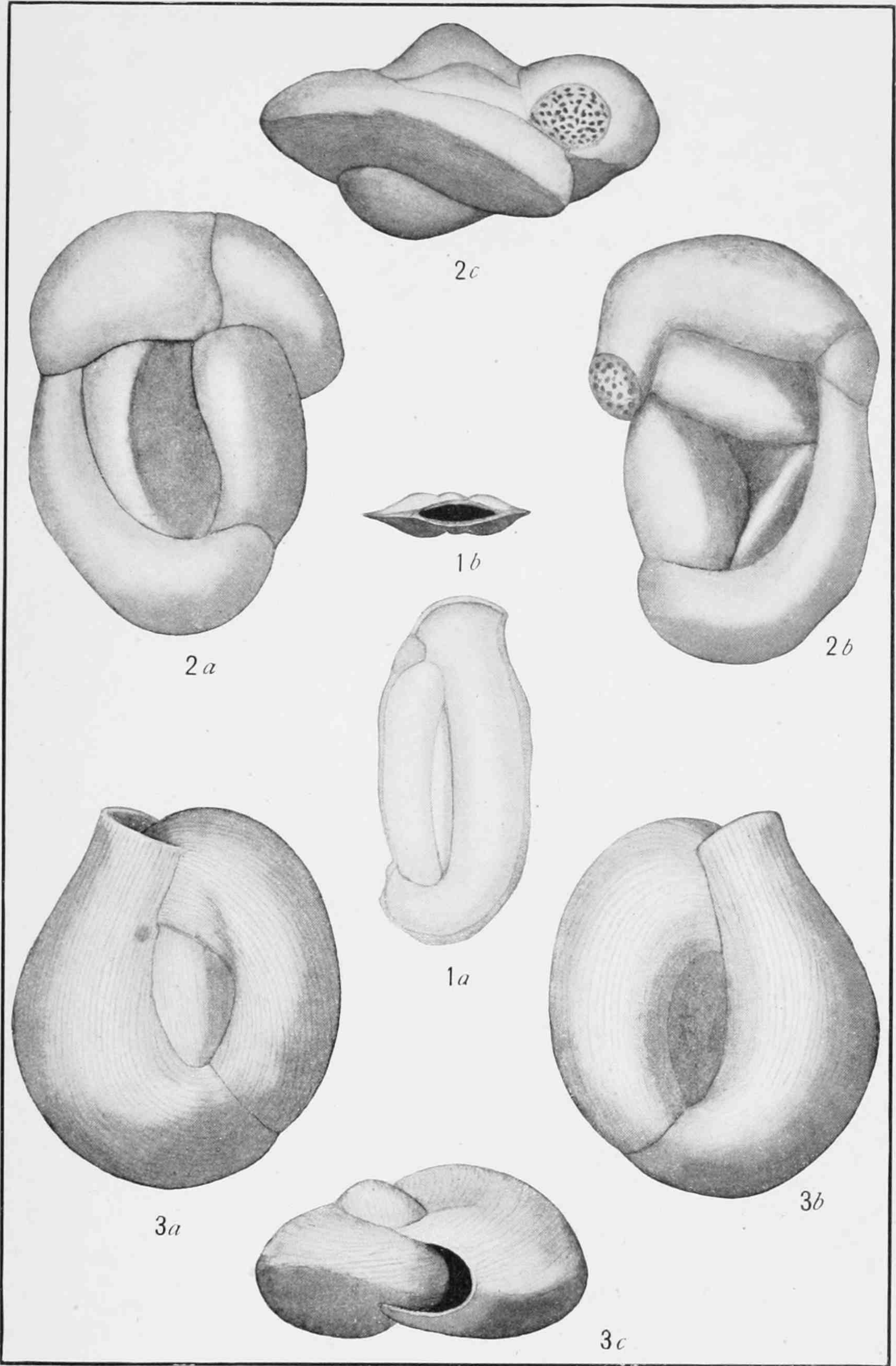

MILIOLIDAE OF NORTH PACIFIC OCEAN.

FOR EXPLANATION OF PLATE SEE PAGE 101.

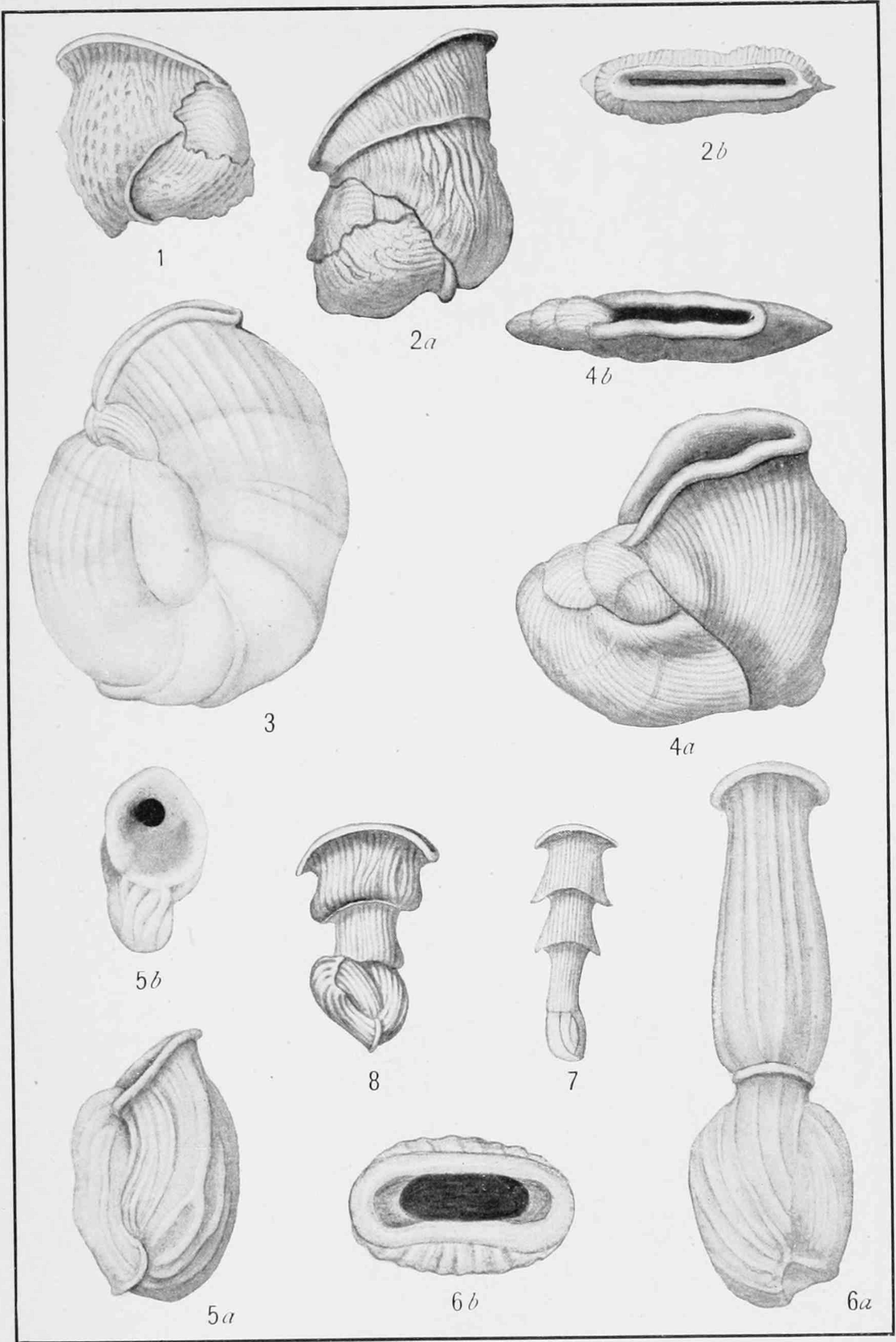

MILIOLIDAE OF NORTH PACIFIC OCEAN.

FOR EXPLANATION OF PLATE SEE PAGE 101.

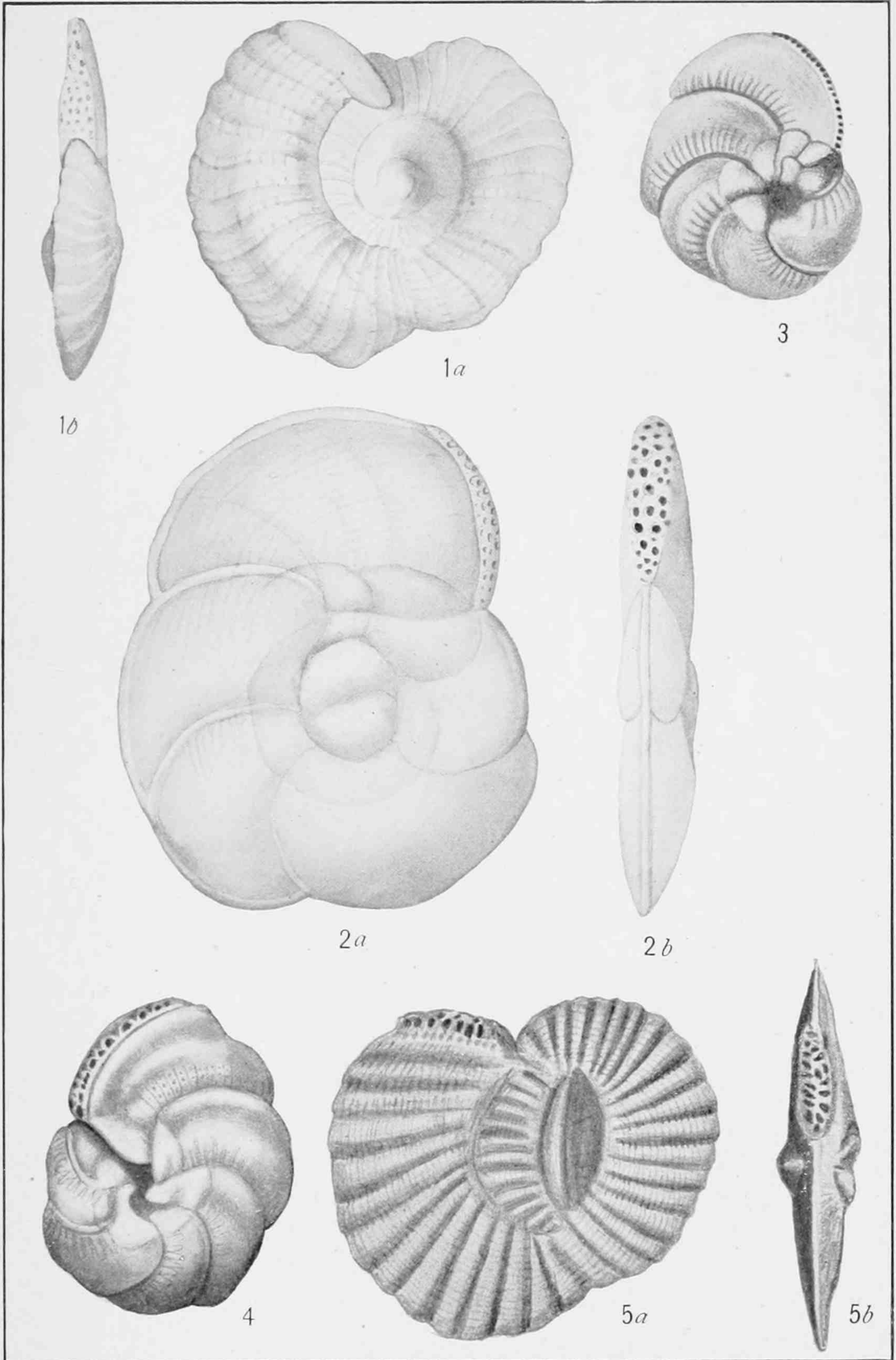

MILIOLIDAE OF NORTH PACIFIC OCEAN.

FOR EXPLANATION OF PLATE SEE PAGE 102.

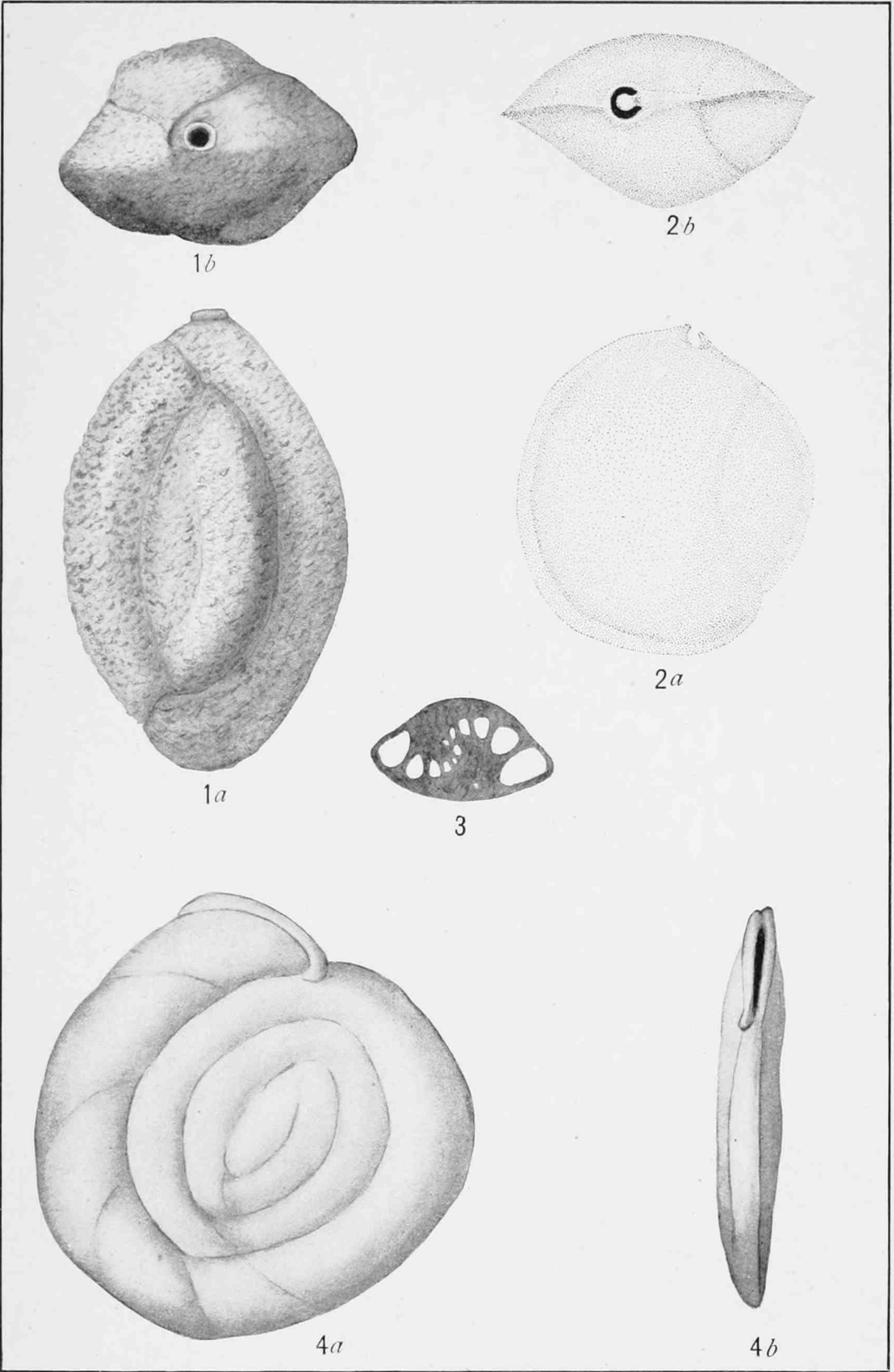

MILIOLIDAE OF NORTH PACIFIC OCEAN.

FOR EXPLANATION OF PLATE SEE PAGE 102.

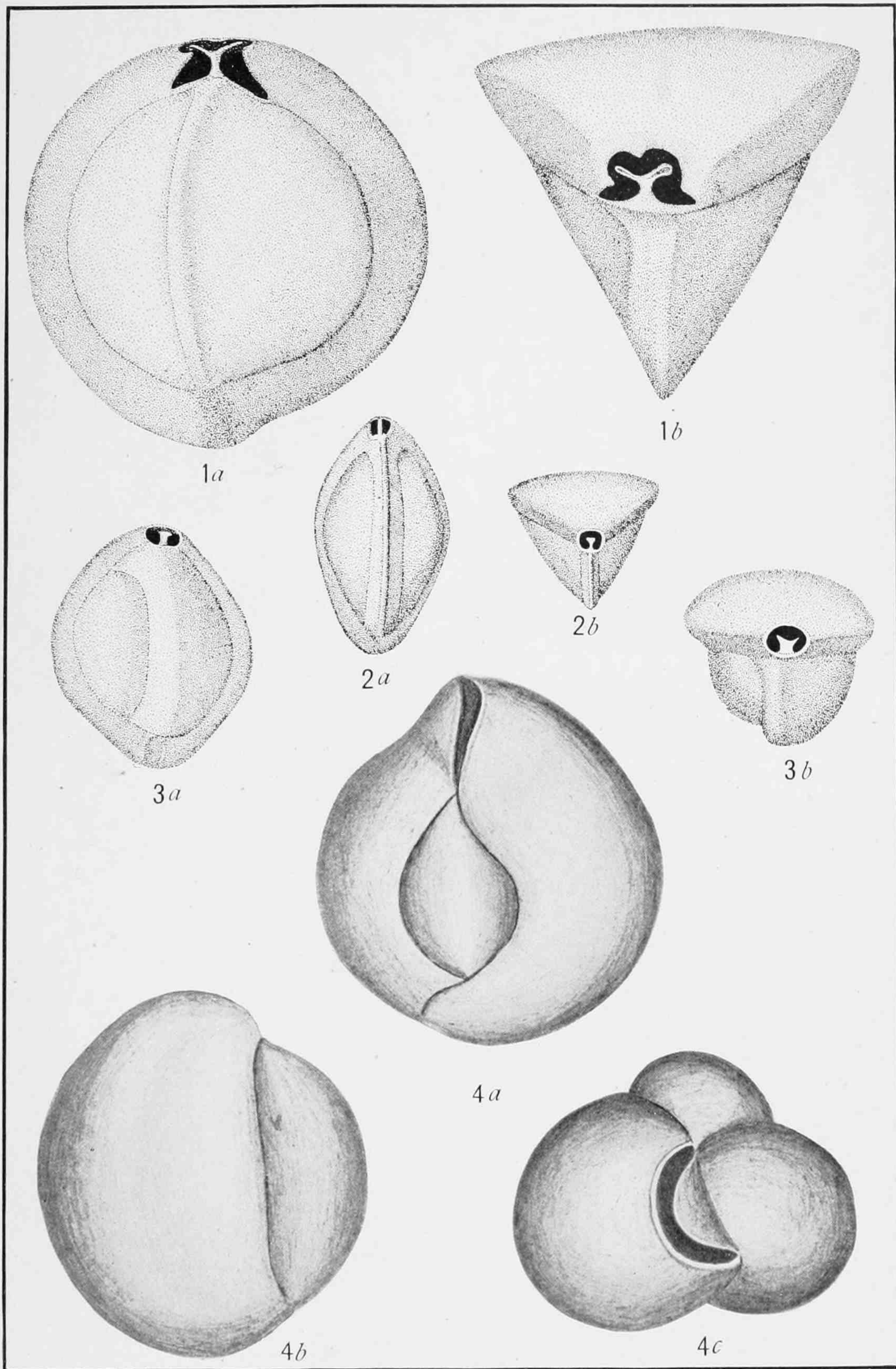

MILIOLIDAE OF NORTH PACIFIC OCEAN.

FOR EXPLANATION OF PLATE SEE PAGE 102.

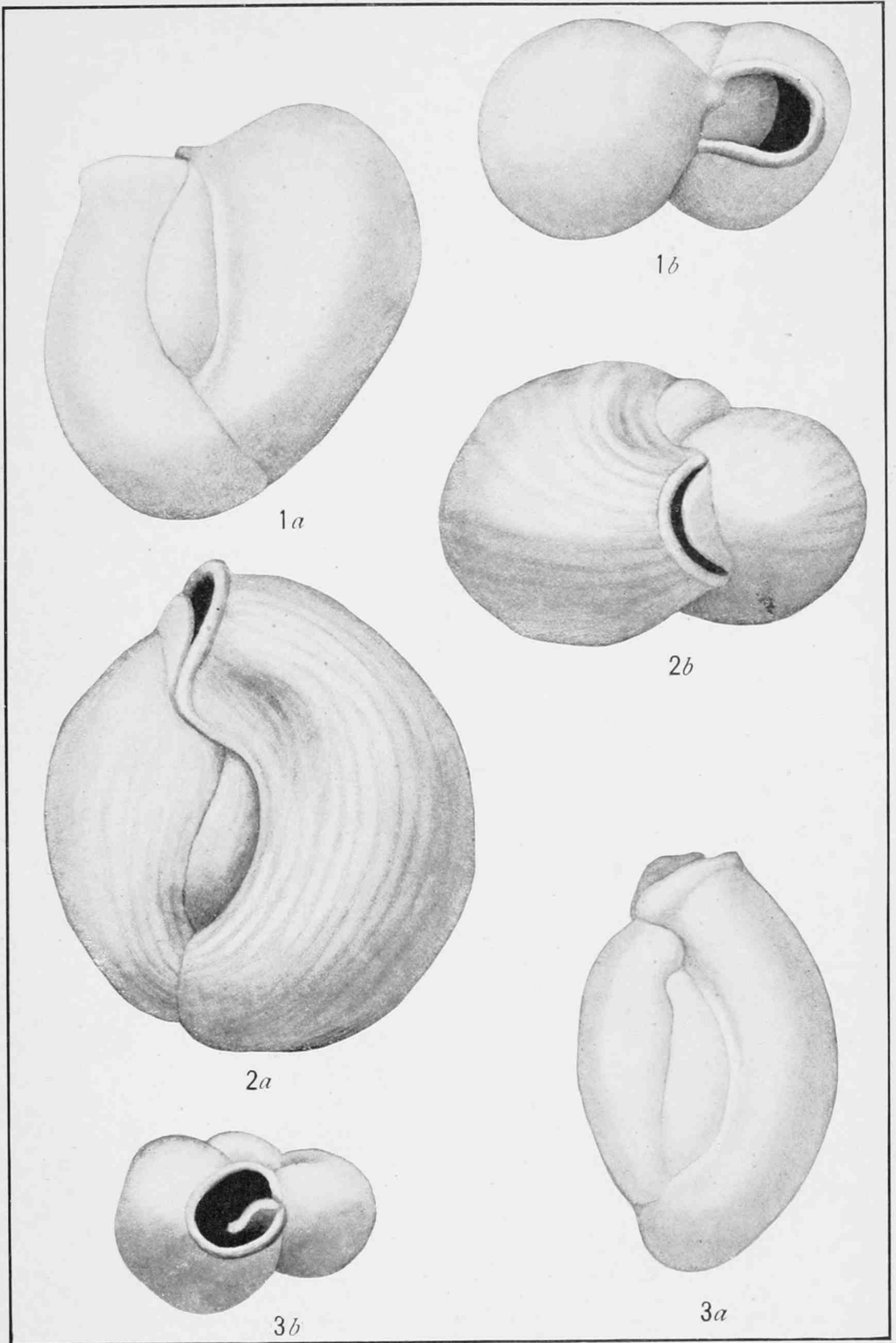

MILIOLIDAE OF NORTH PACIFIC OCEAN.

FOR EXPLANATION OF PLATE SEE PAGE 102.

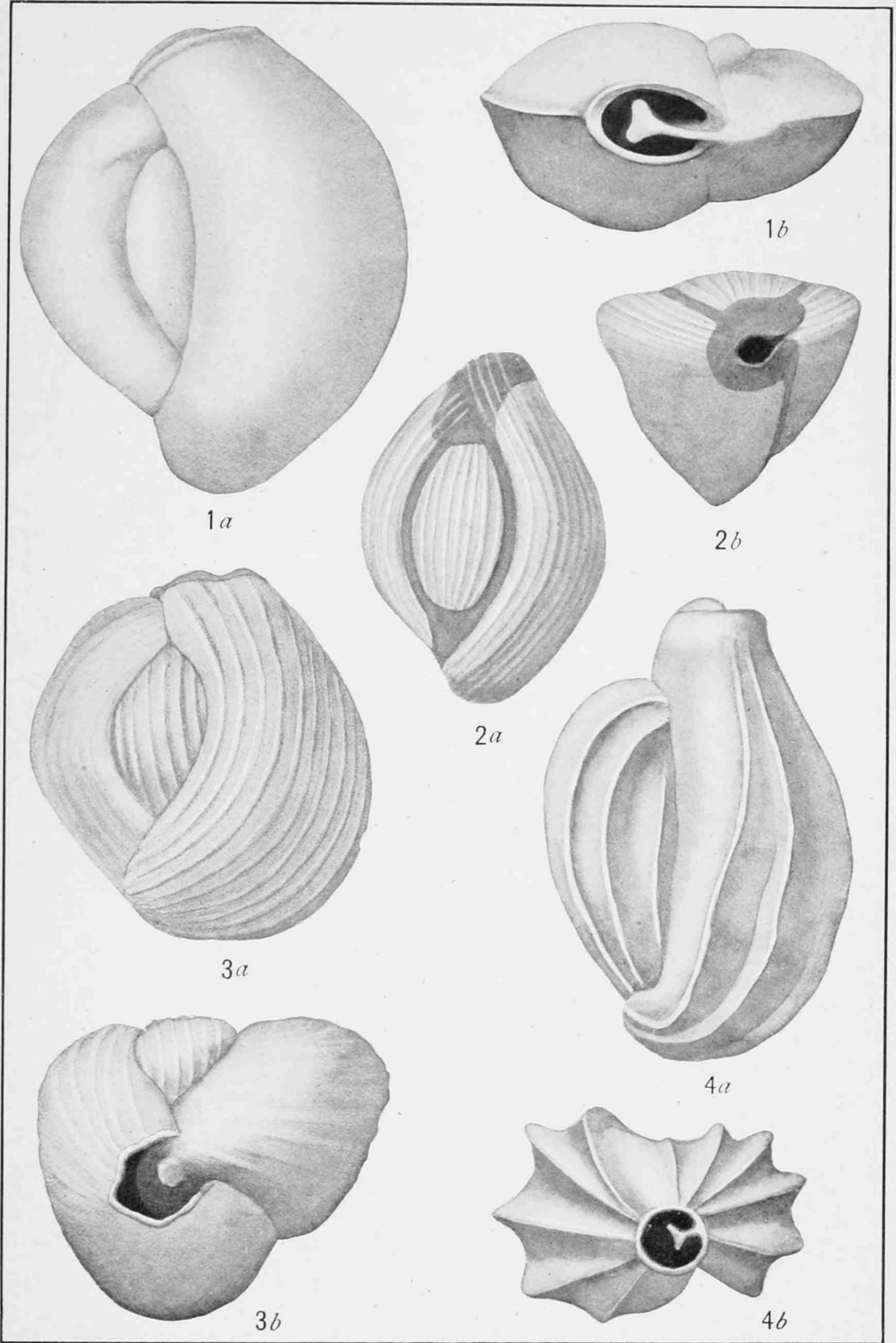

MILIOLIDAE OF NORTH PACIFIC OCEAN.

FOR EXPLANATION OF PLATE SEE PAGE 102.



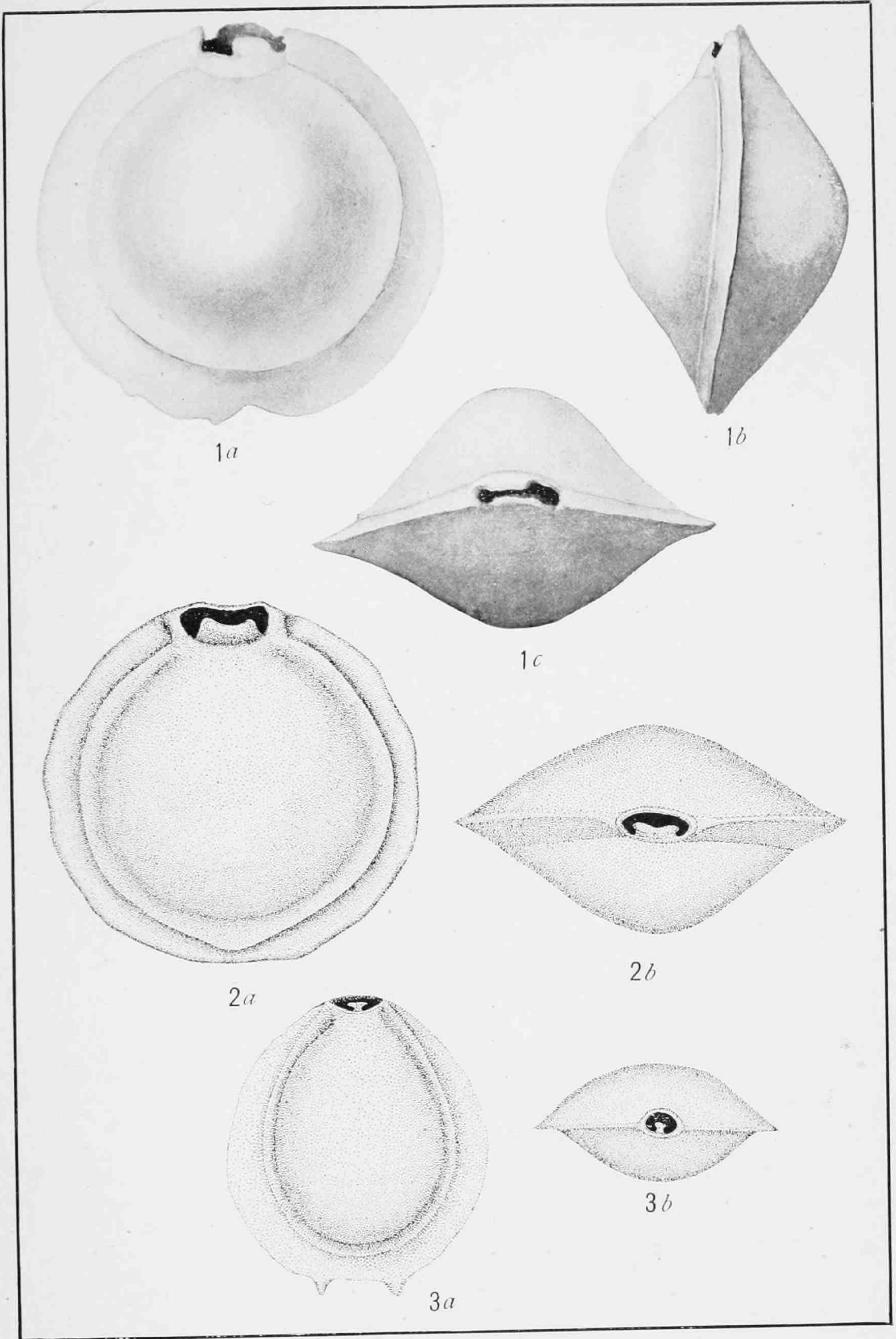

MILIOLIDAE OF NORTH PACIFIC OCEAN.

FOR EXPLANATION OF PLATE SEE PAGE 102.

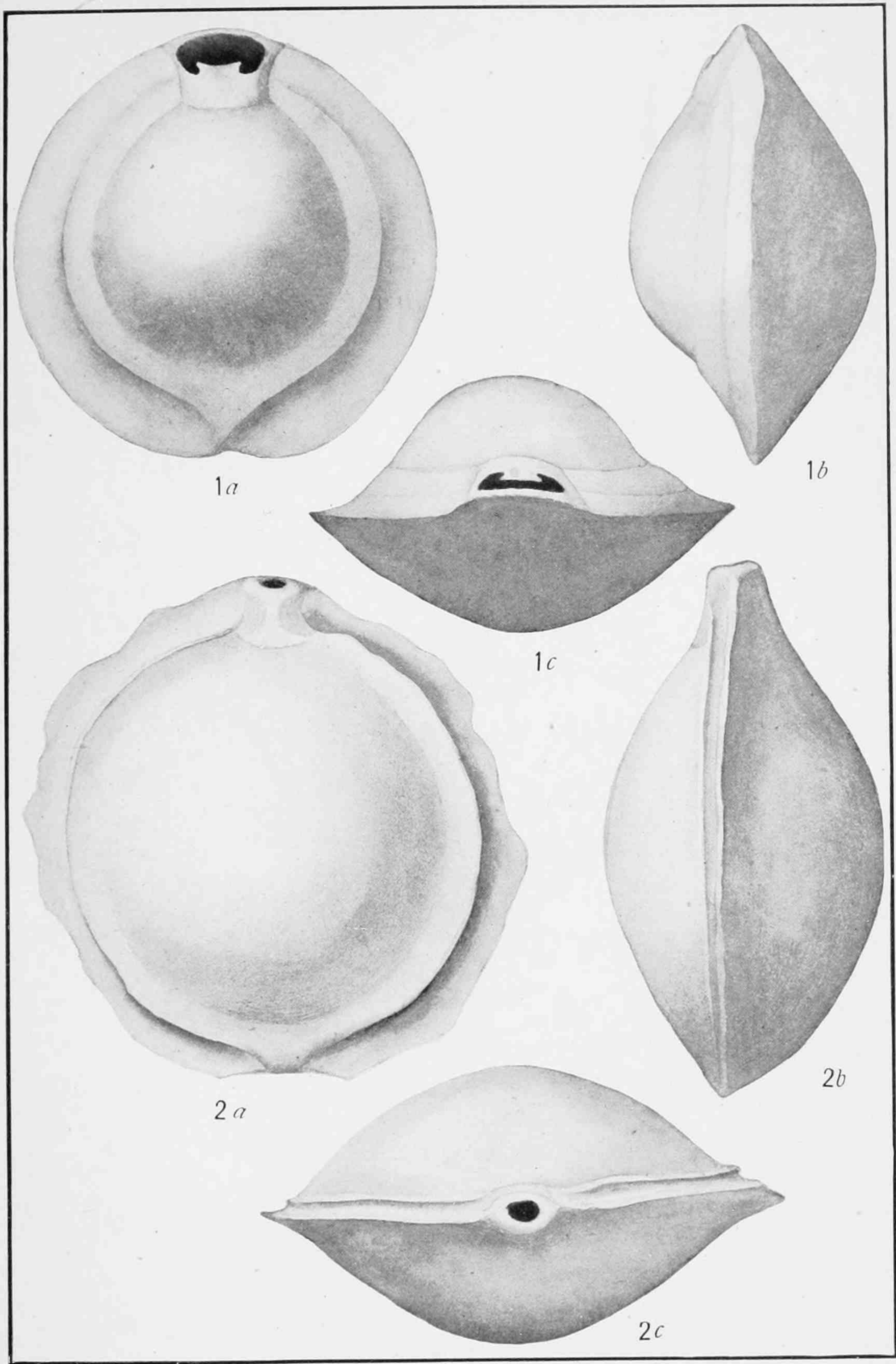

MILIOLIDAE OF NORTH PACIFIC OCEAN.

FOR EXPLANATION OF PLATE SEE PAGE 102.

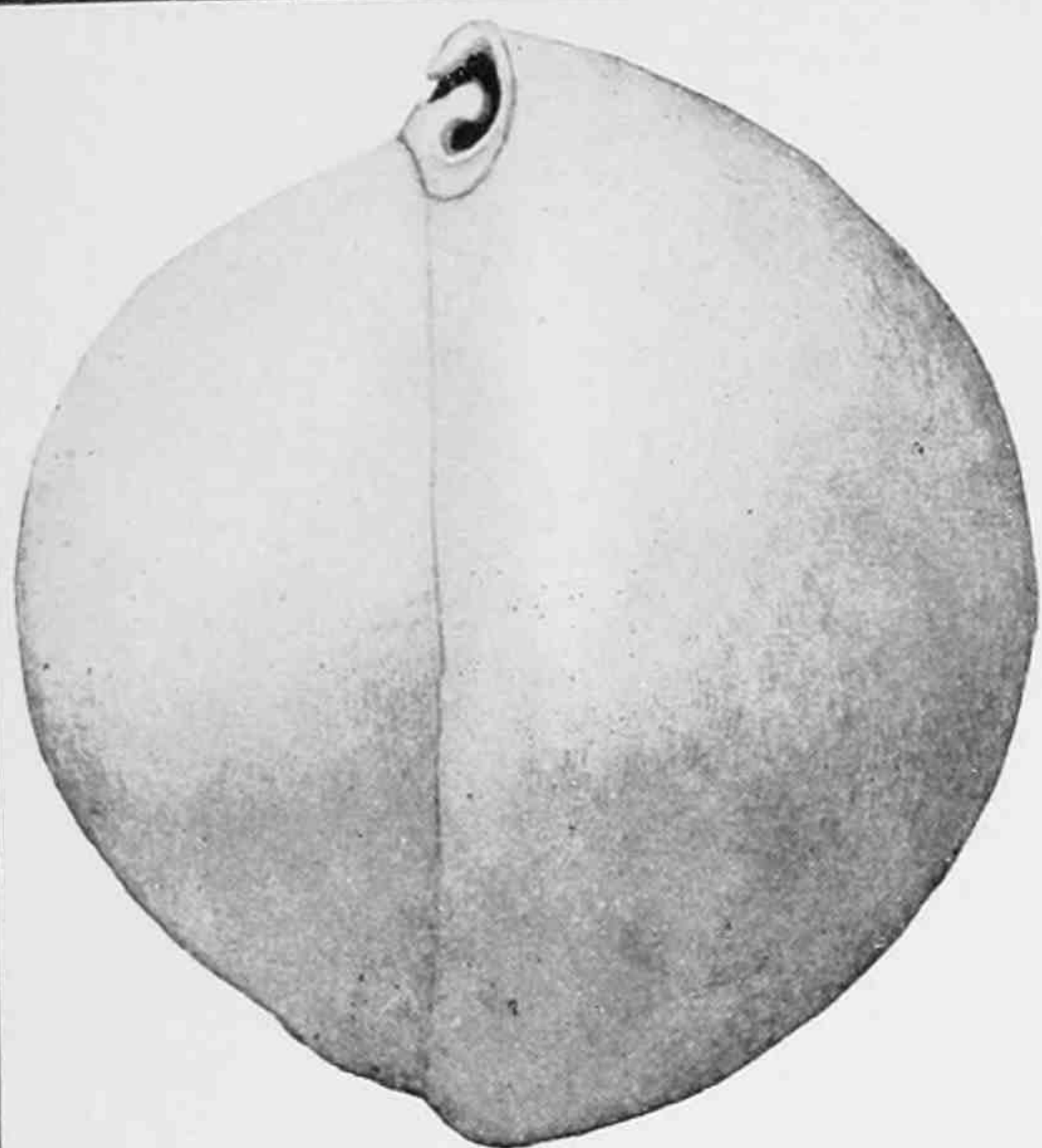

1b

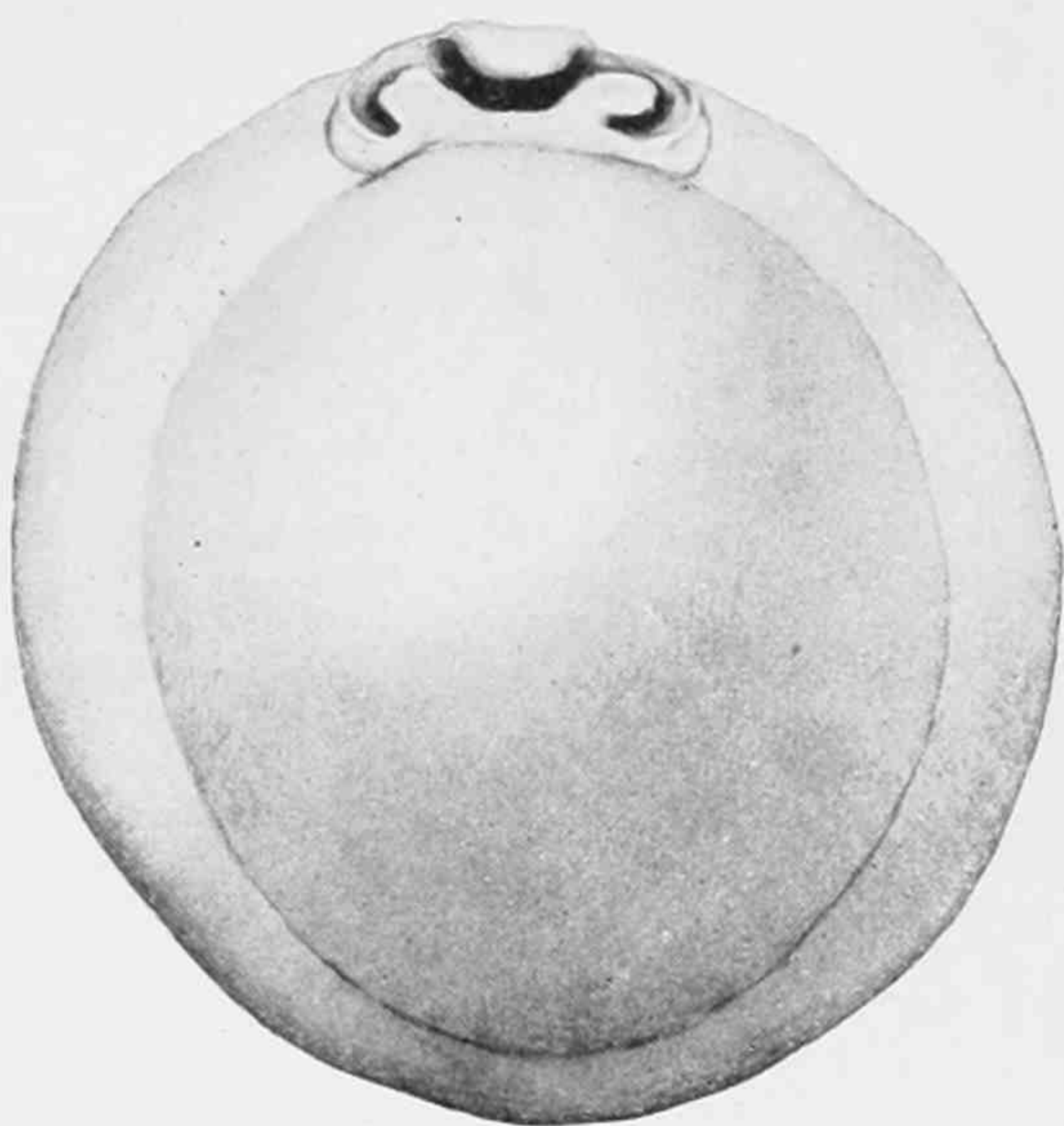

1a

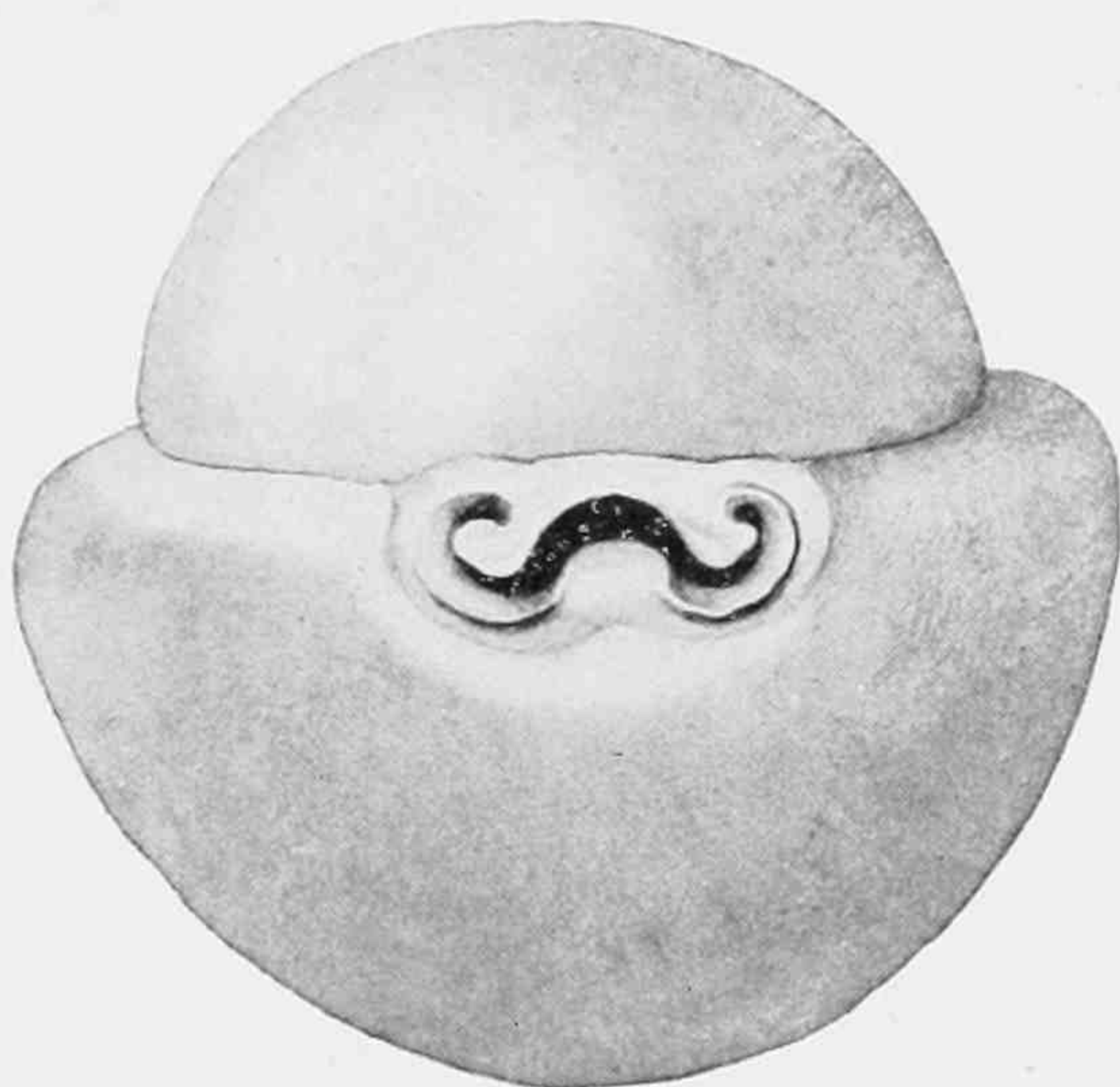

1c

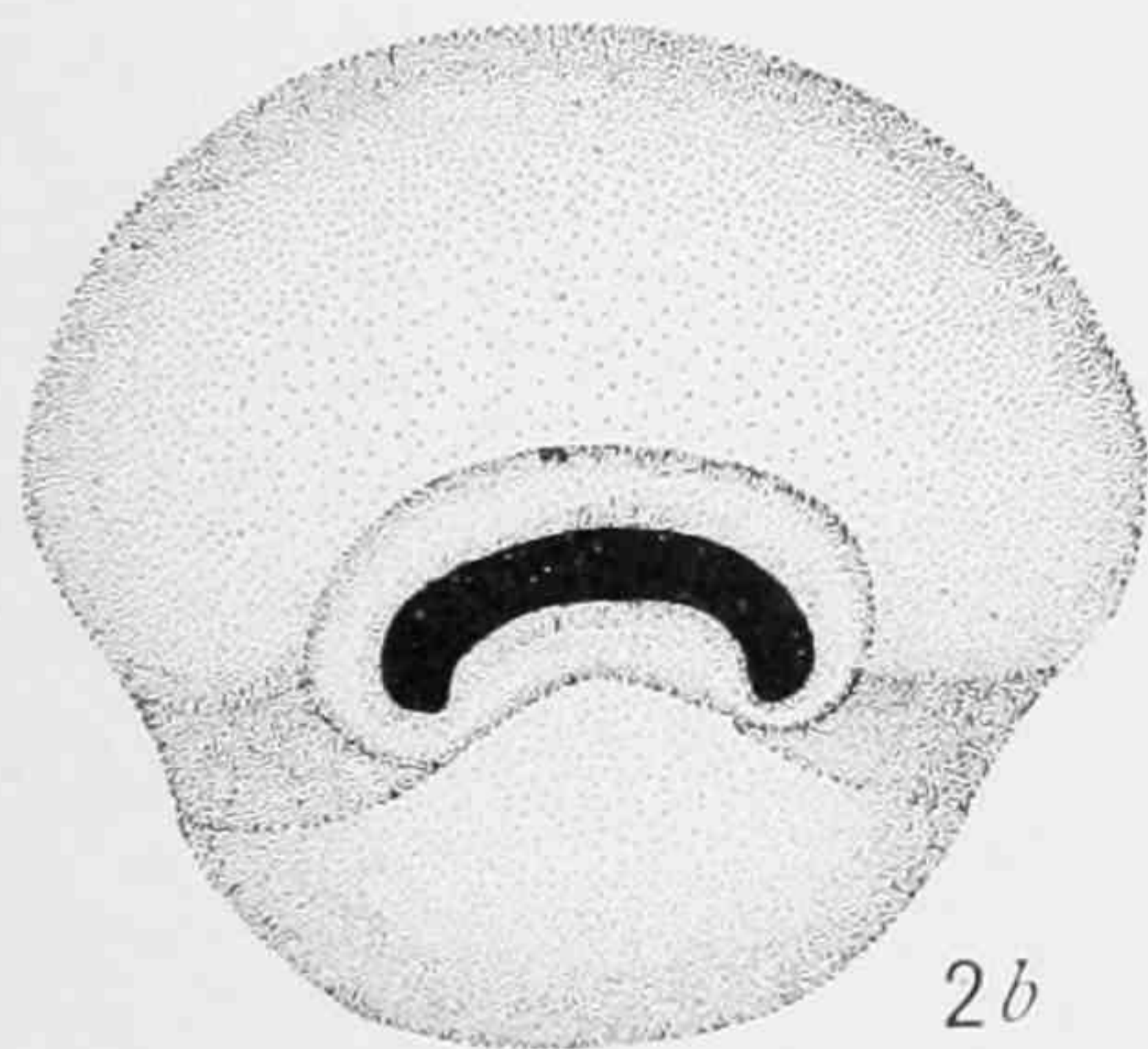

2b

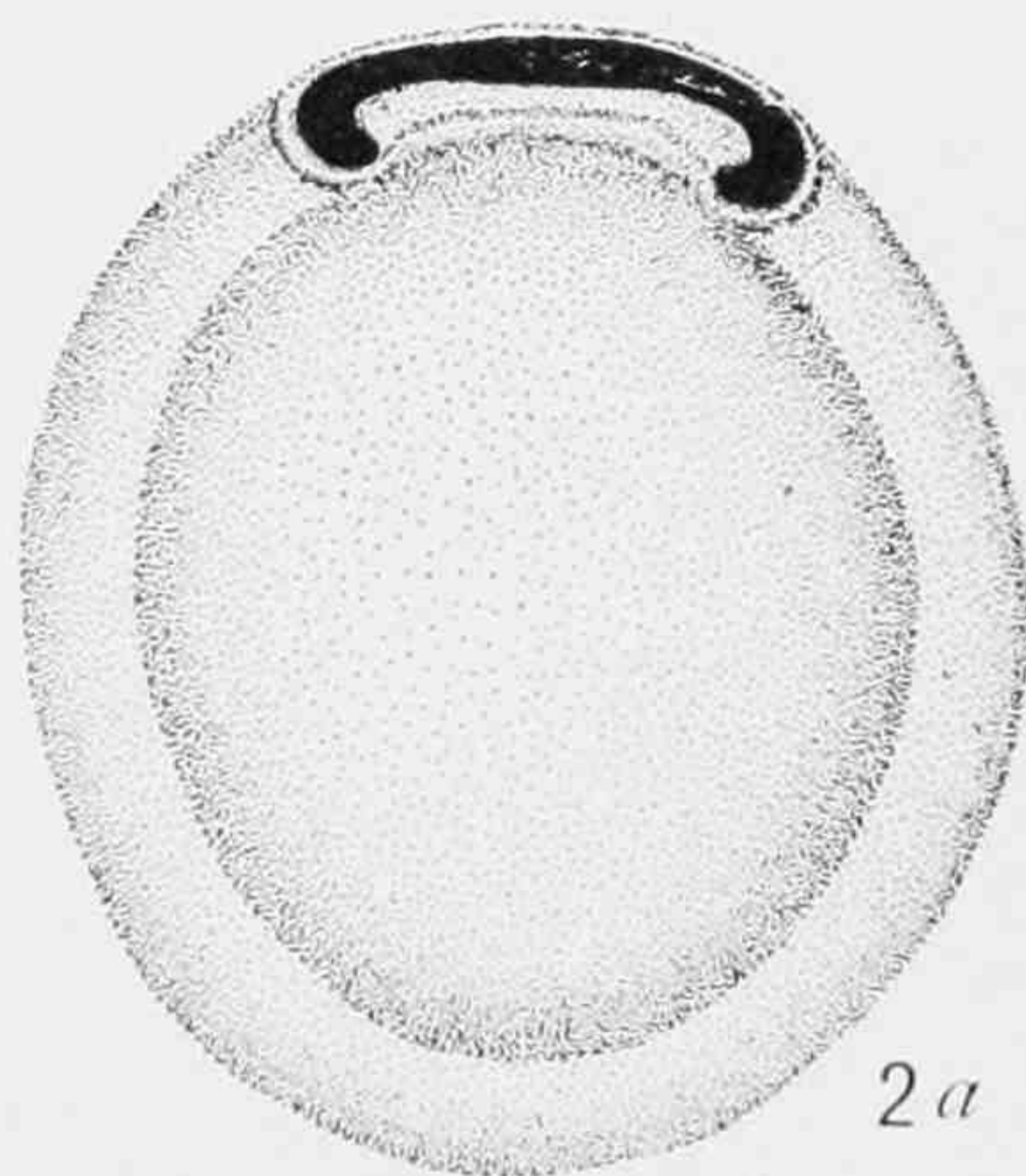

2a

MILIOLIDAE OF NORTH PACIFIC OCEAN.

FOR EXPLANATION OF PLATE SEE PAGE 102.

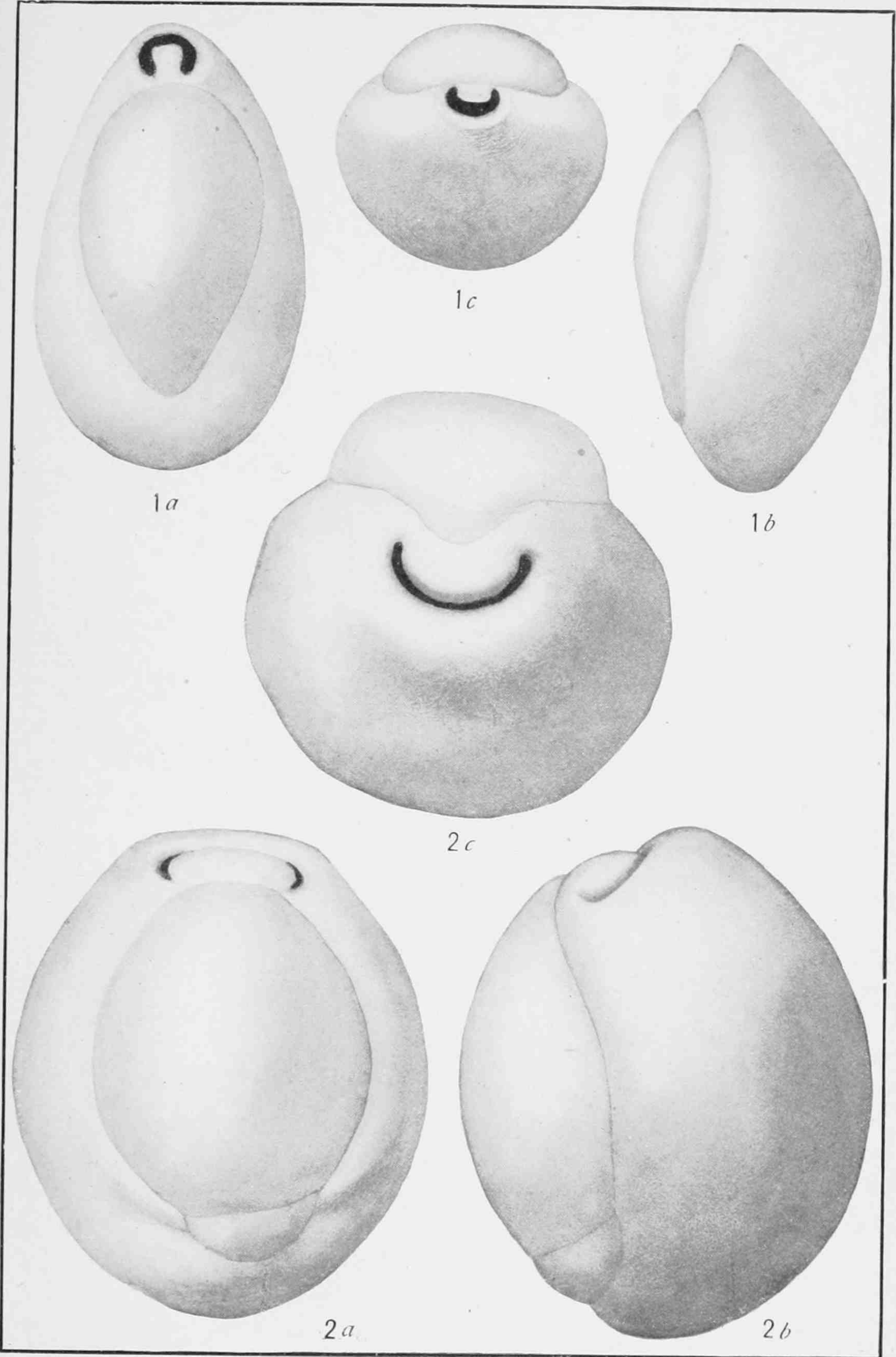

MILIOLIDAE OF NORTH PACIFIC OCEAN.

FOR EXPLANATION OF PLATE SEE PAGE 102.

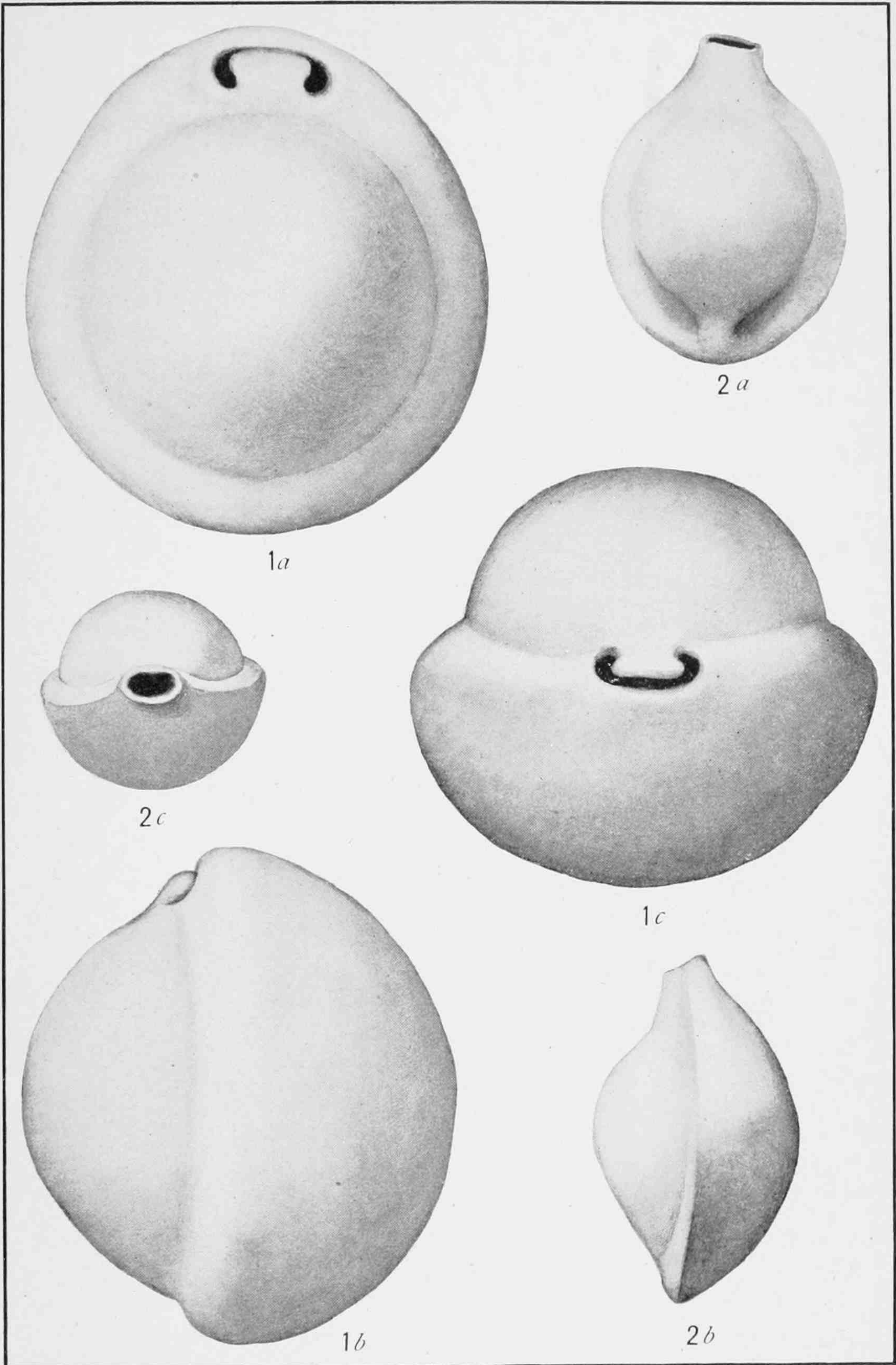

MILIOLIDAE OF NORTH PACIFIC OCEAN.

FOR EXPLANATION OF PLATE SEE PAGE 102.

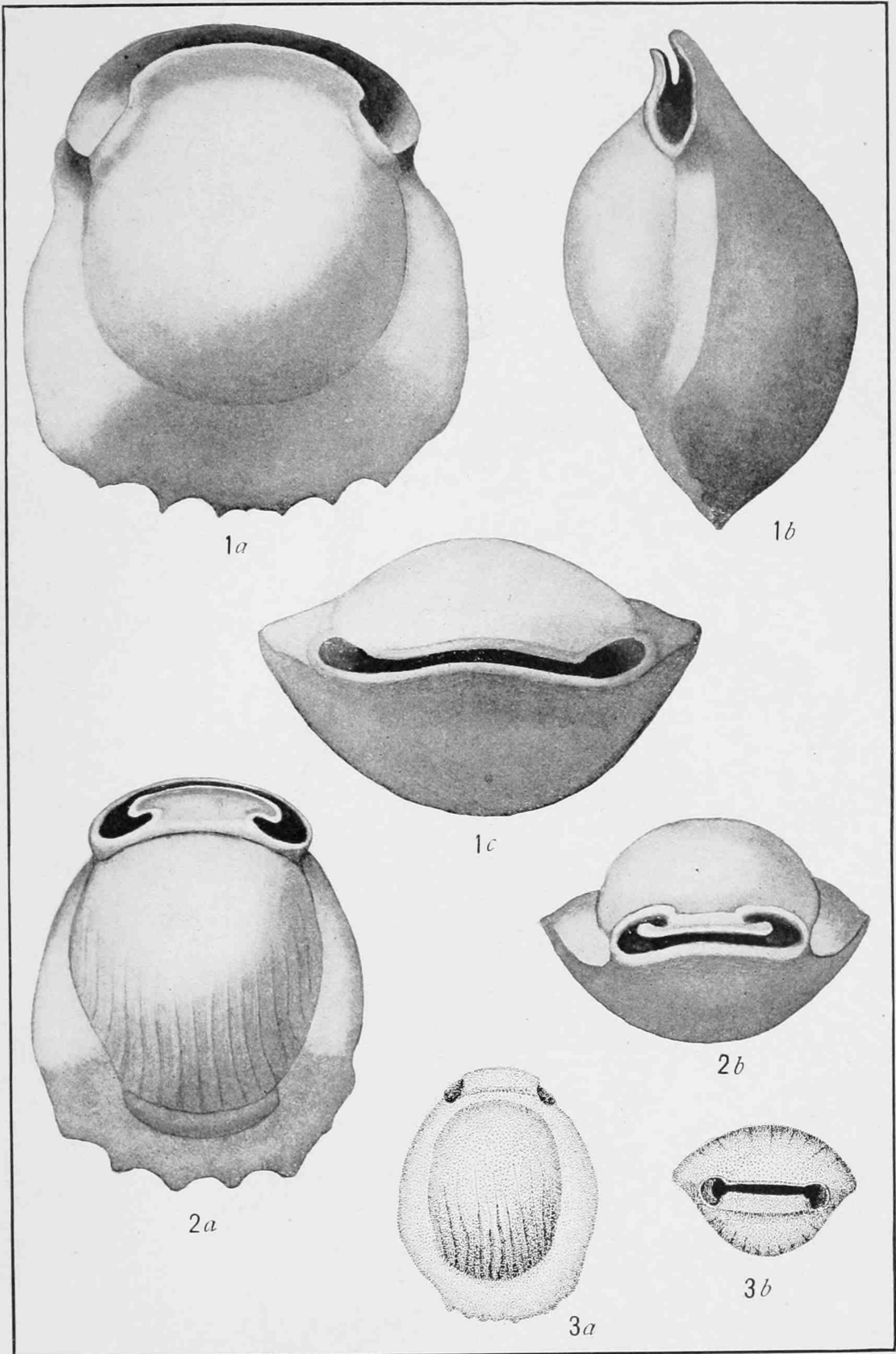

MILIOLIDAE OF NORTH PACIFIC OCEAN.

FOR EXPLANATION OF PLATE SEE PAGE 103.

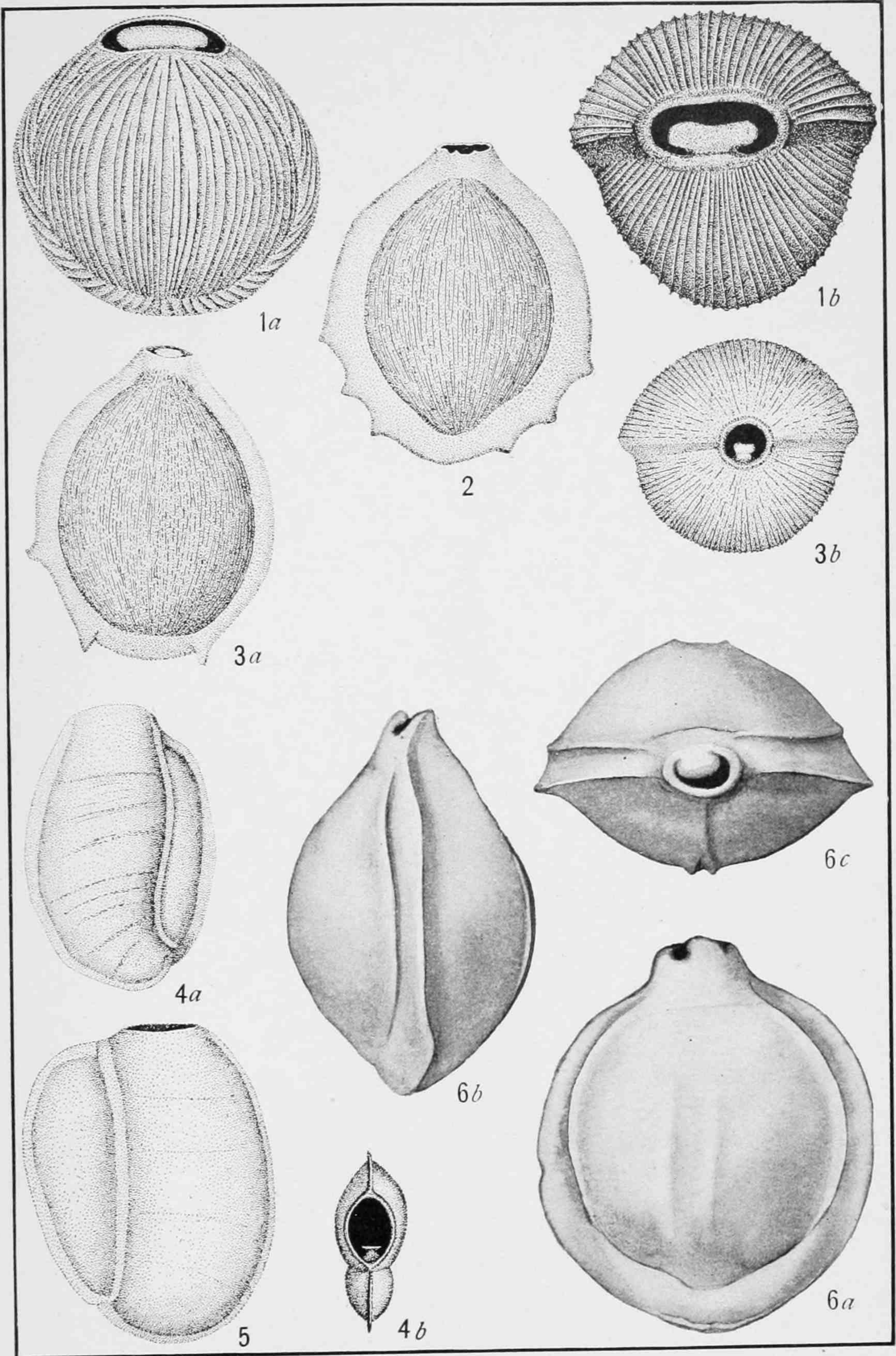

MILIOLIDAE OF NORTH PACIFIC OCEAN.

FOR EXPLANATION OF PLATE SEE PAGE 103.

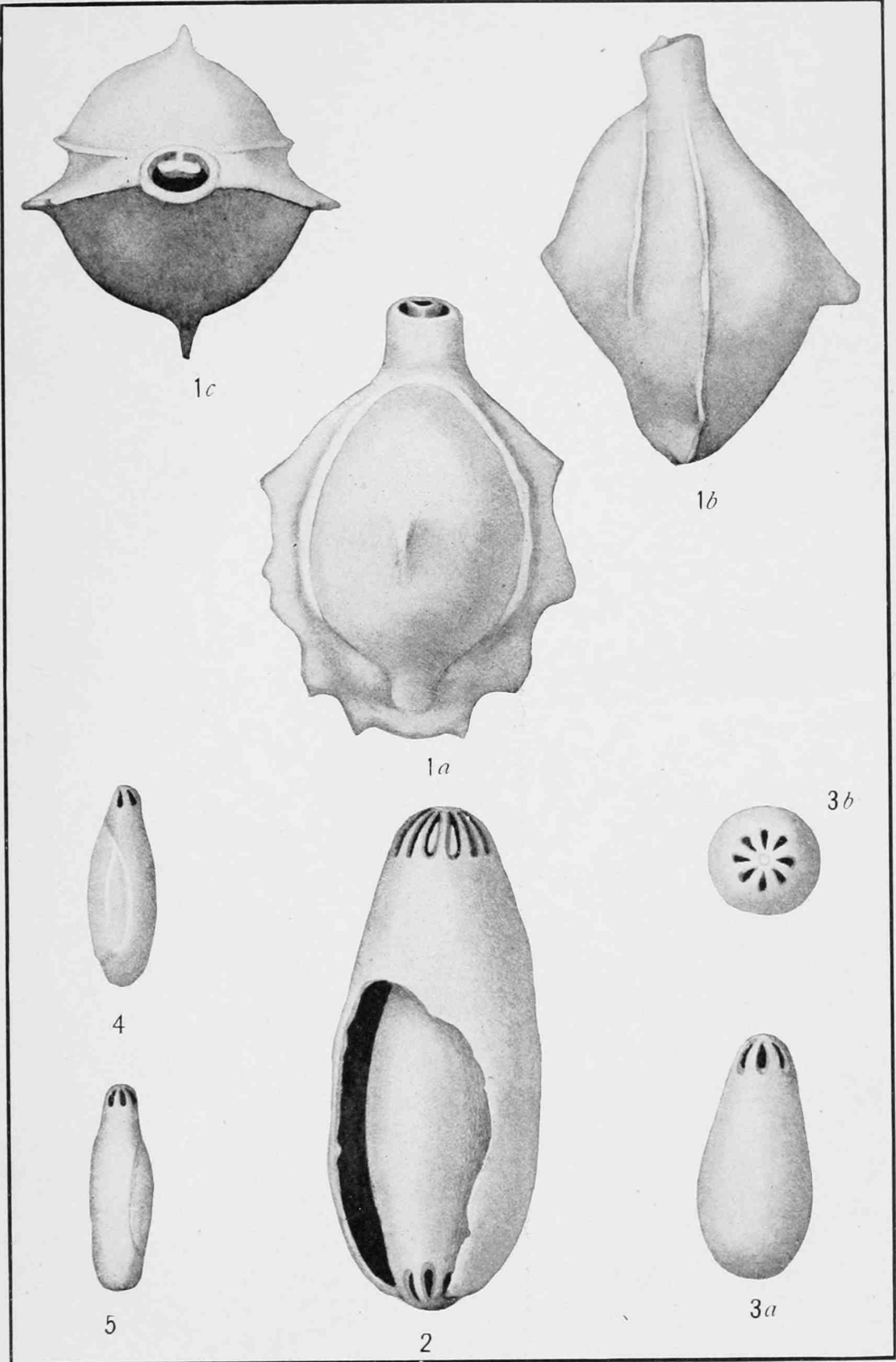

MILIOLIDAE OF NORTH PACIFIC OCEAN.

FOR EXPLANATION OF PLATE SEE PAGE 103.



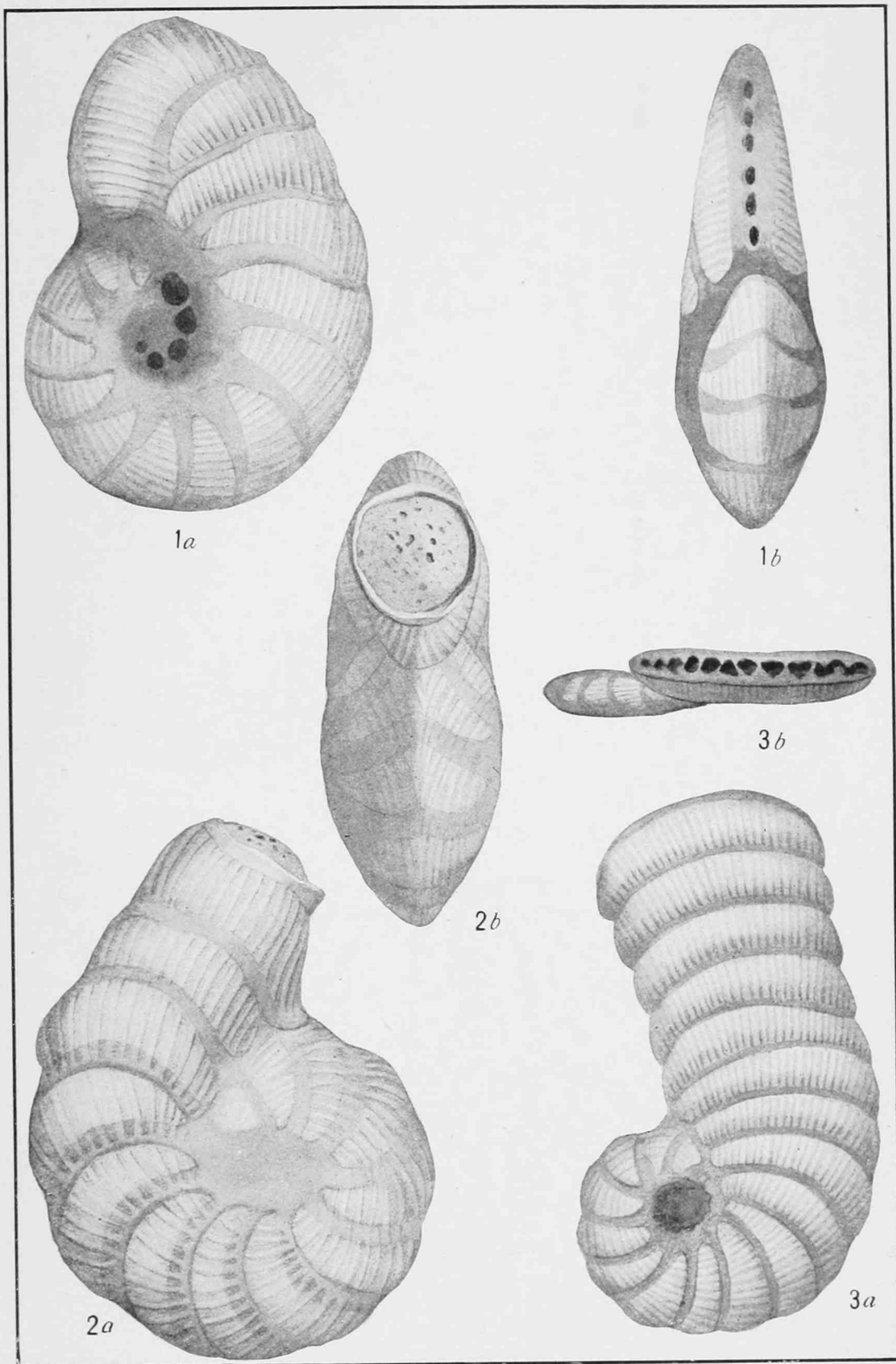

MILIOLIDAE OF NORTH PACIFIC OCEAN.

FOR EXPLANATION OF PLATE SEE PAGE 103.

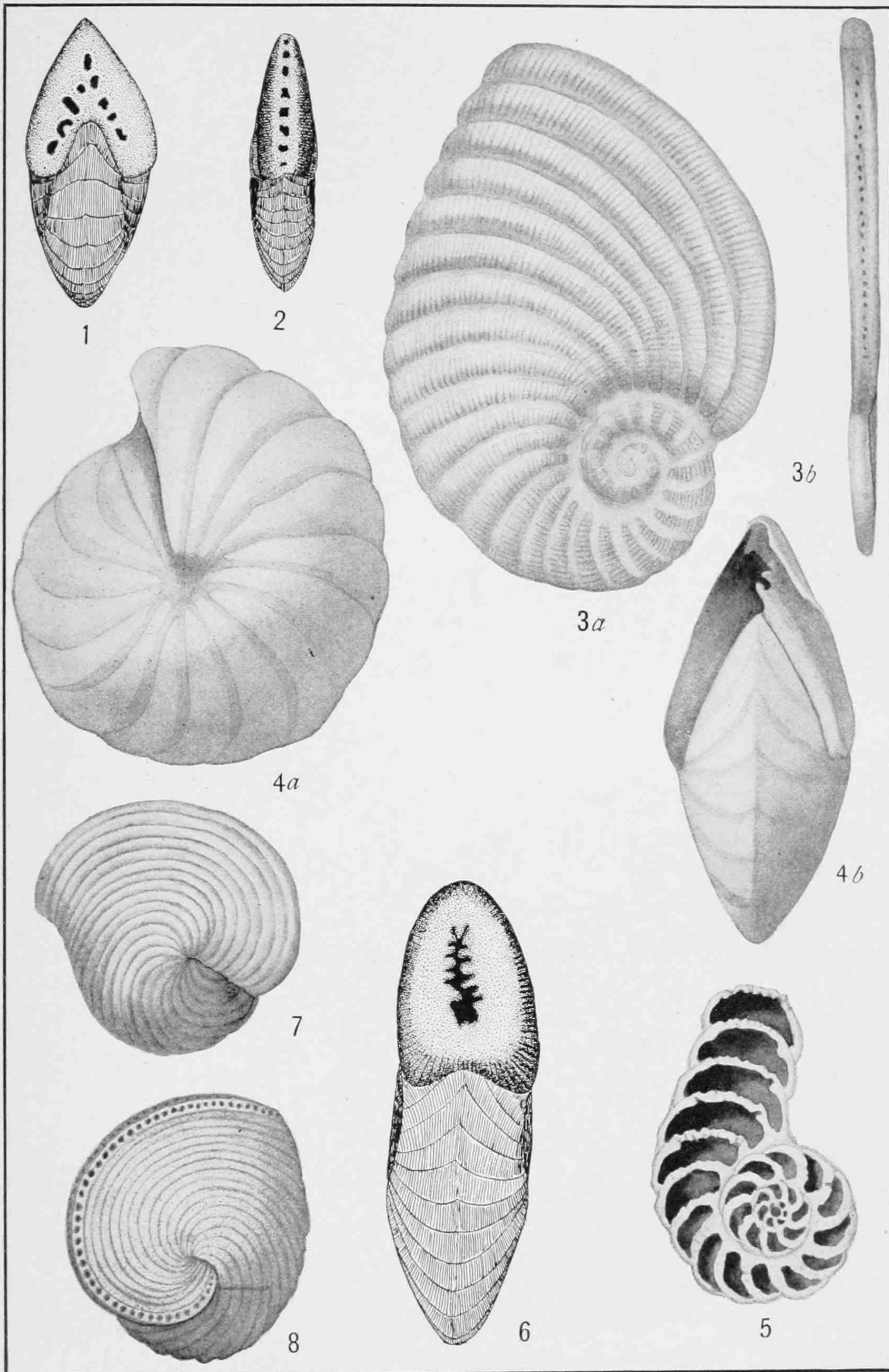

MILIOLIDAE OF NORTH PACIFIC OCEAN.

FOR EXPLANATION OF PLATE SEE PAGE 103.

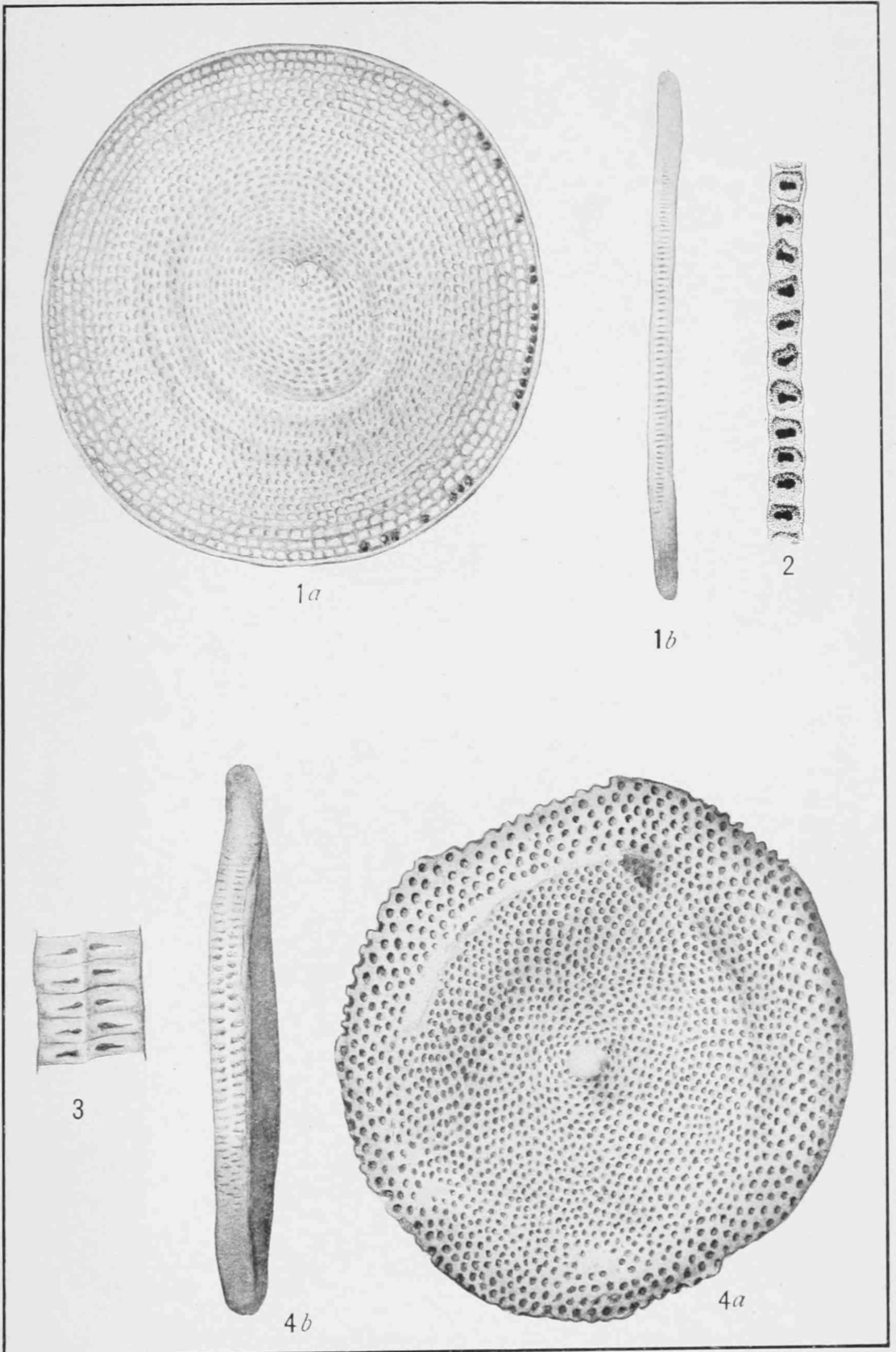

MILIOLIDAE OF NORTH PACIFIC OCEAN.

FOR EXPLANATION OF PLATE SEE PAGE 103.

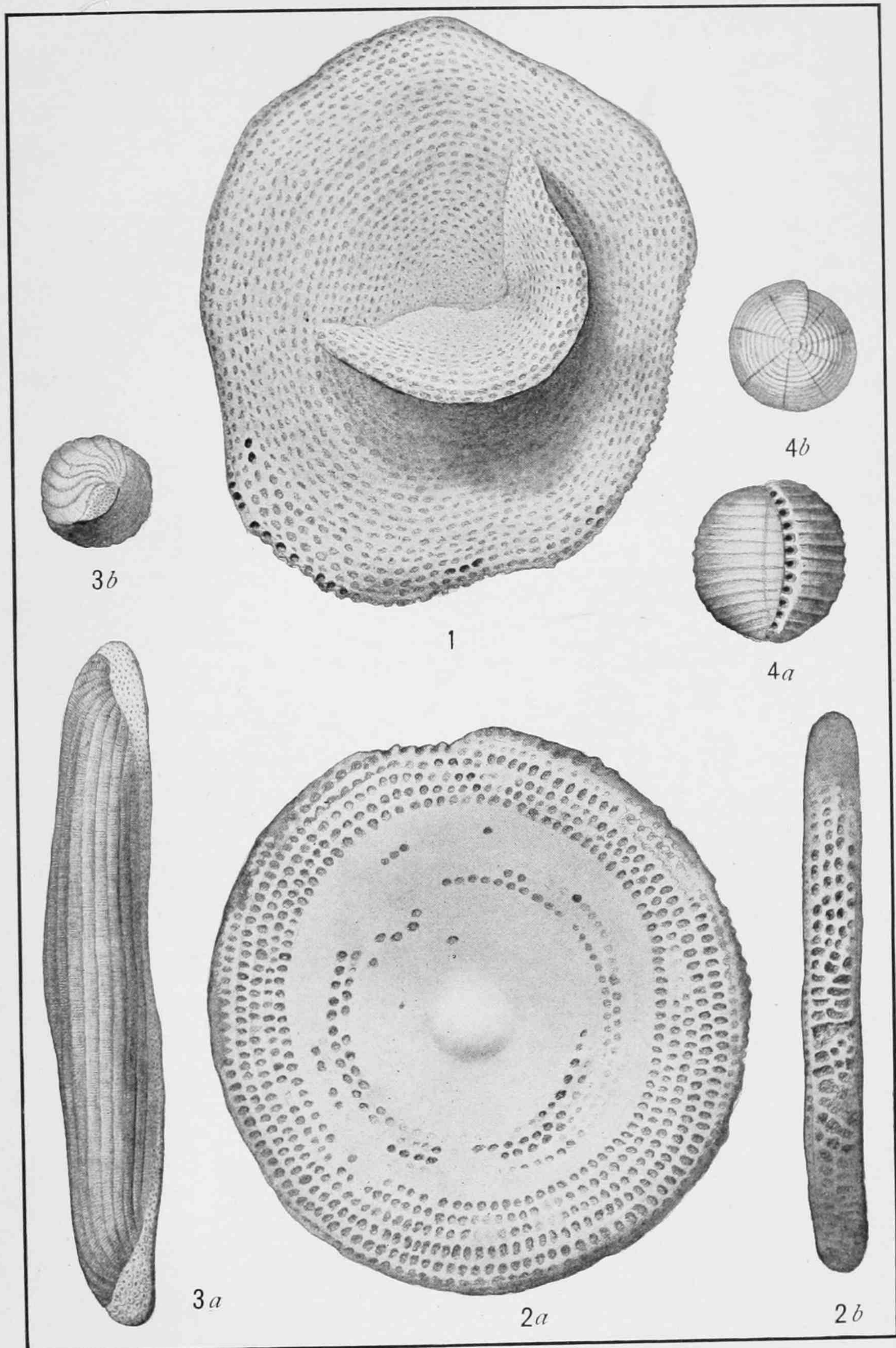

MILIOLIDAE OF NORTH PACIFIC OCEAN.

FOR EXPLANATION OF PLATE SEE PAGE 103.

# INDEX.

	Page.		Page.
acutimargo, Spiroloculina.....	31	boscii, Alveolina.....	98
Adelosina.....	73	Oryzaria.....	98
laysanensis.....	73	boueana, Miliolina.....	50
adunca, Nautilus.....	91	Quinqueloculina.....	50
Orbiculina.....	91	bradyana, Quinqueloculina.....	52
agglutinans, Miliolina.....	42	bradyi, Hauerina.....	62
Quinqueloculina.....	42	Nubecularia.....	41
agglutinata, Quinqueloculina.....	43	bulloides, Biloculina.....	79
Alveolina.....	97	canaliculata, Spiroloculina.....	30
boscii.....	98	celata, Sigmoidina.....	61
melo.....	97	circinata, Hauerina.....	63
alveoliniformis, Miliolina.....	43	circularis, Miliolina.....	67
Quinqueloculina.....	43	Triloculina.....	67
amygdaloides, Miliolina.....	51	var. sublineata, Miliolina.....	68
Quinqueloculina.....	51	Triloculina.....	68
angulata, Spiroloculina grata, var.....	36	comata, Biloculina.....	81
annectans, Massilina.....	57	var. serratula, Biloculina.....	81
anomala, Biloculina.....	79	communis, Planispirina.....	37
arenacea, Miliolina.....	44	complanata, Orbitolites.....	95
Quinqueloculina.....	44	compressa, Hauerina.....	62
arenaria, Spiroloculina.....	36	conico-articulata, Articulina.....	58
arietinus, Nautilus (Lituus).....	87, 88	Vertebralina.....	58
Peneroplis.....	88	Cornuspira.....	24
Articulina.....	58	foliacea.....	24
conico-articulata.....	58	involvens.....	25
nitida.....	59	lacunosa.....	26
sagra.....	59	planorbis.....	24
sulcata.....	60	striolata.....	27
auberiana, Miliolina.....	46	Cornuspirininae.....	24
Quinqueloculina.....	46	coronata, Biloculina.....	84
bicornis, Miliolina.....	48	Nevillina.....	84
Quinqueloculina.....	48	costata, Quinqueloculina.....	49
Serpula.....	48	costifera, Spiroloculina.....	34
var. elegans, Quinqueloculina.....	48	crenata, Massilina.....	57
bicostata, Quinqueloculina.....	47	Spiroloculina.....	57
Biloculina.....	73	cribrostoma, Miliolina.....	71
anomala.....	79	Triloculina.....	71
bulloides.....	79	cultrata, Miliolina.....	54
comata.....	81	Quinqueloculina.....	54
var. serratula.....	81	cuneata, Miliolina.....	71
coronata.....	84	Triloculina.....	71
denticulata.....	80	curta, Quinqueloculina disparilis, var.....	49
depressa.....	74	cuvieriana, Quinqueloculina.....	47
var. murrhyna.....	75	cylindrica, Miliolina.....	68
elongata.....	78	Triloculina.....	68
flintii.....	82	denticulata, Biloculina.....	80
globulus.....	78	ringens, var.....	80
lucernula.....	79	var. striolata, Biloculina.....	80
millettii.....	81	deplanata, Miliolina.....	70
murrhyna.....	75	Triloculina.....	70
ringens.....	76, 77	depressa, Biloculina.....	74
sarsii.....	76	var. murrhyna, Biloculina.....	75
semicostata.....	82	serrata, Biloculina.....	75
serrata.....	75	Spiroloculina.....	29
sphaera.....	37	disparilis, var. curta, Quinqueloculina.....	49
tubulosa.....	79	Quinqueloculina.....	48
vespertilio.....	77	duplex, Orbitolites.....	94

	Page.		Page.
dutemplei, Quinqueloculina.....	51	Miliolina circularis var. sublineata.....	68
elegans, Quinqueloculina bicornis, var.....	48	cribrostoma.....	71
elongata, Biloculina.....	78	cultrata.....	54
excavata, Spiroloculina.....	31	cuneata.....	71
ferox, Miliolina.....	54	cylindrica.....	68
Quinqueloculina.....	54	deplanata.....	70
ferussacii, Miliolina.....	50	ferox.....	54
Quinqueloculina.....	50	fichteliana.....	71
fichteliana, Miliolina.....	71	insignis.....	72
Triloculina.....	71	labiosa.....	70
flintii, Biloculina.....	82	linnaeana.....	72
foliacea, Cornuspira.....	24	macilenta.....	55
Spirillina.....	24	oblonga.....	69
foliaceus, Orbis.....	24	parkeri.....	50
fragilissima, Hauerina.....	64	procera.....	45
Spiroloculina.....	64	pygmaea.....	54
globulus, Biloculina.....	78	reticulata.....	55
grata, Spiroloculina.....	35	schauinslandi.....	56
grateloupi, Spiroloculina.....	31	secans.....	57
Hauerina.....	27, 62	seminulum.....	45
bradyi.....	62	subrotunda.....	53
circinata.....	63	terquemiana.....	72
compressa.....	62	tricarinata.....	66
fragilissima.....	64	trigonula.....	65
inconstans.....	28	undosa.....	52
pacifica.....	64	venusta.....	45
impressa, Spiroloculina.....	30	Miliolites trigonula.....	65
inconstans, Hauerina.....	28	millettii, Biloculina.....	81
Ophthalmidium.....	28	Spiroloculina.....	33
insignis, Miliolina.....	72	murrhyna, Biloculina.....	75
Triloculina.....	72	depressa, var.....	75
Vertebralina.....	39	Nevillina.....	83
involvens, Cornuspira.....	25	coronata.....	84
Operculina.....	25	nitida, Articulina.....	59
irregularis, Nodobacularia.....	40	Spiroloculina.....	33
labiosa, Miliolina.....	70	Nodobacularia.....	39
Triloculina.....	70	irregularis.....	40
lacunosa, Cornuspira.....	26	tibia.....	39
laysanensis, Adelosina.....	73	Nubecularia.....	39, 40
limbata, Spiroloculina.....	29	bradyi.....	41
linnaeana, Miliolina.....	72	lucifuga.....	41
Triloculina.....	72	nuda, Spiroloculina.....	34
lucernula, Biloculina.....	79	oblonga, Miliolina.....	69
lucifuga, Nubecularia.....	41	Triloculina.....	69
macilenta, Miliolina.....	55	oblongum, Vermiculum.....	69
Quinqueloculina.....	55	Oculina.....	27
macroposa, Orbitolites complanata, var.....	94	Operculina.....	24
Orbulites.....	94	involvens.....	25
marginalis, Orbitolites.....	92	Ophthalmidium.....	27
Orbulites.....	92	inconstans.....	28
Massilina.....	56	tumidulum.....	28
annectens.....	57	Orbis.....	24
crenata.....	57	foliaceus.....	24
secans.....	57	Orbitolites.....	92
melo, Alveolina.....	97	complanata.....	95
Nautilus.....	97	var. macropora.....	94
Miliola (Quinqueloculina) subrotunda.....	53	duplex.....	94
Miliolidae.....	23	marginalis.....	92
Miliolina agglutinans.....	42	ornatissima, Hauerina.....	63
alveoliniformis.....	43	Quinqueloculina.....	63
amygdaloides.....	51	Oryzaria bosicii.....	98
arenacea.....	44	pacifica, Hauerina.....	64
auberiana.....	46	parkeri, Miliolina.....	50
bicornis.....	48	Quinqueloculina.....	50
boueana.....	50		
circularis.....	67		

	Page.		Page.
<b>Peneroplis</b> .....	84	<b>rugosa</b> , Quinqueloculina.....	53
<b>arietinus</b> .....	87	<b>sagra</b> , Articulina.....	59
<b>carinatus</b> .....	87	Vertebralina.....	59
<b>pertusus</b> .....	86	<b>sarsii</b> , Biloculina.....	76
var. <b>arietinus</b> .....	88	<b>schauinslandi</b> , Miliolina.....	56
<b>carinatus</b> .....	87	Quinqueloculina.....	56
<b>planatus</b> .....	87	<b>secans</b> , Massilina.....	57
<b>planatus</b> .....	87	Miliolina.....	57
<b>pertusus</b> , Nautilus.....	86	Quinqueloculina.....	57
<b>Peneroplis</b> .....	86	<b>semicostata</b> , Biloculina.....	82
var. <b>arietinus</b> , Peneroplis.....	88	<b>seminulum</b> , Miliolina.....	45
<b>carinatus</b> .....	87	Quinqueloculina.....	44
<b>planatus</b> .....	87	Serpula.....	44
<b>Planispirina</b> .....	37	<b>Serpula</b> , bicornis.....	48
<b>communis</b> .....	37	seminulum.....	44
<b>sigmoilina</b> .....	61	<b>serrata</b> , Biloculina.....	75
<b>sphaera</b> .....	37	depressa, var.....	75
<b>planorbis</b> , Cornuspira.....	24	<b>serratula</b> , Biloculina comata, var.....	81
<b>procera</b> , Miliolina.....	45	<b>sigmoidea</b> , Planispirina.....	61
Quinqueloculina.....	45	Sigmoilina.....	61
<b>pygmaea</b> , Miliolina.....	54	<b>Sigmoilina</b> .....	60
Quinqueloculina.....	54	celata.....	61
<b>Quinqueloculina</b> .....	42	sigmoidea.....	61
<b>agglutinans</b> .....	42	<b>sphaera</b> , Biloculina.....	37
<b>agglutinata</b> .....	43	Planispirina.....	37
<b>alveoliniformis</b> .....	43	<b>spiralis</b> , Quinqueloculina.....	54
<b>amygdaloides</b> .....	51	<b>Spirillina</b> .....	24
<b>arenaria</b> .....	44	foliacea.....	24
<b>auberiana</b> .....	46	<b>Spiroloculina</b> .....	29
<b>bicornis</b> .....	48	<b>acutimargo</b> .....	31
var. <b>elegans</b> .....	48	<b>arenaria</b> .....	36
<b>bicostata</b> .....	47	<b>canaliculata</b> .....	30
<b>boueana</b> .....	50	<b>costifera</b> .....	34
<b>bradyana</b> .....	52	<b>crenata</b> .....	57
<b>costata</b> .....	49	<b>depressa</b> .....	29
<b>cuvieriana</b> .....	47	<b>excavata</b> .....	31
<b>disparilis</b> .....	48	<b>fragillissima</b> .....	64
var. <b>curta</b> .....	49	<b>grata</b> .....	35
<b>dutemplei</b> .....	51	var. <b>angulata</b> .....	39
<b>ferox</b> .....	54	<b>grateloupi</b> .....	31
<b>ferussacii</b> .....	50	<b>impressa</b> .....	30
<b>macilenta</b> .....	55	<b>limbata</b> .....	29
<b>ornatissima</b> .....	63	<b>milletti</b> .....	33
<b>parkeri</b> .....	50	<b>nitida</b> .....	33
<b>procera</b> .....	45	<b>nuda</b> .....	34
<b>pygmaea</b> .....	54	<b>robusta</b> .....	33
<b>reticulata</b> .....	55	<b>tenuimargo</b> .....	32
<b>rugosa</b> .....	53	<b>tenuis</b> .....	32
<b>schauinslandi</b> .....	56	<b>tenuissima</b> .....	32
<b>secans</b> .....	57	<b>unicostata</b> .....	35
<b>seminulum</b> .....	44	<b>striata</b> , Vertebralina.....	38
<b>spiralis</b> .....	54	<b>striolata</b> , Cornuspira.....	27
<b>subarenaria</b> .....	44	<b>subarenaria</b> , Quinqueloculina.....	44
<b>suborbicularis</b> .....	70	<b>sublineata</b> , Miliolina circularis, var.....	68
<b>subrotunda</b> .....	53	Triloculina circularis, var.....	68
<b>undulata</b> .....	52	<b>suborbicularis</b> , Quinqueloculina.....	70
<b>venusta</b> .....	45	Triloculina.....	70
<b>vulgaris</b> .....	46	<b>subrotunda</b> , Miliola (Quinqueloculina).....	53
<b>Quinqueloculininae</b> .....	41	Miliolina.....	53
<b>reticulata</b> , Miliolina.....	55	Quinqueloculina.....	53
Quinqueloculina.....	55	<b>subrotundum</b> , Vermiculum.....	53
Triloculina.....	55	<b>sulcata</b> , Articulina.....	60
<b>ringens</b> , Biloculina.....	76	<b>tenuimargo</b> , Spiroloculina.....	32
var. <b>denticulata</b> , Biloculina.....	80	<b>tenuis</b> , Spiroloculina.....	32
<b>striolata</b> .....	80	<b>tenuissima</b> , Spiroloculina.....	32
<b>robusta</b> , Spiroloculina.....	33	<b>terquemiana</b> , Miliolina.....	72

	Page.		Page.
terquemiana, Triloculina .....	72	Triloculina suborbicularis .....	70
tibia, Nodobacularia .....	39	terquemiana .....	72
tricarinata, Miliolina .....	66	tricarinata .....	66
Triloculina .....	66	trigonula .....	65
trigonula, Miliolina .....	65	tubulosa, Biloculina .....	79
Miliolites .....	65	tumidulum, Opthalmidium .....	28
Triloculina .....	65	undosa, Miliolina .....	52
Triloculina .....	65	undulata, Quinqueloculina .....	52
circularis .....	67	unicostata, Spiroloculina .....	35
var. sublineata .....	68	venusta, Miliolina .....	45
cribrostoma .....	71	Quinqueloculina .....	45
cuneata .....	71	Vermiculum, oblongum .....	69
cylindrica .....	68	subrotundum .....	53
deplanata .....	70	Vertebralina .....	37, 58
fichteliana .....	71	conico-articulata .....	58
insignis .....	72	insignis .....	39
labiosa .....	70	sagra .....	59
linnaeana .....	72	striata .....	38
oblonga .....	69	vespertilio, Biloculina .....	77
reticulata .....	55	vulgaris, Quinqueloculina .....	46





