

**MARINE  
CONSERVATION  
SOCIETY**



## **SPONGES OF THE BRITISH ISLES (“SPONGE V”)**

**A Colour Guide and Working Document**

**1992 EDITION, reset with modifications, 2007**

R. Graham Ackers

David Moss

Bernard E. Picton,  
Ulster Museum,  
Botanic Gardens,  
Belfast BT9 5AB.

Shirley M.K. Stone

Christine C. Morrow

Copyright © 2007 Bernard E Picton.

---

## CAUTIONS

THIS IS A WORKING DOCUMENT, AND THE INFORMATION  
CONTAINED HEREIN SHOULD BE CONSIDERED TO BE  
PROVISIONAL AND SUBJECT TO  
CORRECTION.

MICROSCOPIC EXAMINATION IS ESSENTIAL BEFORE  
IDENTIFICATIONS CAN BE MADE WITH CONFIDENCE.

---

## CONTENTS

	Page
INTRODUCTION .....	1
1. History.....	1
2. “Sponge IV” .....	1
3. The Species Sheets .....	2
4. Feedback Required .....	2
5. Roles of the Authors.....	3
6. Acknowledgements .....	3
GLOSSARY AND REFERENCE SECTION.....	5
1. Form .....	5
2. Colour.....	7
3. Smell .....	7
4. Slime .....	7
5. Consistency.....	7
6. Surface.....	8
7. Apertures .....	10
8. Contraction.....	10
9. Skeleton.....	10
10. Spicules.....	13
CLASSIFICATION .....	17
1. Introduction .....	17
2. Classification and species list .....	17
3. Demospongiae Classification Notes.....	27
4. The “Halicionas” .....	28
5. Demospongiae Skeletal drawings.....	29
TECHNIQUES .....	33
1. Introduction .....	33
2. Observation.....	33
3. Collection.....	33
4. Photography .....	33
5. Recording.....	34
6. Preservation.....	34
7. Slide Preparation.....	35
8. Identification .....	36
9. Habitat Description.....	37
10. Map of Principal Sites Cited in Text .....	40
SPECIES DESCRIPTIONS AND MINI-PRINTS.....	41
BIBLIOGRAPHY .....	152
INDEX .....	156



## INTRODUCTION

### 1. HISTORY

The “Sponges of the British Isles” has evolved from several years project work by members of the Marine Conservation Society. It had often been the shared experience among sublittoral ecologists, especially in the South of England, that whilst sponges are very important in sublittoral communities no readily available text illustrated living animals. All the literature which is relevant is scattered through the world’s journals and is written in many languages, especially English, Danish, French and German. The descriptions of the species are based largely on Museum material which has been collected either on the sea shore or by dredge, and was often preserved and dry when described.

It was against this background that the initial project was born.

The first project co-ordinator, David Guiterman, became interested in sponges in 1973, and over successive years with grants from the Royal Society and the BS-AC and the encouragement of one of the present authors (SMKS) established a working knowledge of sponge material from a wide variety of sites around the coast of the British Isles. Following a meeting between the MCS (then Underwater Conservation Society) projects co-ordinator, Bob Earll, and another of the present authors (RGA) at the Plymouth British Sub-Aqua Club AGM in 1978, it was decided to explore further the possibilities of producing an accessible collection of sponge photographs, for it seemed likely that a number of common British species of sponge could be recognised from good photographs of living material backed up by diagnostic notes. To this end a meeting was held at Bristol University in June 1978 and this succeeded in bringing together a guide and photographs which covered 16 sponge species using 22 photographs. The work of the project coordinator was supported during 1978 by grants from the NCC and BS-AC and further sponge material was collected from SW Ireland and the Menai Straits. A second meeting was held in Bristol in January 1979 which expanded the guide to cover 26 species/entities using 42 colour photographs, and a second edition of the guide was produced. This became known colloquially as “SPONGE I”.

During 1979 the work was aided by a further grant from the Royal Society. A second meeting was held in Bristol in October 1979 and it was resolved to meet once a year, and update and amend the guide on an annual basis.

For the 1980 diving season a revised and expanded text was produced, together with the addition of some new species, to prevent confusion with closely related similar species.

In 1981, David Guiterman stood down as project co-ordinator having successfully launched the project and consolidated the mini print/species list format. His place was taken jointly by Bob Earll and one of the present authors (DM), and the 1981 package was launched with a significant change in emphasis. Originally, the package was viewed as a “recognition guide”, with the mini prints giving clues as to the identity of a sponge. It outlined possibilities and suggested the degree of confidence that survey ecologists could place on both the names and identity of prominent sublittoral species, based on appearance alone. In 1981, it was decided that the package would become a much more broadly based identification guide, with a view to coordinating efforts on all fronts to increase our knowledge of sponge identification. Sheets were produced for a further 6 species, and an additional 22 mini prints were produced. For the first time, some reddish-brown encrusting forms were included. The 1981 package was known as “SPONGE II”.

The work for 1982 was formulated at a meeting of the working group at the Natural History Museum in November 1981. Bob Earll stepped down as one of the co-ordinators, and his place was taken by RGA. Behind the scenes the project was being steered by a working group consisting of Frances Dipper, Bob Earll, BEP and SMKS, plus the then two project co-ordinators RGA and DM. The resulting package, “SPONGE III” was issued in 1982, with the addition of 18 new species, 42 new mini-prints, and numerous revisions to the text. Furthermore, participation was encouraged in two “sub-projects”, one covering the “*Haliclona*’s”, and another the geographical distribution of British sponges in addition to the main project centred around the Sponge Recording Form. Two sponge workshops were held, one in June 1983 at Menai Bridge, and the other in June 1984 in South Devon.

The working group held further meetings in December 1982 and June 1983, from which emerged “SPONGE IV”.

### 2. “SPONGE IV”

The “SPONGE III” package proved difficult to assemble for a variety of reasons. These problems were addressed in “SPONGE IV”, which was completely rewritten, and so superseded all previous texts. Five new species were included - *Thymosia guernei*, *Terpios fugax*, *Adreus fascicularis*, *Aphysilla sulfurea* and *Halisarca dujardini*, and 22 new mini-prints were added covering these, as well as some previously included species. Furthermore, the process of “splitting” some of the *Calcarea* was started, and separate species sheets were produced for some of the “*Haliclona*’s”. The glossary, classification, techniques, and bibliographical information were expanded. A new addition was a “Table of Species Characteristics” which may facilitate species recognition. Finally, an alphabetical Index of all species names and technical terms was supplied for the first time.

### 3. “SPONGE V”

The 1989 fire at MCS headquarters which destroyed the offices and their contents unfortunately resulted in the destruction of stocks of text and miniprint internegatives used in previous editions of this guide. BEP, RGA and DM had already begun work on a supplement to “SPONGE IV” intending to add as many new species as could be adequately characterised from newly collected and photographed material. This supplement was intended to cover only the new species sheets and miniprints together with an index to allow it to be added to existing “SPONGE IV” copies. In the summer of 1990 the Worldwide Fund for Nature (WWF) and the Nature Conservancy Council (NCC) generously gave funds to employ a student, Christine Morrow to transfer the old “SPONGE IV” text to a word-processor and prepare new drawings of spicules from spicule preparations of recently collected material in the collections of the Ulster Museum. The

new spicule drawings were prepared either by tracing from scanning electron microscope (SEM) photographs taken specially at the Electron Microscope unit, Queen's University Belfast, or by using a drawing tube on a light microscope, and are therefore far more accurate than previous illustrations in these guides. The spicule preparations were also used to make measurements of spicules which are quoted in this edition as eg. 120-(210)-300µm, this being the range and average of ten spicules measured at random. Sizes outside this range do occur, if mentioned elsewhere in the literature, they are given in quotes eg. "100-350µm". However the authors feel that these figures are often given on the basis of material from outside the British Isles which may not always be conspecific and extremes of sizes are not always meaningful. The text and graphics for this edition were combined using desktop publishing software on an IBM compatible PC. The voucher specimens, slides and SEM photographs are stored in the Ulster Museum and referenced in this guide by catalogue numbers with the prefix BELUM : Mc. (eg. "BELUM : Mc138").

A new set of photographs was assembled from the far wider choice available in 1990 without the constraints of re-using the previous miniprints. Wherever possible photographs supported by voucher specimens have been used and are referred to by catalogue numbers in this guide. Experience with *in situ* observation of sponges enabled a more representative choice of photographs without the duplication which had arisen in the past and this helped keep the cost of the latest edition down. Additionally the text was made more authoritative in many places where more confidence had been gained with field characters. The text was fully revised to incorporate new information on intra-species variability, habitats and distribution in particular. The classification was revised in accordance with the latest information and a list of British sponges compiled for the MCS Species Directory (Howson, C.M., 1987) has been incorporated in place of the classification section of "SPONGE IV". The text and graphics are now stored on computer disk which will facilitate production of further editions.

In 2007 the text was reset in Adobe InDesign and photographs incorporated so that the document could be distributed as a PDF file. This work was carried out mainly by Christine Morrow with assistance from Bernard Picton. Where possible the original photographs were rescanned from slides. The classified species list was revised in accordance with *Systema Porifera*, 2002. Christine was sponsored by Countryside Council for Wales and JNCC to carry out this work and to transfer the contents of this guide to a website. The work was refereed by *MarLIN*.

#### 4. THE SPECIES SHEETS

There are now a total of 105 species sheets. In one case (*Myxilla* cf. *rosacea*) there are doubts over the species name, and in several cases more than one species may be involved. These difficulties serve to emphasise that the information in all the species sheets must be treated with caution, and is subject to change. It is inherent in the study of sponges that exceptions are encountered soon after a character, or some ecological data, was thought to have been fixed! Many of the sheets may turn out to describe **specimens** rather than **species** for which a whole series of specimens is required. On the other hand it is apparent that many undescribed species are to be found in British waters and differences which have been put down to intra-specific variability in the past may actually indicate the existence of complexes of similar or sibling species. The work on *Suberites ficus* in the Isle of Man using enzyme electrophoresis forces a re-examination of classical taxonomic techniques relying mostly on spicule morphology (Solé-Cava & Thorpe, 1986). As a convention in the sheets, quotation marks "" indicate a quotation from the literature which has not been verified by the authors, rather than a recent observation. Confirmation or refutation of such information will be valuable.

#### 5. FEEDBACK REQUIRED

From the above comments it can be seen that this is very much a working document, and new information is eagerly sought. Any information should be sent to RGA (address on title page) who will also be prepared to give advice and supply recording sheets.

- 5.1. Collection and Recording of Specimens. The methods are described in the Techniques section. It is frequently the total absence of habitat information from the traditional records which makes an understanding of sponge taxonomy so difficult. This is clearly one area where diving and shore observations are very valuable. Information so collected can be incorporated into future versions of this Guide. This Guide also lays emphasis on external characters visible in living sponges, and underwater photography of living sponges *in situ* is strongly recommended.
- 5.2. Verification of the Guide. Information is urgently required at two levels. Firstly, comments on the general layout and accuracy of the whole text including the species sheets. Secondly, it is of paramount importance for the authors to know how easy or difficult it is found to use the Guide for provisional identification of sponges. Criticisms will help to improve the style of the descriptions in future editions.
- 5.3. Photographs. Photography is invaluable as a record of the living sponge, and its habitat. The authors would be pleased to receive good photographs of sponges, preferably where a voucher specimen exists, for possible inclusion in future editions.
- 5.4. Observations. These would be welcomed from any part of the British Isles to extend our geographical distribution records. Due to the difficulties of identification records should be supported by good photographs, and/or voucher specimens. The North Sea coasts are particularly in need of investigation.
- 5.5. The '*Haliclona*'s. Although some progress has been made with this difficult group, information is still required - see sub-section 5 of the Classification section for details.
- 5.6. Other specialisations. To advance the Guide further some degree of specialisation may be required. The authors would be pleased to hear from anyone who might be interested in looking into the Calcarea, Suberitidae, *Cliona* spp., *Halichondria* spp., *Hymeniacidon* sp., *Myxilla* spp., *Hymedesmia* spp., or *Microciona* spp. in more detail. Also anyone interested in looking at particular habitat niches, such as the sponges occurring on *Chlamys* and *Aequipecten* valves.

## 6. ROLES OF THE AUTHORS

The principal roles of the authors were as follows.

- RGA General editorial. Assemblage of current mini-prints. Revision of non-species sections. Some contribution to species descriptions.
- DM General editorial. Production of “SPONGE IV”. Detailed editorial of, and some contribution to, species descriptions.
- BEP Major contribution to species descriptions and classification. Supply of the majority of the photographs. Preparation and supervision of spicule and skeletal drawings. Editorial and final preparation of “SPONGE V” text and illustrations.
- SMKS Major contribution to species descriptions, classification and glossary. Chief technical adviser.
- CCM Preparation of spicule preparations, SEM photographs, text and drawings for SPONGE V. Preparation of 2007 edition and updating of nomenclature to agree with *Systema Porifera*, 2002.

## 7. ACKNOWLEDGEMENTS

The authors would like to thank the following people for their contributions to this Guide.

Bob Earll, for considerably advancing the project in 1981, offering much helpful advice and encouragement, and contributing to the Table of Species Characteristics.

David Guiterman, who originally founded the project, and some of whose work remains in this edition.

W. Clifford-Jones, for writing several species sheets, supplying mini-prints, and for his interest and encouragement.

Rob van Soest, for helpful comments on “SPONGE III” and his continued support of this project.

Wallie de Weerd, for help with the Haplosclerids.

Roger Telford, for help with computer imaging and other facilities in production of “SPONGE V”.

Jim McRae and the staff at Queen’s University Electron Microscope Unit for help with SEM photography for spicule details in SPONGE V.

The production of the 2007 edition and transfer of the contents of this guide to a website, was sponsored by Countryside Council for Wales and JNCC and refereed by *MarLIN*. We would like to thank Rohan Holt, Keith Hiscock and Guy Baker for facilitating this.

There are a number of other people who have contributed in some way to the Guide; most are acknowledged in appropriate places in the text.





## GLOSSARY AND REFERENCE SECTION

The purposes of this section are threefold:

- To act as a reference for the definition of any terms found in the text. To track down such a term, refer firstly to the Index.
- To serve as a general introduction to some of the terminology associated with sponges. To this end, the sections in this glossary correspond to the headings found in the species description sheets. Within each section, the terms are then arranged in an appropriate, logical sequence.
- To indicate the terms available and the information that should be observed and noted when recording a sponge specimen.

Where adequate and precise definitions have been previously published, these are reproduced verbatim. The main sources are Borojevic, Fry et al, 1968 and Weidenmeyer, 1977 (abbreviated to B. and W. respectively). Other sources are noted in the text. Definitions not contained within quotation marks have been prepared specifically for this Guide.

### 1. FORM.

#### 1.1 Terms relating to the shape of the sponge.

The terms in this section are arranged approximately in order of increasing mass and/or complexity of body form.

- Boring**
- Some or all of the sponge is contained in channels within a hard substrate such as shell or limestone.
  - No basal attachment area. (e.g. the alpha stage of *Cliona celata*.)

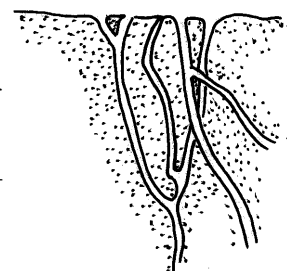

- Thin sheets**
- Growth predominantly lateral, resulting in spreading sheets less than 3mm thick.
  - Attachment basal area continuous. (e.g. *Microciona atranguinea*).



- Cushions**
- Growth predominantly lateral, resulting in spreading sheets between 3 and 10mm thick.
  - Attachment basal area continuous. (e.g. *Myxilla fimbriata*).



- Massive-lobose**
- Growth vertical and lateral but unequal, greater than about 10mm; if growth is predominantly vertical results in lobed forms; if growth is predominantly lateral results in ridged forms.
  - Attachment area matches greatest body width e.g. *Myxilla incrustans*).



- Massive-globose**
- Includes forms which are globular, hemispherical or disc-shaped.
  - Growth vertical and lateral.
  - Attachment basal area as much as greatest body width (i.e. hemispherical) or slightly less than greatest body width (i.e. globular). (e.g. *Polymastia boletiformis*).

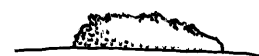

- Massive-pear**
- Growth vertical and lateral but unequal.
  - Attachment basal area as much as, or slightly less than, the greatest body width.



- Massive-fig**
- Growth vertical and lateral but unequal.
  - Attachment basal area less than the greatest body width (e.g. *Suberites carnosus*).



**Massive-flanged**

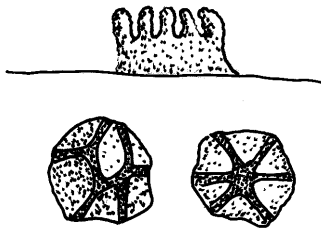

- a. Growth vertical and lateral but unequal. Vertical growth can proceed at variable rates, infilling the spaces between the erect, flattened ribs or flanges of immature sponge. Viewed from above, flanged crests can either be regular, radiating out from the centre like spokes of a wheel, or irregular, set at angles to each other.
- b. Attachment basal area corresponds to greatest body width.

**Cylindrical**

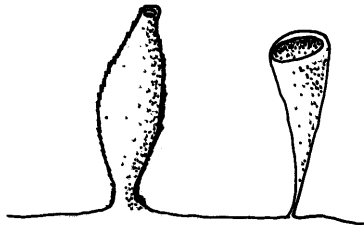

- a. Includes forms which are tubular, club-shaped, spindle-shaped.
- b. Growth predominantly vertical and columnar, but because it is more raised at outer edges, a hollow centre is formed but this becomes invisible when the apical opening becomes reduced to an oscule, and effect is closed. Hollow centre may later become infilled so cylinder appears to be solid and apical opening is no longer apparent.
- c. Cylinder may be circular in cross-section or ellipsoidal when cylinder is laterally compressed.
- d. Attachment basal area less than the greatest body width (e.g. *Sycon ciliata*).

**Cuplike**



- a. Includes forms resembling vases, funnels and cups.
- b. Edges of walls may be discontinuous, i.e. may only be joined together at lower margins, forming a notch, but here they are treated as cups.
- c. Growth predominantly vertical and spreading, but because it is more rapid at outer edges, a hollow centre is formed which remains visible - effect is open.
- d. Attachment basal area less than greatest body width (e.g. *Axinella infundibuliformis*).

**Lamellate**



- a. Includes forms resembling fans (flabellate forms) and flaps (i.e. vertical sheets).
- b. Includes erect fans lying in one plane, to fans curved round to resemble cups or even whorls, but whose free edges never join at any point to form actual cups.
- c. Growth is predominantly vertical.
- d. Attachment basal area less than greatest body width (e.g. *Axinella flustra*).

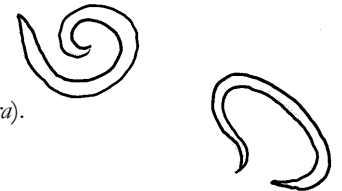

**Branching-repent**

- a. Branches may be simple or fused, cylindrical or flattened in cross section, solid or hollow.
- b. Growth is predominantly horizontal.
- c. Attachment basal area large in proportion to body bulk, though it may not be continuous (e.g. *Haliclona simulans*).

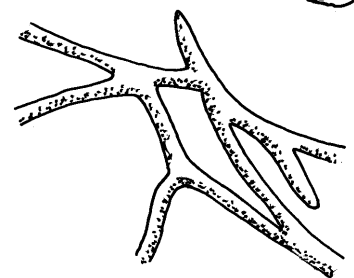

**Branching-erect**

- a. Branches may be simple or fused, cylindrical or flattened in cross-section, solid or hollow.
- b. If growth is predominantly vertical, results in erect and free forms (i.e. tree-like), with regular or irregular branching. If growth is predominantly horizontal, results in semi-erect, free forms whose branches lie parallel to the substratum. The stalk is usually visible adding to the erect impression, cf. repent.
- c. Attachment basal area is small in proportion to body bulk (e.g. *Axinella dissimilis*).

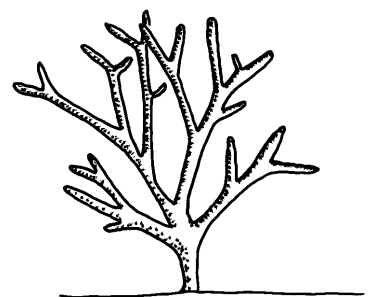

## 1.2 Miscellaneous terms

These are some terms that might be encountered in the description of form (as well as in other contexts).

**Mesial/medial** of or situated in the middle.

**Dichotomous** Branching by repeated division into two roughly equal parts.

**Polytomous** Branching by division into more than two parts.

**Anastomose** To join or merge, e.g. as in branches which fuse together.

**Stipitate** Stalked.

**Rooting tufts** Processes anchoring the sponge into a soft substrate. Common in deep sea sponges.

## 1.3. Sponge dimensions

Measure height, length and width (in cms). It is preferable to indicate these dimensions on a sketch.

## 2. COLOUR

Despite the familiarity of the concept of colours the recording of colour without a basis for comparative reference can be highly subjective. It is therefore strongly recommended that colours are recorded with the assistance of the Methuen Handbook of Colour (Kornerup and Wanscher, 1978). Many colour descriptions in the species sheets have not used this (or any other) basis of reference, but we hope to standardise gradually on this book. In general many sponges develop more pigment in high ambient light levels, so colour is variable both with predominant water clarity, depth, and topographic position of the colony.

## 3. SMELL

Most marine sponges produce little smell out of water or, if they do, it is a general “marine” odour. However, in a few cases, odours are emitted which can be distinctive, and may be even diagnostic. Unlike people in the wine trade, spongologists have not evolved a vocabulary for smell, which must for the time being be likened to other smells that are familiar.

## 4. SLIME

Many sponges produce mucus as a defence against the settlement of detritus, or other marine organisms. The extent to which this slime is exuded on collection can be diagnostic. For example, *Polymastia boletiformis* gives off no slime, *Myxilla rosacea* exudes a lot, *Haliclona viscosa* is only obviously slimy when crushed, and *Haliclona cinerea* produces slime strands when pulled apart. It is therefore important to record the amount of slime, and how it is exuded.

## 5. CONSISTENCY

Again, a language for consistency is still evolving. Terms used are everyday adjectives, but their meanings in the context of sponge descriptions are given below. They should be qualified with “very”, “slightly”, etc. as appropriate.

### 5.1 General Consistency

**Soft** Like wet cotton wool (e.g. *Rhabdostyla kitchingi*).

**Compact** Firm and rubbery (e.g. *Polymastia boletiformis*).

**Hard** Treat as a quality distinct from firmness (see below). A hard sponge is one with a surface like wood. (e.g. *Haliclona simulans*).

### 5.2 Reaction to pressure

**Compressible** Easily compressed (e.g. *Dysidea fragilis*).

**Firm** Requires considerable pressure to deform the sponge. Like the rubber of a car tyre. (e.g. *Pachymatisma johnstonia*).

**Incompressible** Does not compress (e.g. *Stelletta grubii*).

**Elastic** How far does the sponge return to its original shape after compression? Like a bath sponge if elastic (e.g. *Dysidea fragilis*).

**Inelastic** Where any deformation is retained (e.g. *Pachymatisma johnstonia*), and there is no tendency to return to the original shape. Like ‘styrofoam’ used by flower arrangers to hold water and plant stems.

### 5.3 Characteristics when torn or broken

**Fragile** Easily falls to pieces (e.g. *Microciona armata*).

**Brittle** Easily breaks (e.g. *Haliclona simulans*).

**Tough** Resistance to tearing: this property is in most cases covered by firmness (see above). However, uneven distribution of strengthening tissues may lead to unexpected results which are worth recording (e.g. *Dysidea fragilis*).

5.4 Characteristics when manipulated

- Fleshy** Tendency to be gelatinous with reduced or non-existent skeleton (e.g. *Thymosia guernei*).
- Crumbly/Friable** Easily broken into small pieces when rubbed between the fingers (e.g. *Haliclondria panicea*).
- Slimy** Mucus is apparent when sponge is rubbed between the fingers (e.g. *Stelligera rigida*). See section 4 above.

6. SURFACE

6.1 Profile view

**Even** The gross surface profile has smooth lines, without marked irregularities. (e.g. *Pachymatisma johnstonia*).

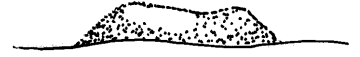

**Uneven** Opposite to above (e.g. some forms of *Myxilla incrustans*).

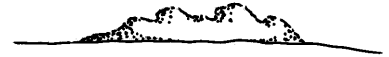

**Wrinkled** Parts or all of surface thrown into wrinkles.

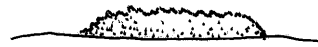

**Irregular Folds** In some parts the surface fold over onto itself (e.g. some forms of *Hymeniacidon perleve*).



6.2 Projections

**Smooth** No projections, hairs or depressions (e.g. *Pachymatisma johnstonia*).

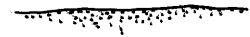

**Tuberculate** Warty appearance caused by small rounded projections (e.g. some forms of *Stylostichon plumosum*, *Tethya aurantium*).

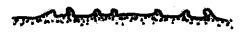

**Conulate** Pyramidal cone-shaped projections, often caused by lifting of surface due to protruding end of skeletal fibres (e.g. *Dysidea fragilis*).

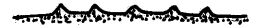

**Fistulate** Hollow, narrow, reed-like tubes, averaging less than 5mm long (e.g. the smaller processes usually present on *Haliclona fistulosa*).



**Papillate** Hollow, strap-like tubes averaging more than 5mm long (e.g. *Polymastia* spp.).

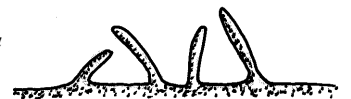

**Branching processes** Longer, tassel-like, processes thrown off from the surface, which may branch and/or anastomose (e.g. *Amphilectus fucorum*, *Haliclona fistulosa*).

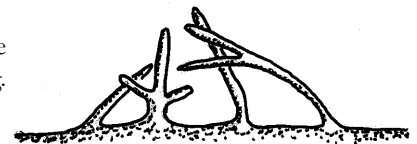

**Oscular chimneys** Mammillate to cylindrical surface projections bearing oscules (e.g. *Haliclona viscosa*).



**6.3 Hairs** Hairs consist of spicules projecting through the surface.

**Spinose** Coarse, short, stiff, bristly hairs, usually widely spaced.

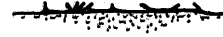

**Hispid** Long, closely-packed hairs.

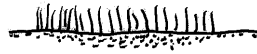

**Hirsute** Rough, coarse, untrimmed hairs, shorter than hispid.



**Villose** Long, shaggy hairs, slender and soft but not matted; longer than hispid (e.g. *Stelligera rigida*).

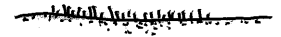

**Velutinous** Velvety; hairs dense, firm and straight (e.g. *Suberites carnosus*).

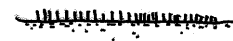

**6.4 Depressions**

**Punctate** Punctured; surface dotted with pin-point impressions (e.g. inner surface of *Axinella infundibuliformis*).

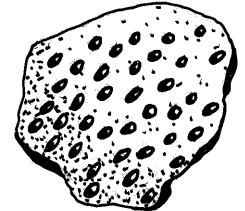

**Striated** Marked with longitudinal or parallel lines (e.g. *Adrens fascicularis*).

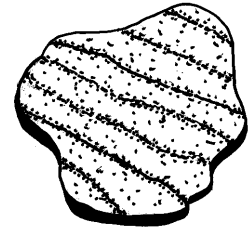

**Sulcate** Furrowed with longitudinal or parallel channels. (e.g. *Mycale lingua*)

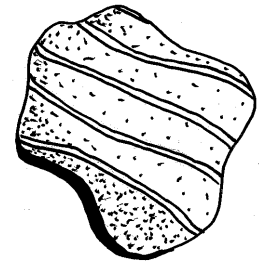

**Polygonal grooves** Grooves in surface forming polygonal shapes.

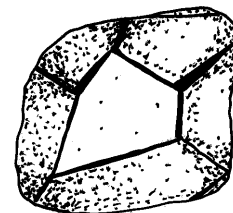

**6.5 Subsurface features**

**Canal patterns** Subsurface exhalant canals are sometimes seen through the surface especially in encrusting species (e.g. *Microciona atranguinea*).

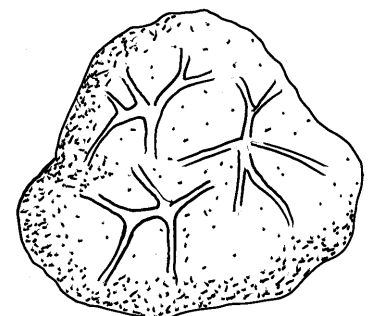

**Cavities**

These sometimes occur below, and show through the ectosome (e.g. *Dysidea fragilis*).

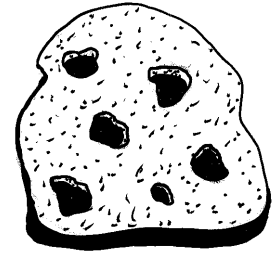

**6.6 Feel**

**Granular**

Has a gritty feel (e.g. *Pachymatisma johnstonia*).

**Leathery**

Feels like leather.

**Slippery**

Negligible friction, may be caused by mucus (e.g. *Homaxinella subdola*).

**High friction**

Like a pencil eraser (e.g. *Haliclona simulans*).

**Moderate friction**

Anything in between the previous two (e.g. *Myxilla incrustans*).

**7. APERTURES**

**Ostium**

“Any opening through which water enters a sponge” (B., p.1231).

**Oscule (=osculum)**

“An aperture through which water leaves a sponge” (B., p.1231).

Normally, ostia are small, sometimes not visible or obvious to the naked eye, whereas oscules are prominent. It is important to note whether apertures are scattered, grouped, in a linear series, or some other arrangement; their frequency; and whether they are open or closed before and after collection.

**8. CONTRACTION**

Although certain sponges have been reported to respond to the presence of a diver underwater, contraction usually occurs only on physical disturbance and/or removal from the water. Its occurrence and degree should be noted - i.e. none, slight, marked.

**9. SKELETON**

Terms described in the first section are anatomical, and in the remaining sections are skeletal.

**9.1 Anatomical Terms**

**Choanocyte**

“A cell bearing a flagellum, which is surrounded by a collar of cytoplasmic microvilli” (i.e. finger-like projections) (B.,p.1232)

**Choanocyte chamber**

“Any cavity lined by choanocytes” (B., p.1231).

**Flagellated chamber**

Synonymous with, but less precise than, the previous term. It is preferable to avoid using it.

**Ectosome**

“Peripheral region of a sponge, devoid of choanocyte chambers” (B.,p.1231).

**Choanosome**

“A region of a sponge, containing choanocyte chambers” (B.,p.1231). i.e. loosely the interior of a sponge.

**Pinacoderm**

“A unistratified layer of cells, other than the choanoderm delimiting the sponge from the external milieu” (B.,p.1231).

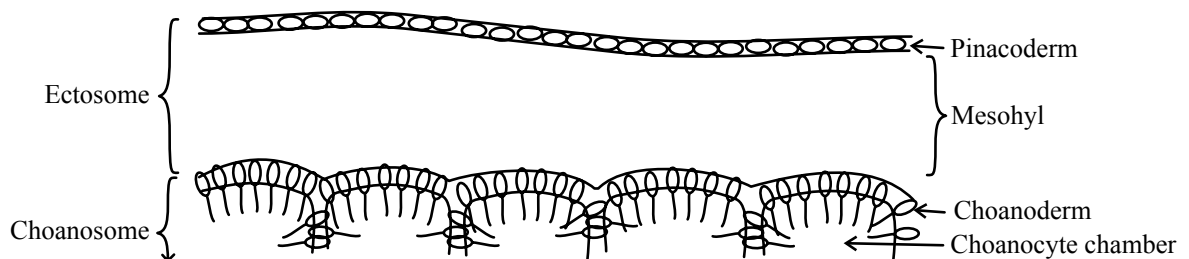
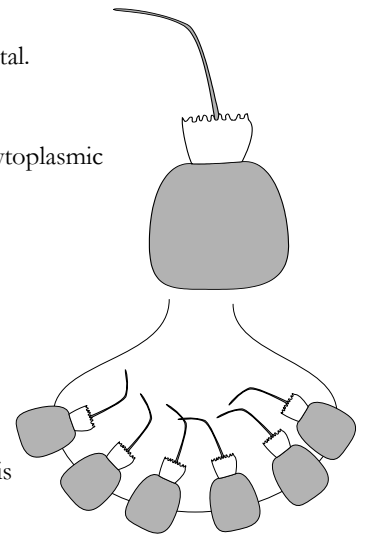

<b>Choanoderm</b>	“A single layer of choanocytes” (B., 1231).
<b>Mesohyl</b>	“Everything constituting the sponge between the pinacoderm and the choanoderm” (B., 1231).
<b>Cortex</b>	“A layer of the ectosome consolidated by a distinctive skeleton” (B., 1231).
<b>Spherulous cells</b>	Cells containing large, round vacuoles, occupying most of the cells.(e.g. <i>Mycale similaris</i> ).

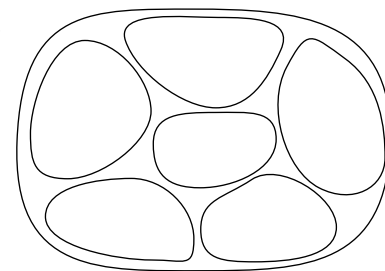

## 9.2 Skeletal components

<b>Skeleton</b>	“All structures of which the primary function is the consolidation and mechanical protection of the sponge” (B., p.1231).
<b>Spicule</b>	“A discrete autochthonous element of the skeleton consisting mainly of silica or calcium carbonate” (B.,p.1231). (Autochthonous means they are indigenous to the sponge which has secreted the spicules.) Section 10 (following) is a glossary of terms used to describe spicules.
<b>Collagen</b>	The major structural protein of the animal kingdom.
<b>Fibrillar collagen</b>	Fibrils of collagen dispersed throughout the intercellular matrix.
<b>Spongin</b>	“Proteinaceous horny skeletal material, either alone [as in bath sponges], or binding siliceous spicules together [as in <i>Haliclona</i> or <i>Microciona</i> ],” (W.,p.48, quoting Hartman, 1964). Another type of collagen.
<b>Fibre</b>	A discrete column of spongin, either without spicules, (e.g. <i>Aphysilla</i> ) or cored by indigenous spicules (e.g. <i>Haliclona</i> ) or filled with foreign spicules and/or debris (e.g. <i>Dysidea</i> ). In some sponges (e.g. the Haplosclerids) the distinction is made between primary fibres, which run perpendicular to the surface, and secondary fibres, which run parallel to the surface (after W.,p.38).
<b>Tract</b>	“A column or (rarely) single line of bundled, overlapping, or aligned monaxonic megascleres, with or without spongin cement” (W.,p.50).

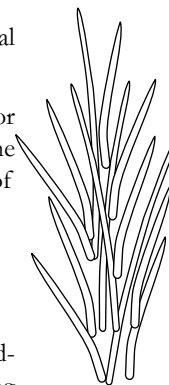

## 9.3 Skeleton Arrangements

<b>Ascending</b>	Used mainly of fibres and tracts (q.v.), where they extend to the surface and end orientated perpendicular to it (equivalent to ‘vertical’).
<b>Echinating</b>	Literally “covered with spines, bristles, or bristle-like outgrowths”. In the context of sponge skeletal arrangements, the term is used to describe monactinal spicules standing off, or projecting from, another structure.
<b>Palisade</b>	Spicules arranged like a fence.

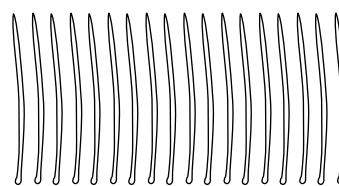

<b>Plumose fibre, column</b>	“A fibre or column usually ascending, with monaxon megascleres radiating obliquely upward from the axis, points outwards; these columns commonly anastomose; they characterize axinellid structure” (W.,p.42)
------------------------------	---



<b>Radiate structure</b>	“Skeletal architecture characterized by megascleres oriented radially from the centre of the sponge, and commonly by lack of spongin” (W.,p.44).
--------------------------	--

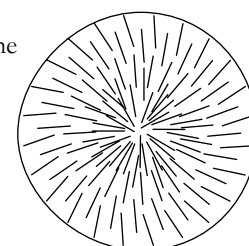

<b>Isotropic reticulation</b>	“Reticulation which is disorientated, random, and in which there is no distinction of primary and/or secondary fibres or tracts” (W.,p.39).
-------------------------------	---

**Isodictyal reticulation**

“Isotropic reticulation in which the meshes are commonly triangular in all directions, outlined by single monaxon megascleres which are joined at their tips, with spongin cementing the nodes” (W.,p.39).

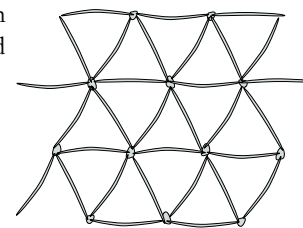

**Anisotropic reticulation**

“That type of reticulation which is oriented with respect to the surface, and in which either primary, or secondary fibres (or tracts) or both can be distinguished” (W.,p.31).

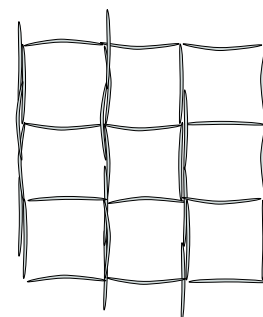

**Plumoreticulate**

Plumose columns arranged in a network.

**9.4. Skeletal Arrangements Implied by Reference to Taxa**

**Choristid**

From the Order Choristida (replaced by Astrophorida in the classification scheme used in this Guide). “The type of skeletal architecture distinguished by predominantly radiate, occasionally confused, arrangements of megascleres including triaenes with cladomes outward, by lack of spongin, and commonly by a cortex” (W.,p.34). See the figure of *Stelletta grubii* on page 34 showing part of the cortex.

**Halichondroid**

From the Order Halichondrida. “The type of skeletal architecture characteristic of *Halichondria* and some other sponges, i.e. with megascleres arranged in vague tracts which may be reticulate; or scattered in sheets between alveoles and stouter ascending tracts” (W.,p.39). In sections the spicules often appear as a disorganised, criss-crossing mass.

**Hymedesmoid**

From the subfamily Hymedesmiinae. In encrusting sponges, that part of the skeleton consisting of large primary acanthostyles perpendicular to the substrate, and smaller acanthostyles echinating the substrate. See the figure of *Hymedesmia paupertas* on page 36 showing a perpendicular section through the entire sponge.

**Renieroid**

From the Genus *Reniera* in the Family Haliclona. “The type of reticulate structure as in *Haliclona* (*Reniera*), i.e. an anisotropic reticulation of diacts which is commonly unispicular, with spongin at the nodes; or with ascending tracts within an isotropic or anisotropic interstitial reticulation of single diacts” (W.,p.44). These three variations are figured below.

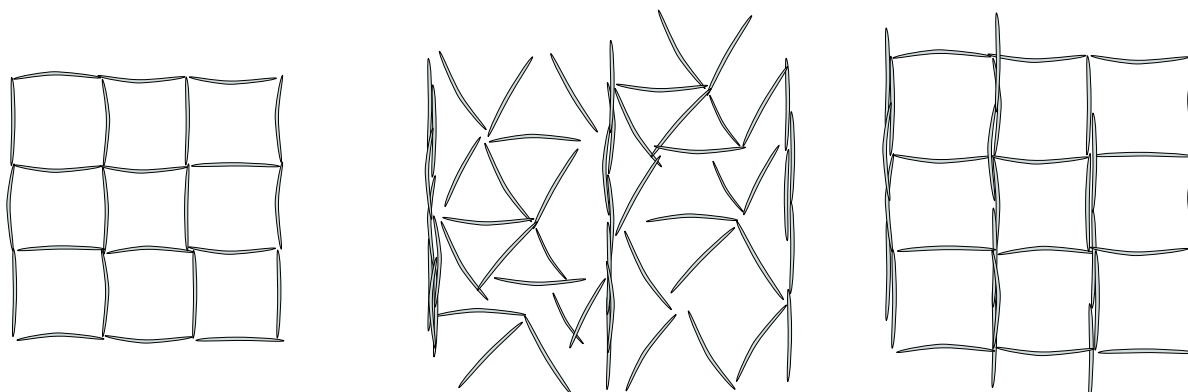



## 10. SPICULES

Because the types, shapes and sizes of spicules tend to be consistent within a species, they are very important characters for sponge classification. Their great variety has attracted a complex nomenclature, unfortunately not entirely avoidable. However, this glossary is restricted only to spicules mentioned in the species descriptions. Various narrative definitions are given below, but the essence of the glossary is in the figures on pages 14 and 15 as the authors feel that direct visual comparison is always far better than complex jargon. On the whole, it was felt unnecessary to supplement these figures with turgid and precise definitions, and this has largely been avoided. Terms appearing below either do not occur on pages 14 and 15 (but do in the text), or are included to clarify the figures where this was felt to be necessary.

- Monact(inal)** “Any spicule (megasclere or microsclere) having one ray, which grew from one end only; with ends fundamentally different in form” (W.,p.42). The four spicules to the upper right of page 14 are monacts.
- Diact(inal)** “Any spicule (megasclere or microsclere) having two diverging rays; being commonly but not always bilaterally symmetrical (with conforming ends)” (W.,p.36). The six spicules to the upper left of page 14 are diacts.
- Monaxon** “Any linear, non-radiate spicule; or a spicule type never having more than two rays along one axis. This collective term includes both actinal and diactinal spicules” (W.,p.42). Thus all the spicules on the upper row of page 14 are monaxons, as are the microrhabds and sigmatoscleres on page 15.
- Triact(inal)** “Any radiate spicule (megasclere or microsclere) having three rays. Such spicules are most frequent in Calcarea, rare in Hexactinellida (as reduced hexacts) and in Demospongia (as reduced tetraxons)” (W.,p.50).
- Triradiate** Synonymous with triact - used in this Guide to describe calcareous spicules.
- Tetract(inal)** “Any radiate spicule (megasclere or microsclere) having four rays” (W.,p.49). The lower row of spicules on page 14 are tetracts.
- Quadriradiate** Synonymous with tetract - used in this Guide to describe calcareous spicules.
- Acantho-** “Prefix meaning spined” (W.,p.30, quoting Hartman, 1964b). Acanthostyles occur frequently in the sponges in this Guide.

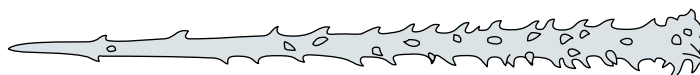

Acanthostyle

- Tylote** “A diactinal megasclere with a tyle on each end.” See page 14 “Also an adjective meaning provided with one or more tyles”. A tyle is “Any rounded swelling or knob in a spicule, other than the centrum” (W., p.50). (Note that a centrum is “The globular centre of many euasters” (W.,p.33).)
- Centrotylote** A median swelling (tyle) in a spicule. See centrotylote oxea on page 14, and centrotylote microxea on page 15. (e.g. *Suberites ficus*)
- Polytylote** A spicule with a series of swellings along the shaft. (e.g. Styles of *Polymastia conigera*)
- Megasclere** “The larger spicule types, comprising the major structural elements of a sponge skeleton” (W.,p.40, quoting Hartman, 1964). All spicules illustrated on page 14 are megascleres.
- Calthrops** “Tetraxon megasclere with equal rays arranged normal to faces of a tetrahedron” (W.,p.33, quoting de Laubenfels, 1955). See page 14. The point to note is the symmetry of calthrops spicules. (e.g. *Dercitus bucklandi*)
- Triaene** “Any tetraxial, tetractinal megasclere having one unequal ray (termed rhabd) which is commonly much longer than the other three (known as clads, together forming the cladome), occasionally shorter, or modified. Triaene is a collective term.” (W.,p.50)- the complete definition of this term is quite lengthy, and so not reproduced here in full.) See page 14, and the figure of *Stelletta grubii* on page 34.
- Microscleres** “Relatively very small spicules of various forms, characteristic of certain sponges” (W.,p.41, quoting Hartman, 1964). The following four definitions are for the categories of microscleres encountered in this Guide. The spicules illustrated on page 15 are all microscleres.
- Microrhabds** “A collective term for monaxon microscleres, excluding sigmatoscleres and spirocleres. Among the simple forms are microxea, microstrongyle, microstyle (comma), raphide; among the ornamented (e.g. spined) forms are sanidaster and its variants, which were once regarded as asters” (W.,p.41). See the top row of page 15.
- Sigmatoscleres** “A group of monaxon microscleres including sigma and its variants” (W.,p.47). See the central group of spicules on page 15.

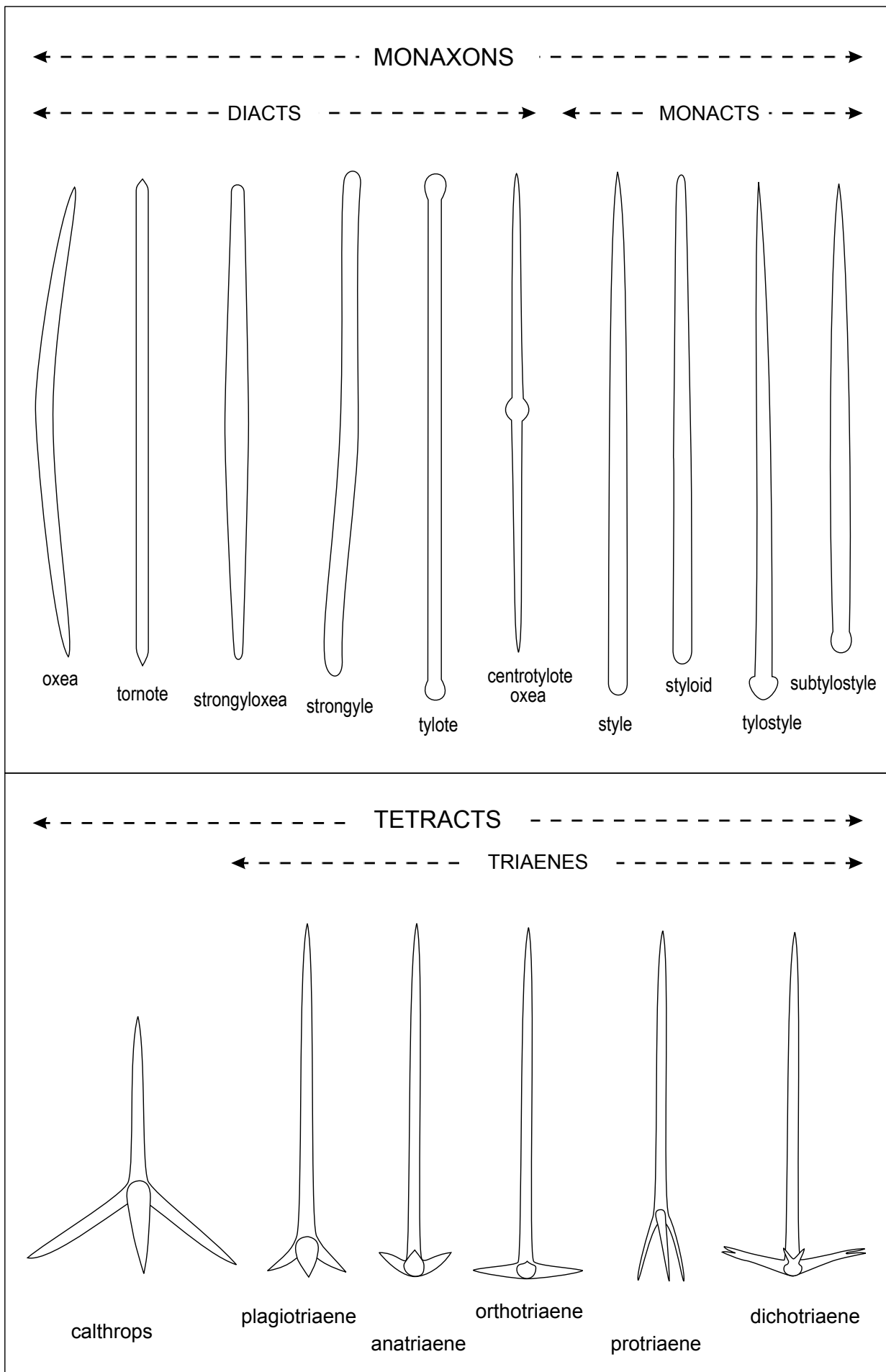

Fig. 1 Demospongiae Megascleres

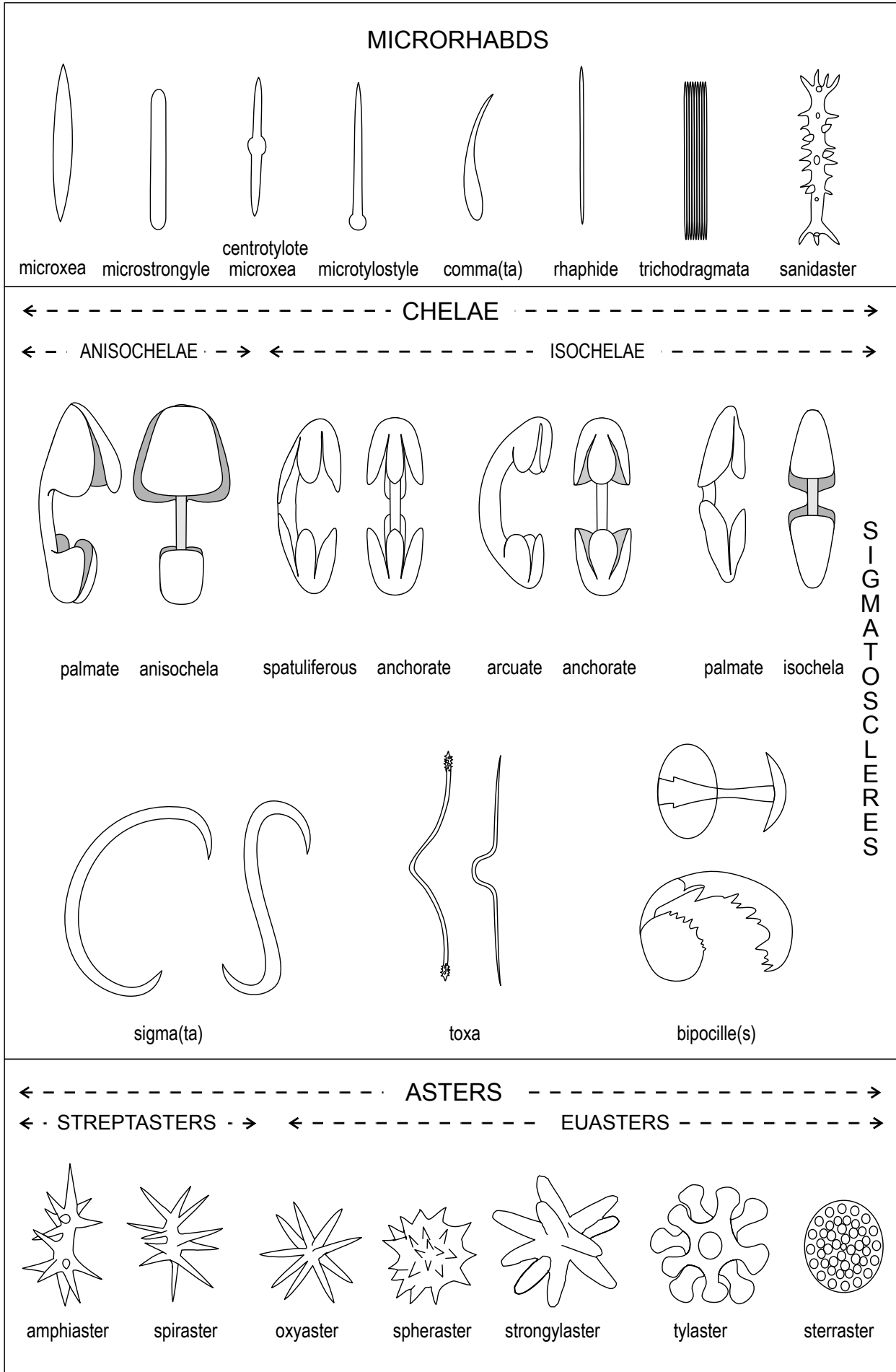
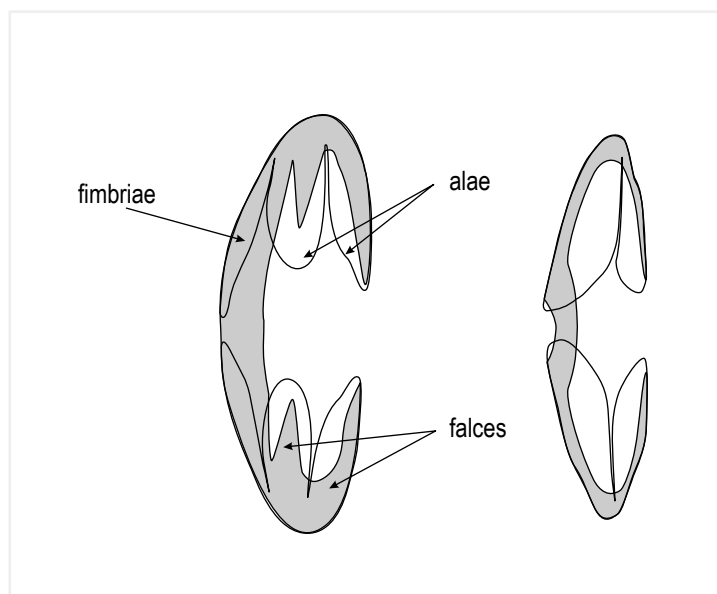

Fig. 2 Demospongiae Microscleres

- Streptoscleres** “A collective term comprising streptasters with the exclusion of sanidaster and its variants” (W.,p.48). See the left of the bottom row on page 15.
- Euasters** “A collective term for astrose microscleres in which the actines radiate from a centre; with or without a centrum” (W.,p.38). See the right of the bottom row on page 15.
- Spheraster** “An euaster with short rays and a thick centrum. The diameter of the centrum exceeds the length of the rays. The rays may be pointed (oxyspheraster), stronglylote (strongylospheraster), or tylote (tylospheraster)” (W.,p.48). See the oxyspheraster on page 15.
- Chelae** The drawings of chelae in this publication have been prepared from Scanning Electron Microscope images, which reveal their true shape. As silica is transparent, however, they often appear to have different shapes under the light microscope. The alae of chelae are very thin, so usually the shape that is seen depends on the angle at which they lie to the microscope. The supporting structures beneath the alae (falces) are usually more obvious because of their thickness.



Chelae as seen with the light microscope

## CLASSIFICATION

### 1. INTRODUCTION

Sponges are sedentary, filter-feeding metazoans which utilize a single layer of flagellated cells (choanocytes) to pump a unidirectional water current through their bodies. In addition, they have epithelial, cellular and skeletal characteristics which set them apart from other phyla, and so are classified in the phylum Porifera. Section 2.1 is a classification scheme for the phylum.

The class Calcarea consists exclusively of marine sponges with a mineral skeleton composed entirely of calcium carbonate. The skeletal spicules are mainly 3 or 4 rayed, and not differentiated into megascleres and microscleres. The Calcarea classification is based on larval, choanocyte and skeletal characteristics. Concentrating on the latter character, Burton (1963) revised the class, reducing the number of then known species from 500 ‘named forms’ to 47. Although Burton’s work excels as a reference document, this excessive ‘lumping’ was not accepted by most spongologists (e.g. Hartman, 1964b), and recent work by Borojevic and others has shown it to be incorrect. Therefore the classification given in section 2.2 is based on a ‘splitting’ philosophy, and the scheme is based on Hartman (1958b). Burton’s names are listed in the right hand column. Of the species sheets in the present text, only one entity (*Scypha ciliata*) is a Burton ‘lump’, the others being ‘named forms’.

The class Demospongiae consists of marine or freshwater sponges with a siliceous skeleton in which megascleres are usually either monaxons or tetraxons (although triaxons are present in the Homoscleromorpha). Microscleres are often (not always) present, and of diverse types. Spongin can be present, supplementing the mineral skeleton either by cementing spicules or by forming fibres. Some genera have lost all specialized skeletal components. Demospongiae classification is based on reproductive patterns, types of larvae, and spicule and skeletal characters. The classification in section 2 is based on *Systema Porifera* Hooper & van Soest (eds.), 2002. The classification of some of the Demospongiae groups is still felt to be unnatural, and will probably undergo some changes in the future as sufficient DNA evidence emerges. The species listed in the classification include all those mentioned in this text (except as synonyms), although inclusion in the list does not necessarily imply validity as a species.

Section 3 contains some introductory notes for guidance on Demospongiae taxa, but these are neither comprehensive nor diagnostic. See *Systema Porifera* for a fuller account. Section 4 consists of eight skeletal drawings as examples of Demospongiae families. Finally, section 5 describes how the difficulties with the “*Haliclonas*” affect this Guide.

## 2. CLASSIFICATION

### 2.1. The Phylum

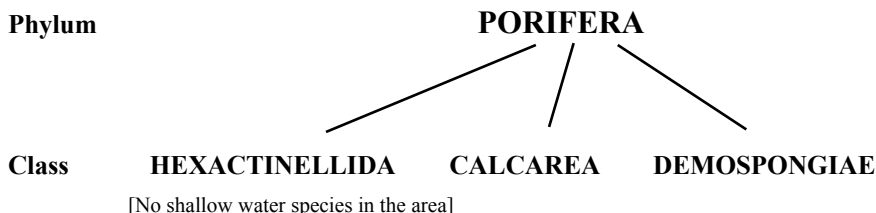

### 2.2 Porifera species reported from Britain and Ireland and the Brittany coast of France

#### CALCAREA

##### CALCINEA

##### CLATHRINIDA

##### Clathrinidae

*Clathrina* Gray, 1867

*clathrus* (Schmidt, 1864)

*contorta* Bowerbank, 1866

*coriacea* (Montagu, 1818)

*primordialis* Haeckel, 1870

*Guancha* Miklucho-Maclay, 1868

*lacunosa* (Bean in Johnston, 1842)

##### Leucaltidae

*Leucaltis* Haeckel, 1872

*impressa* Hanitsch, 1890

##### CALCARONEA

##### LEUCOSOLENIDA

##### Leucosolenidae

*Leucosolenia* Bowerbank, 1861

*botryoides* (Ellis & Solander, 1786)

*complicata* (Montagu, 1818)

*variabilis* Haeckel, 1870

“Named forms” refers in all case to Burton (1963).

*Ascetta clathrus*; *Leucosolenia clathrus* (named form of *Clathrina coriacea*).

*Ascandra contorta*; *Leucosolenia contorta*; (named form of *Clathrina coriacea*).

*Ascetta coriacea*; *Leucosolenia coriacea*.

*Leucosolenia primordialis* (named form of *Clathrina coriacea*).

*Ascortis lacunosa*; *Leucosolenia lacunosa*; *Clathrina lacunosa* (named form of *Clathrina coriacea*).

Named form of *Aphroceras ensata*.

*Ascaltis botryoides* & *Ascandra botrys* of Haeckel, 1872.

*Ascandra complicata* & *Ascandra pinus* of Haeckel, 1872. Named form of *Leucosolenia botryoides*.

*Ascandra variabilis*. Named form of *Leucosolenia botryoides*.

## SYCETTIDA

## Sycettidae

*Sycon* Risso, 1826*ananas* (Montagu, 1818)*ciliata* (Fabricius, 1780)*coronata* (Ellis & Solander, 1786)*elegans* (Bowerbank, 1845)*fistulosa* (Johnston, 1842)*quadrangulata* (Schmidt, 1868)*raphanus* (Schmidt, 1862)*setosa* (Schmidt, 1862)*villosa* (Haeckel, 1870)*Sycandra*; *Scypha*; *Sycortis*.*Leuconia ananas* var. *ananas* (named form of *Scypha ciliata*).*S. ciliata* & *S. coronata* differ primarily in reproductive behaviour. See Tuzet (1973), van Soest et al. (1981).Named form of *Scypha ciliata*.*Grantia tessellata*. Named form of *Scypha ciliata*.*Leuconia fistulosa* of Burton (1963).Named form of *Scypha ciliata*.Named form of *Scypha ciliata*.Named form of *Scypha ciliata*.Named form of *Scypha ciliata*.

## Heteropiidae

*Heteropia* Carter, 1886*ramosa* (Carter in Higgin, 1886)Named form of *Aphroceras ensata*.

## Grantiidae

*Grantia* Fleming, 1828*capillosa* (Schmidt, 1862)*compressa* (Fabricius, 1780)*Scypha* (in part) of Burton (1963).*Sycandra capillosa*; *Scypha capillosa*.*Sycandra compressa*; *Scypha compressa*.*Sycandra* Haeckel, 1872*utriculus* (Schmidt, 1869)Included in *Scypha compressa* by Burton (1963).*Ute* Schmidt, 1862*ensata* (Bowerbank, 1858)*Aphroceras cliarensis* of Stephens (1912); *Aphroceras ensata* of Burton (1963), van Soest et al. (1981); *Leucaltis impressa* of Hanitsch, 1890; *Grantia ensata* Bowerbank.

## Amphoriscidae

*Amphoriscus* Haeckel, 1870*chrysalis* (Schmidt, 1864)*Sycilla chrysalis* of Haeckel, 1872.

## BAERIDA

## Baeriidae

*Leuconia* Grant, 1833*aspera* (Schmidt, 1862)*caminus* (Haeckel, 1870)*gossei* (Bowerbank, 1862)*Leucandra*.Named form of *Aphroceras ensata*.Named form of *Leuconia barbata*.*Aphroceras gossei*; *Leucandra gossei*; *Leucogypsia gossei*. Named form of *Aphroceras ensata*.*Leucandra johnstoni*. Named form of *Leuconia barbata*.*Leucandra nivea*. Included in *Leuconia barbata* by Burton (1963).*Leucaltis punila*. Named form of *Leuconia barbata*.*johnstoni* Carter, 1871*nivea* (Grant, 1826)*pumila* Bowerbank, 1866*Trichogypsia* Carter, 1871*villosa* Carter, 1871*Sycolepis villosa* of Burton (1963).

## DEMOSPONGIAE

## HOMOSCLEROPHORIDA

## Plakinidae

*Oscarella* Vosmaer, 1884*lobularis* (Schmidt, 1862)*Halisarca lobularis* Schmidt, 1862. This species is now considered to be confined to the Mediterranean Sea. British species will probably be given a new name.*rubra* (Hanitsch, 1890)*Plakina* Schulze, 1880*monolopha* Schulze, 1880*Plakortis* Schulze, 1880*simplex* Schulze, 1880*Plakina simplex*

## ASTROPHORIDA

## Pachastrellidae

*Pachastrella* Schmidt, 1868*monilifera* Schmidt, 1868*Characella* Sollas, 1886*pachastrelloides* (Carter, 1876)*Dercitus* Gray, 1867*bucklandi* (Bowerbank, 1858)*Battersbya bucklandi*; *Hymeniacion bucklandi* of Bowerbank*Poecillastra* Sollas, 1869*amygdaloides* (Carter, 1876)*compressa* (Bowerbank, 1866)*Ecionemia compressa* Bowerbank; *Pachastrella compressa* of FMR.*Vulcanella* Sollas, 1886*Sphinctrella* Sollas, 1870

*annulata* (Carter, 1880)  
*ornata* Sollas, 1888

## Theneidae

*Thenea* Gray, 1867  
*muricata* (Bowerbank, 1858)  
*valdiviae* Lendenfeld, 1906

## Ancorinidae

*Stelletta* Schmidt, 1862  
*grubii* Schmidt, 1862

*lactea* Carter, 1871

*Stryphnus* Sollas, 1886  
*ponderosus* (Bowerbank, 1866)  
*Ancorina* Schmidt, 1862  
*radix* Marenzeller, 1889

## Geodiidae

*Pachymatisma* Johnston, 1842  
*johnstonia* (Bowerbank, 1842)  
*normani* Sollas, 1888

*Geodia* Lamarck, 1815  
*atlantica* (Stephens, 1915)  
*cydonium* (Muller, 1798)  
*nodastrella* Carter, 1876  
*pyriformis* (Vosmaer, 1882)

## Thrombidae

*Thrombus* Sollas, 1886  
*abyssi* (Carter, 1873)

## SPIROPHORIDA

## Tetillidae

*Tetilla* Schmidt, 1868  
*cranium* (Muller, 1776)  
*infrequens* (Carter, 1876)  
*polyura* (Schmidt, 1870)  
*truncata* Topsent, 1890  
*zetlandica* (Carter, 1872)

See Steenstrup & Tendal (1982)

May = *Thenea muricata* of Stephens, 1915. Not yet recorded from the area.

*Ecionemia coactura* Bowerbank, 1874; *Tethea collingsii* Bowerbank, 1866; *Tethea schmidtii* Bowerbank, 1866.  
*Myriastra lactea* of FMR; *Pilochrota lactea* of Topsent

*Ecionemia ponderosa*; may = *Stryphnus fortis* (Vosmaer) of Arndt (1935).

*Dragmastra normani* of Arndt (1935)

The following species have frequently been synonymized.  
*Craniella cranium* of FMR; *Tethea/Tethya cranium* of Bowerbank.  
*Tethya cranium* var. *infrequens* of Bowerbank  
*Timea polyura*  
*Timea truncata*  
*Tethya cranium* var. *zetlandica* of Bowerbank

## LITHISTIDA

## Lithistidae

*Macandrewia* Gray, 1859  
*azorica* Gray, 1859

## HADROMERIDA

## Tethyidae

*Tethya* Lamarck, 1814  
*citrina* Sarà & Melone, 1965  
*norvegica* Bowerbank, 1872

*Tethya aurantium* is now thought to be confined to the Mediterranean. Most material from Britain and Ireland is known to be *T. citrina*.

## Suberitidae

*Suberites* Nardo, 1833  
*caminatus* Ridley & Dendy, 1886  
*carnosus* (Johnston, 1842)  
*ficus* (Johnston, 1842)  
*elongatus* Ridley & Dendy, 1886  
*gibbosiceps* Topsent, 1904  
*massa* Nardo, 1847  
*simplex* (Carter, 1876)

See discussion in *Systema Porifera* (page 242).  
*Rhizaxinella elongata*

*Protosuberites* Swartschewsky, 1905  
*durus* Stephens, 1915  
*ectyoninus* Topsent, 1900  
*incrustans* Stephens, 1915  
*rugosus* (Schmidt, 1868)

*Laxosuberites* Topsent, 1896

May = *Protosuberites epiphytum*

*Pseudosuberites* Topsent, 1896  
*fallax* (Bowerbank, 1866)  
*mollis* Topsent, 1925  
*sulphureus* (Bean, 1866)

May = *Hymeniacion perleve* (Burton)

*Terpios* Duchassaing & Michelotti, 1864  
*gelatinosa* (Bowerbank, 1866)  
*Protosuberites* Topsent, 1893  
*epiphytum* (Lamarck, 1815)  
*longispina* Topsent, 1893

*Hymedesmia tenuicula* Bowerbank, 1882; *Terpios fugax* auctt. non D&M, 1864.

*Suberites epiphytum*

*Homaxinella* Topsent, 1916  
*subdola* (Bowerbank, 1866)

*Halichondria subdola* Bowerbank; *Pachaxinella subdola* of Burton (1930)

## Polymastiidae

*Polymastia* Bowerbank, 1862

*Polymastia* species can be difficult to distinguish and attribute names to. See revision by Boury-Esnault.

*agglutinans* Ridley & Dendy, 1886  
*boletiformis* (Lamarck, 1815)  
*conigera* Bowerbank, 1874  
*inflata* Cabioch, 1968  
*penicillus* (Montagu, 1818)

Note spelling. *Polymastia robusta* Bowerbank, 1862

*spinula* Bowerbank, 1866\*

*Polymastia bulbosa* Sara & Siribelli, 1960 non *bulbosa* Bowerbank, 1866  
*Polymastia mamillaris* auctt. non Montagu, 1818. See Morrow & Boury-Esnault, 2000.

*Radiella* Schmidt, 1870  
*sol* Schmidt, 1870

*Quasillina* Norman, 1869  
*brevis* (Bowerbank, 1866)

*Polymastia brevis* Bowerbank

*Tentorium* Vosmaer, 1885  
*semisuberites* (Schmidt, 1870)

*Atergia* Stephens, 1915  
*corticata* Stephens, 1915

*Spinularia* Gray, 1867  
*spinularia* (Bowerbank, 1862)

## Spirastrellidae

*Spirastrella* Schmidt, 1868  
*minax* (Topsent, 1888)

## Clionaidae

*Cliona* Grant, 1826  
*abyssorum* Carter, 1874  
*celata* Grant, 1826  
*levispira* Topsent, 1898  
*lobata* Hancock, 1849  
*pruvoti* Topsent, 1900  
*vastifica* Hancock, 1849

See Rutzler & Stone (1986)

*Raphyrus griffithsii* Bowerbank, 1866; *Vioa celata*

*Alectona* Carter, 1879  
*wallichii* (Carter, 1874)

*Aka* de Laubenfels, 1936  
*coralliophaga* (Stephens, 1915)  
*labyrinthica* (Hancock, 1849)

See Rutzler & Stone (1986)

*Cliona coralliophaga*  
*Cliona labyrinthica*

## Stylocordylidae

*Stylocordyla* Thomson, 1873  
*borealis* (Loven, 1868)

## Timeidae

*Timea* Gray, 1867  
*acutostellata* (Hanitsch, 1894)  
*crassa* (Topsent, 1900)  
*hallezi* (Topsent, 1891)  
*mixta* (Topsent, 1896)  
*stellata* (Bowerbank, 1866)  
*stellifasciata* Sara & Siribelli, 1960

*Hymedesmia hallezi*  
*Hymedesmia mixta*  
*Hymedesmia stellata*

## Hemiassterellidae

*Stelligera* Gray, 1867  
*rigida* (Montagu, 1818)  
*stuposa* (Ellis & Solander, 1786)

*Vibulinus rigidus* of Topsent, 1890.  
*Dictyocylindricus stuposus* of Bowerbank, 1866 *Vibulinus stuposus* of Gray, 1867 & Topsent, 1934

*Adreus* Gray, 1867  
*fascicularis* (Bowerbank, 1866)

*Dictyocylindrus fascicularis* of Bowerbank

*Paratimea* Hallmann, 1917  
*constellata* (Topsent, 1893)

*Bubaris constellata*, *Halicnemia constellata*

## CHONDROSIDA

## Chondrillidae

*Thymosia* Topsent, 1896  
*guernei* Topsent, 1896

## POECILOSLERIDA



## MICROCIONINA

## Raspailiidae

*Raspailia* Nardo, 1833  
*aculeata* (Bowerbank, 1866)  
*hispida* (Montagu, 1818)  
*howsei* (Bowerbank, 1866)  
*pumila* (Bowerbank, 1866)  
*radiosa* (Bowerbank, 1866)  
*ramosa* (Montagu, 1818)  
  
*rectangula* (Bowerbank, 1874)  
*ventilabrum* (Bowerbank, 1866)  
  
*viminalis* Schmidt, 1862  
*virgultosa* (Bowerbank, 1866)

*Endectyon* Topsent, 1920  
*delaubenfelsi* Burton, 1930  
*demonstrans* (Topsent, 1892)  
*teissieri* Cabioch, 1968

*Eurypon* Gray, 1867  
*clavatum* (Bowerbank, 1866)  
*coronula* (Bowerbank, 1869)  
*lacazei* (Topsent, 1891)  
*major* Sara & Siribelli, 1960  
*radiata* Bowerbank, 1866  
*simplex* (Bowerbank, 1874)  
*viride* (Topsent, 1889)

*Hymeraphia* Bowerbank, 1862  
*stellifera* (Bowerbank, 1866)

## Rhabderemiidae

*Rhabderemia* Topsent, 1890  
*guernei* Topsent, 1890  
*minutula* (Carter, 1876)

## Microcionidae

*Clathria* Schmidt, 1862  
*anchorata* (Carter, 1874)  
*barleei* (Bowerbank, 1866)  
  
*coralloides* (Olivi, 1792)

*Artemisina* Vosmaer, 1885  
*arciger* (Schmidt, 1870)  
*hispanica* Ferrer-Hernandez, 1919  
*transiens* Topsent, 1892

*Ophlitaspongia* Bowerbank, 1866  
*papilla* (Bowerbank, 1866)  
*kildensis* Howson & Chambers, 1999

*Clathria* (*Microcionia*) Bowerbank, 1862  
*acanthotoxa* (Stephens, 1916)  
*armata* (Bowerbank, 1866)  
*ascendens* (Cabioch, 1968)  
*atrasanguinea* (Bowerbank, 1862)  
*ditoxa* (Stephens, 1916)  
*elliptichela* (Alander, 1942)  
*fallax* (Bowerbank, 1866)  
*gradalis* (Topsent, 1925)  
*laevis* (Bowerbank, 1866)  
*macrochela* (Levi, 1960)  
*microchela* (Stephens, 1916)  
*osismica* (Cabioch, 1968)  
*spinarcus* (Carter & Hope, 1889)  
*strepsitoxa* (Carter & Hope, 1889)  
*tenuissima* (Stephens, 1916)  
*toximajor* (Topsent, 1925)  
*toxitenuis* (Topsent, 1925)

*Antho* (*Antho*) Gray, 1867  
*brattegardi* van Soest & Stone, 1986  
*dichotoma* (Esper, 1794)  
*involvens* (Schmidt, 1864)  
  
*inconstans* Topsent, 1925

See Ackers *et al.* (1985) p.111

*Dictyocylindrus hispidus* of Bowerbank, 1866; non *Spongia hispida* Lamarck, 1814

*Dictyocylindrus radiosus*  
*Dictyocylindrus ramosus* of Bowerbank, 1866; may = *Raspailia pumila* (Bowerbank, 1866). This species has in the past been synonymised with *R. hispida*.

*Dictyocylindrus ventilabrum*. See Cabioch (1968) for distinguishing characters separating it from *R. hispida*.

*Dictyocylindrus virgultosus* Bowerbank, 1866

*Hymeraphia clavata* Bowerbank  
*Hymeraphia coronula* Bowerbank  
*Hymeraphia lacazei* Topsent

incorrectly placed in *Hymedesmia* by some authors  
*Hymeraphia simplex* Bowerbank  
*Tricheurypon viride* (Topsent, 1889)

*Mesapos stellifera* of Topsent, 1900

*Rhabderemia pusilla* (Carter)

= Clathriidae  
See van Soest & Stone (1986)

*Clathria foliata* (Bowerbank, 1874); *Halichondria foliata*; Bowerbank *Isodictya lacinoso* Bowerbank

May = *Rhaphidoplus* Ehlers, 1870

May = *Artemisina transiens*

*Ophlitaspongia seriata* non Grant, 1826, auctt.

*Eurypon acanthotoxa* Stephens

*Plumohalichondria atrasanguinea* of Hanitsch, 1890

Recently discovered in the British Isles (BEP)

*Clathria gradalis* Topsent

*Clathria toxitenuis* Topsent

Not yet recorded from the area  
*Dictyoclathria dichotoma* (Esper)  
*Dictyoclathria beanii* of Burton, 1933 & Arndt, 1935; *Isodictya beanii* Bowerbank, 1866; *Myxilla involvens* Schmidt now considered distinct from *A. involvens*.

SPONGES OF THE BRITISH ISLES

*Antho* (*Acarnia*) Gray, 1867  
*erecta* (Ferrer-Hernandez, 1921)  
*circonflexa* Levi, 1960  
*coriacea* (Bowerbank, 1874)

= *Plocamilla* Topsent, 1928

MYXILLINA

Chondropsidae

*Batzella* Topsent, 1893  
*inops* (Topsent, 1891)

*Halichondria inops* Topsent

Coelosphaeridae

*Inflatella* Schmidt, 1875  
*pellicula* Schmidt, 1875

*Forcepia* Carter, 1874  
*forcipis* (Bowerbank, 1866)  
*fragilis* Stephens, 1917

*Halichondria forceps* of Bowerbank

(*Leptolabis*) Topsent, 1904  
*luciensis* (Topsent, 1888)

*Dendoryx luciensis* Topsent, 1888

*Lissodendoryx* Topsent, 1892  
*diversichela* Lundbeck, 1905  
*fragilis* (Fristedt, 1885)  
*lundbecki* Topsent, 1913  
*stipitata* (Arnesen, 1903)

*Ectyodoryx* Lundbeck, 1909  
*atlanticus* Stephens, 1916  
*foliata* (Fristedt, 1887)

Desmacididae

*Desmacidon* Bowerbank, 1861  
*fruticosum* (Montagu, 1818)

Tedaniidae

*Tedania* Gray, 1867  
*suctoria* Schmidt, 1870

Myxillidae

*Myxilla* Schmidt, 1862  
*fimbriata* (Bowerbank, 1864)  
 cf. *fimbriata* (Bowerbank, 1864)  
*incrustans* (Johnston, 1842)  
*perspinosa* Lundbeck, 1905  
*rosacea* (Lieberkuhn, 1859)  
 cf. *rosacea* (Lieberkuhn, 1859)  
*ancoratum* Cabioch, 1968

= *Styloptilon* Cabioch, 1968; A number of undescribed entities exist  
*Isodictya fimbriata* Bowerbank, 1864; *Isodictya lurida* Bowerbank, 1866

*Dendoryx incrustans* of Gray, 1867; *Halichondria incrustans* of Bowerbank

See Ackers *et al.* (1985)  
*Styloptilon* reduced to subgenus of *Myxilla*

*Melonanchora* Carter, 1874  
*elliptica* Carter, 1874  
*emphysema* (Schmidt, 1875)

*Ectoforcepia* Cabioch, 1968  
*psammophila* Cabioch, 1968

*Iophon* Gray, 1867  
*nigricans* (Bowerbank, 1858)

*Halichondria nigricans* Bowerbank; may = *Menyllus nigricans* of Gray, 1867 & IOM

*pattersoni* (Bowerbank, 1858)

May = *nigricans*, although this may well be a valid species of *Iophon*

*hyndmani* (Bowerbank, 1858)

= *Halichondria hyndmani* Bowerbank, 1858; *H. ingalli* Bowerbank, 1866

*piceus* (Vosmaer, 1882)  
*spinulentum* (Bowerbank, 1866)

*Plocamiancora* Topsent, 1928  
*arndti* Alander, 1942

Recently discovered in the British Isles (BEP)

Iotrochotidae

*Iotrochota* Ridley, 1884  
*abyssi* (Carter, 1874)  
*acanthostylifera* Stephens, 1916

*Hymetrochota* Topsent, 1904  
*topsenti* Burton, 1930

*Hymenotrocha* of Burton (misprint).

Hymedesmiidae

*Hymedesmia* Bowerbank, 1862  
*baculifera* (Topsent, 1901)

Difficult taxonomic group at present undergoing revision

- brondstedii* Burton, 1930
- crux* (O.Schmidt, 1875)  
*curvichela* Lundbeck, 1910  
*digitata* Lundbeck, 1910  
*helgae* Stephens, 1916  
*hibernica* Stephens, 1916  
*koehleri* (Topsent, 1896)  
*lenta* Descatoire, 1966  
*lieberkuhni* Burton, 1930
- longistylus* Lundbeck, 1910  
*mucronota* (Topsent, 1904)  
*mutabilis* (Topsent, 1904)  
*nummulus* Lundbeck, 1910  
*occulta* Bowerbank, 1869  
*pansa* Bowerbank, 1882  
*paupertas* (Bowerbank, 1866)
- peachii* Bowerbank, 1882  
*pilata* Bowerbank, 1882  
*primitiva* Lundbeck, 1910  
*procumbens* Lundbeck, 1910  
*similis* Lundbeck, 1910  
*spinosa* Stephens, 1916  
*stephensi* Burton, 1930  
*truncata* Lundbeck, 1910  
*veneta* (Schmidt, 1862)  
*versicolor* (Topsent, 1893)  
*zetlandica* Bowerbank, 1862
- Spanioplion* Topsent, 1890  
*armaturum* (Bowerbank, 1866)
- Phorbas* Duchassaing & Michelotti, 1864  
*ficitius* (Bowerbank, 1866)
- perarmatus* (Bowerbank, 1866)  
*bihamigera* (Waller, 1878)  
*dendyi* (Topsent, 1892)  
*dives* (Topsent, 1891)  
*microcheliferum* (Cabioch, 1968)  
*microcionides* (Carter, 1876)  
*plumosum* (Montagu, 1818)
- Plocamionida* Topsent, 1927  
*ambigua* (Bowerbank, 1866)  
*microcionides* (Carter, 1876)
- Hemimycalca* Burton, 1934  
*columella* (Bowerbank, 1874)
- Crellidae  
*Crella* Gray, 1867  
*albula* (Bowerbank, 1866)  
*digitifera* (Levi, 1959)  
*elegans* (Schmidt, 1862)  
*polymastia* (Thiele, 1903)  
*pyrula* (Carter, 1876)  
*rosea* (Topsent, 1892)
- MYCALINA  
Mycalidae  
*Mycalca* Gray, 1867  
*contarenii* (Martens, 1824)
- lingua* (Bowerbank, 1858)  
*macilenta* (Bowerbank, 1866)  
*massa* (Schmidt, 1862)  
*micracanthoxea* Buizer & van Soest, 1977  
*minima* (Waller, 1880)  
*placoides* (Carter, 1876)  
*retifera* Topsent, 1924  
*rotalis* (Bowerbank, 1874)  
*similaris* (Bowerbank, 1874)
- Rhaphidotheca* Kent, 1870  
*marshallhalli* Kent, 1870
- Anchinoe coriaceous* of Topsent, 1936; *Dendoryx dujardini* (Bowerbank, 1866) of Topsent, 1888; *Stylopus dujardini* of Levinsen, 1887 & Arndt, 1935; nec *Halisarca dujardini* Johnston, 1842
- New name for *Halichondria fasciculata* Lieberkuhn, 1859 & *Myxilla fasciculata* Schmidt, 1862; nec *Spongia fasciculata* Pallas, 1766
- Anchinoe paupertas*; (although in the Mediterranean this name is used for a species of *Phorbas*); *Hymeniacion paupertas* Bowerbank
- Lough Hyne see Lilly *et al.* (1953)
- May = *Spanioplion armaturum* (Bowerbank) q.v.
- May = *Hymedesmia stephensi* Burton q.v.
- = *Stylostichon* Topsent, 1892; *Pronax* Gray, 1867  
*Anchinoe ficitius* of Stephens, 1921 & FMR; *Microcionia ficitia* Bowerbank *Plumohalichondria ficitia* of Hanitsch, 1894
- Microcionia dives* Topsent; *Pronax dives*
- Microcionia plumosa* of Parfitt, 1868; *Plumohalichondria plumosa* of Carter, 1885; *Pronax plumosa* of Gray, 1867
- Microcionia ambigua*
- Familial placing being reviewed (Ackers *et al.*, 1985)  
*Desmacidon columella* Bowerbank; *Stylorella columella* of Topsent, 1894
- Pytheas* Topsent, 1890
- Southern species not recorded from the area
- Yvesia rosea* Topsent
- Desmacidon copiosa* Bowerbank; *Esperia modesta* of Arndt, 1935; *Halichondria aegagropila* Bowerbank; *Mycalca intermedia* (Schmidt, 1870)  
*Rhaphioderma lingua* of Bowerbank, 1874  
Subgenus *Carmia*; *Hymeniacion macilenta* Bowerbank
- Considered synonymous with *M. lingua* by some authors.
- Subgenus *Aegagropila*; *Desmacidon rotalis* Bowerbank  
*Desmacidon similaris* Bowerbank; *Esperella sordida* of Delage, 1892; *Rhaphioderma sordida*; Bowerbank; *Mycalca subclavata* of PMF
- Rhaphidotheca rhopalophora* (Schmidt, 1875)

## Cladorhizidae

*Cladorhiza* M.Sars, 1869  
*abyssicola* Sars, 1872  
*Asbestopluma* Topsent, 1901  
*pennatula* (Schmidt, 1875)

Cladorhizids have now been shown to be carnivorous sponges, living mostly in deep water and lacking choanocytes. They feed by entangling and engulfing small polychaetes and crustaceans.

## Hamacanthidae

*Hamacantha* Gray, 1867  
*falcula* (Bowerbank, 1869)  
*johnsoni* (Bowerbank, 1862)

## Desmacellidae

*Biemna* Gray, 1867  
*variantia* (Bowerbank, 1858)

*Biemna peachii* (Bowerbank, 1866); *Desmacella capillifera* of Lundbeck, 1902;  
*Hymeniacion variantia* Bowerbank

*Desmacella* Schmidt, 1870  
*annexa* (Schmidt, 1870)  
*informis* Stephens, 1916  
*inornata* (Bowerbank, 1866)

*Sigmatoxella annexa* of FMR; *Tylodesma annexa*  
*Tylodesma informis*  
*Tylodesma inornata*

## Esperiopsidae

*Amphilectus* Vosmaer, 1880  
*fucorum* (Esper, 1794)  
*lobata* (Montagu, 1818)  
*ovulum* (Schmidt, 1870)

Includes Desmacidoninae

*Esperiopsis fucorum* of FMR; *Isodictya edwardii*;  
*Corybas lobata* (Montagu, 1818)  
 ? = *lobata*

*Esperiopsis* Carter, 1882  
*incognita* Stephens, 1916  
*macrosigma* Stephens, 1916  
*schmidtii* Arnesen, 1903  
*villosa* (Carter, 1874)

## Guitarridae

*Guitarra* Carter, 1874  
*fimbriata* Carter, 1874

## Isodictyidae

*Isodictya* Bowerbank, 1858  
*palmata* (Ellis & Solander, 1786)

May belong in the Haplosclerida (BEP).

## LATRUNCULINA

*Latrunculia* Barboza du Bocage, 1869  
*cratera* Barboza du Bocage, 1869  
*normani* Stephens, 1915  
*triloba* (Schmidt, 1875)

## HALICHONDRIDA

## Axinellidae

*Axinella* Schmidt, 1862  
*agnata* Topsent, 1896  
*arctica* Vosmaer, 1885  
*damicornis* (Esper, 1794)  
*dissimilis* (Bowerbank, 1866)

See Ackers *et al.* (1985)

*Axinella cinnamomea* of Schmidt, 1862  
*Axinella dissimilis* of FMR; *Isodictya dissimilis* Bowerbank, 1866; *Halichondria distorta* Bowerbank, 1866; non *Axinella polypoides* (Schmidt, 1862) (now considered to be a separate species confined to the Mediterranean); *Tragosia polypoides* of Stephens, 1917

*egregia* (Ridley, 1881)  
*flustra* Topsent, 1892  
*infundibuliformis* (Linnaeus, 1758)

*Tragosia flustra* of Topsent

*Isodictya infundibuliformis* of Bowerbank *Tragosia infundibuliformis* of Arndt (1935)

*mammillata* (Hanitsch, 1890)  
*microdragma* (Lendenfeld, 1897)  
*multiformis* (Vosmaer, 1885)  
*pocillum* (Bowerbank, 1866)  
*pyramidata* Stephens, 1916  
*thielei* (Topsent, 1898)  
*verrucosa* (Esper, 1794)

*Phakellia* Bowerbank, 1862  
*robusta* Bowerbank, 1866  
*rugosa* (Bowerbank, 1862)  
*setosa* (Bowerbank, 1873)  
*ventilabrum* (Linnaeus, 1767)

*Axinella rugosa* of Arndt; *Dictyocylindricus rugosus* Bowerbank

## Bubaridae

*Bubaris* Gray, 1867  
*vermiculata* (Bowerbank, 1862)

*Phakellia vermiculata*; *Hymenaphia vermiculata* Bowerbank

- Hymerhabdia* Topsent, 1892  
*intermedia* Sara & Siribelli, 1960  
*typica* Topsent, 1892  
*Monocrepidium* Topsent, 1898  
*minuta* Cabioch, 1968
- Desmoxyiidae  
*Halicnemia* Bowerbank, 1862  
*patera* Bowerbank, 1862  
*verticillata* (Bowerbank, 1862)  
*Higginsia* Higgin, 1877  
*strigilata* (Lamarck, 1813)
- Halichondriidae  
*Halichondria* Fleming, 1828  
*agglomerans* Cabioch, 1968  
*bowerbanki* Burton, 1930  
*difficilis* Lundbeck, 1902  
*membrana* (Bowerbank, 1866)  
*panicea* (Pallas, 1766)
- topsenti* de Laubenfels, 1936
- Ciocalypta* Bowerbank, 1862  
*penicillus* Bowerbank, 1864
- Eumastia* Schmidt, 1870  
*appendiculata* Schmidt, 1875  
*sitiens* Schmidt, 1870
- Pseudaxinyssa* Burton, 1931  
*digitata* Cabioch, 1968
- Spongosorites* Topsent, 1896  
*fibrosa* (Fristedt, 1887)  
*genitrix* (Schmidt, 1870)  
*glabra* (Topsent, 1904)
- Vosmaeria* Fristedt, 1885  
*crustacea* Fristedt, 1885  
*laevigata* Topsent, 1896
- Hymeniacionidae  
*Hymeniacion* Bowerbank, 1858  
*caruncula* Bowerbank, 1857  
*perleve* (Montagu, 1818)  
*sanguinea* (Grant, 1826)
- kitchingi* Burton, 1935
- Ulosa* de Laubenfels, 1936  
*digitata* (Schmidt, 1866)
- Dictyonellidae  
*Dictyonella*  
*incisa* (Schmidt, 1880)
- Tethyspira* Topsent, 1890  
*spinosa* (Bowerbank, 1874)
- HAPLOSCLERIDA  
HAPLOSCLERINA  
Chalinidae Haliclonaidae.  
*Haliclona* Grant, 1835
- Haliclona* (Haliclona)  
*cinerea* (Grant, 1826)  
*oculata* (Pallas, 1766)  
*simulans* (Johnston, 1842)  
*urceolus* (Rathke & Vahl, 1806)  
*viscosa* (Topsent, 1888)  
*Haliclona* (Gellius) Gray, 1867  
*angulata* (Bowerbank, 1866)  
*fibulata* (Schmidt, 1862)  
*rava* (Stephens, 1912)  
*Haliclona* (*Halichoclona*) de Laubenfels, 1932
- Skeizia* Cabioch, 1968
- Crella inflata* Bowerbank of Arndt (1935)  
*Bubaris gallica* of Topsent, 1893
- This genus requires revision
- Halichondria coalita* (Lamouroux, 1876) of Bowerbank, 1866  
*Topsentia difficilis*; *Spongosorites difficilis*
- a very polymorphic species, currently under review. Some of the many older forms may be reestablished, particularly where they refer to distinctive forms, to facilitate the collection of information (Ackers *et al.*, 1985).  
*Hymeniacion reticulatus* (Bowerbank, 1866)
- Topsentia* Berg, 1899
- Halichondria glabra* of IOM
- Bergquist (1980a) considers that this family remains a problem, with some genera showing strong biochemical affinities with the Hadromerida.  
These three species may all be synonymous, but more information is required. Separate ecological entities are recognisable, so the 3 species are retained as separate here. See Ackers *et al.* (1985), van Soest & Weinberg (1980).
- Desmacidon pannosus* Bowerbank *Halichondria inornata* Bowerbank *Ulosa tupha* (Pallas, 1776)
- Tethea spinosa* Bowerbank
- Revised by de Weerd (1985, 1986). See also Griessinger (1971), van Soest (1980).
- See de Weerd (1986)  
The species of *Haliclona* given here follow de Weerd (1986) although it is likely that there are a number of other species in the British Isles as yet unattributable to any of the following. (BEP).
- Ackers *et al.*, (1985) *Haliclona* 'W', 'F', 'C'.  
Ackers *et al.*, (1985) photos 36, 38  
Ackers *et al.*, (1985) photos 38, 39  
Stalked, tubular *Haliclona* of Ackers *et al.* (1985) photos 90, 91; *Haliclona* 'M'  
Ackers *et al.* (1985) photos 93, 100, 101 *Haliclona* 'B', 'J', possibly 'A'.

## SPONGES OF THE BRITISH ISLES

*fistulosa* (Bowerbank, 1866)  
*Haliclona* (*Rhizoniera*) Griessinger, 1971  
*indistincta* (Bowerbank, 1866)  
*rosea* (Bowerbank, 1866)  
*Haliclona* (*Soestella*) de Weerd, 2000  
*xena* de Weerd, 1986

*Chalinula* Schmidt, 1868  
*limbata* (Montagu, 1818)  
*loosanoffi* (Hartman, 1958)

### PETROSINA

#### Phloeodictyidae

*Oceanapia* Norman, 1869  
*robusta* (Bowerbank, 1866)  
*isodictyiformis* (Carter, 1882)

Ackers *et al.*, (1985) photos 96, 98, 99; *Haliclona* 'E', 'G', 'H'.

Known only from type area in the Netherlands possibly an introduction.

*Acervochalina* Ridley, 1884  
*Chalina limbata*; *Haliclona limbata* auctt.  
*Haliclona loosanoffi*

### DICTYOCERATIDA

#### Dysideidae

*Dysidea* Johnston, 1842  
*avara* (Schmidt, 1862)  
*fragilis* (Montagu, 1818)  
*pallescens* Schmidt, 1862  
*Spongionella* Bowerbank, 1862  
*pulchella* (Sowerby, 1806)

*Spongelia fragilis* of Lendenfeld

### DENDROCERATIDA

#### Darwinellidae

*Aplysilla* Schulze, 1878  
*rosea* (Barrois, 1876)  
*sulfurea* Schulze, 1878

Bergquist (1980b) considers colour to be a stable specific character in this family, and that variation from rose to yellow within one species would not occur. Other authors, however, consider the two species synonymous. (See also Ackers *et al.*, 1985).

*Chelonaplysilla* De Laubenfels, 1948  
*noevus* (Carter, 1876)

### HALISARCIDA

#### Halisarcidae

*Halisarca* Dujardin, 1838  
*dujardini* Johnston, 1842  
*metschnikovi* Levi, 1953

non *Hymeniacidon dujardini* Bowerbank, 1866

### VERONGIDA

#### Aplysinidae

*Aplysina* Nardo, 1834  
*zetlandica* (Bowerbank, 1866)

#### Ianthellidae

*Hexadella* Topsent, 1896  
*racovitzai* Topsent, 1886

### 3. DEMOSPONGIAE CLASSIFICATION NOTES

(The approximate number of British species is shown in brackets, and probably errs on the high side. An asterisk (\*) indicates a skeletal drawing in section 4).

**HOMOSCLEROPHORIDA (4)** No skeleton, or simple skeleton with triactines.

**ASTROPHORIDA (21)** See below for table

**SPIROPHORIDA (5)** of families.

Family	Triactines	Calthrops	Euasters	Sterrasters	Streptasters	Amphiasters	Sigmataspores
PACHASTRELLIDAE (7)	no	yes			yes		
THENEIDAE (2)	yes				yes		
ANCORINIDAE (4)	yes		yes	no			
GEODIIDAE (6)	yes			yes			
THROMBIDAE (1)	yes					yes	
TETILLIDAE (5)	yes						yes/no

#### HADROMERIDA (53)

**CHONDROSIIDAE (1)**

No megascleres. Collagen cortex. Euasters.

**TETHYIDAE (1)**

Spherical sponges. Radial skeleton. Large strongyloxea and asters.

**SUBERITIDAE (17)**

Tylostyles. Palisade at surface, jumbled interior.

**POLYMASTIIDAE (11)**

Radial spicule fibres. Palisade at surface. Oscular and pore-bearing papillae present.

**SPIRASTRELLIDAE (1)**

Tylostyles, spirasters. Not boring.

**CLIONAIDAE (6)**

Boring sponges. Tylostyles, spirasters. Special inhalent papillae present.

**STYLOCORDYLIDAE (1)**

Deep water. Globular body and long stalk.

**HEMIASTERELLIDAE (3)**

Branching axinellids with euasters, usually in subsurface layer. Dermal spicule brushes.

**TIMEIDAE (6)**

Encrusting. Tylostyles, euasters.

#### POECILOSCLERIDA (130)

Styles or acanthostyles form main skeleton. Chelae or sigmata usually present.

**MICROCIONINA (48)**

**RASPAILIIDAE (15)\***

Similar to Hemiasterellidae, but acanthostyles as microscleres.

**RHABDEREMIIDAE (2)**

Rhabdostyles as megascleres.

**MICROCIONIDAE (31)\***

Styles or acanthostyles in plumose or plumoreticulate skeletons, which may be echinated by smaller acanthostyles. Surface skeleton of fine styles or subtylostyles. Isochelae are palmate, usually small. Toxa frequently present.

**MYXILLINA (70)**

**COELOSPHAERIDAE (2)**

Deep water. Soft, plumoreticulate skeleton.

**TEDANIIDAE (1)**

Plumoreticulate skeleton of styles. Microscleres onychaetes.

**MYXILLIDAE (25)\***

Main skeleton of acanthostyles or styles. Surface layer of tornotes. Microscleres chelae, and sometimes sigmata, bipocilles, etc.

**HYMEDESMIIDAE (29)\***

Thin crusts. Acanthostyles echinating substratum. Tornotes, etc. form body/surface skeleton. Chelae usually present.

**DESMACIDONIDAE (2)**

Reticulate skeleton of oxea. Microscleres sigmata and chelae.

**CRELLIDAE (7)**

Characteristic surface layer of acanthostyles forming dense crust. Interior of plumoreticulate tracts of diactines.

**MYCALINA (23)**

**MYCALIDAE (11)**

Plumoreticulate skeleton of styles or subtylostyles. Anisochelae which may form rosettes. Many types of microscleres.

**CLADORHIZIDAE (2)**

Deep water. Styles and anisochelae.

**HAMACANTHIDAE (2)**

Diancistras as microscleres.

**BIEMNIDAE (4)**

Reticulate skeleton of styles. Abundant raphides and commata.

**ESPERIOPSISIDAE (11)**

Skeleton of styles. Chelae as microscleres.

**LATRUNCULINA (3)**

**LATRUNCULIIDAE (3)**

Dermal crust of discorhabd microscleres. Deep water.

<b>HALICHONDRIDA (21)</b>	Disordered skeletons.
<b>AXINELLIDAE (23)</b>	Axial skeleton of oxea, strongyles or styles, with softer plumose extra-axial skeleton. No microscleres other than raphides.
<b>BUBARIDAE (4)</b>	Thinly encrusting, strongly hispid due to erect monactinal spicules with heads embedded in a basal layer of interlacing megascleres.
<b>DESMOXIIDAE (3)</b>	Microscleres are smooth or spined microxea or microstrongyles. Megascleres may be very large oxea, styles or strongyles.
<b>HALICHONDRIIDAE (21)</b>	Skeletons of oxea, styles or both, skeleton disordered with an organised ectosomal skeleton.
<b>DICTYONELLIDAE (3)</b>	Skeletons of long styles, with fleshy organic ectosomal layer.
<b>HAPLOSCLERIDA (16)*</b>	Skeleton isodictyal network of oxea. Microscleres may be present - toxa or sigmata. Taxonomy confused at family, genus and species level. See section 5, The 'Haliconas'.
<b>DICTYOCERATIDA (3)</b>	No spicules. Anastomosing spongin fibre skeleton.
<b>DENDROCERATIDA (3)</b>	
<b>APLYSILLIDAE (2)</b>	Skeleton of spongin fibres arranged in a dendritic pattern.
<b>HALISARCIDAE (2)</b>	No skeleton.
<b>VERONGIDA (1)</b>	Reduced spongin skeleton supporting a heavily collagenous matrix.

#### 4. The 'Haliconas'

It has become apparent that whilst the taxonomy of the Haplosclerid group of sponges known loosely as 'the *Haliconas*' is at present ill-defined they form a common and conspicuous element of the sublittoral sponge fauna. There are a number of distinct forms which are fairly recognizable underwater, but whose spicule and skeletal morphology is so similar that there are problems in assigning specific names to them. Since the publication of *Sponge III* some progress has been made and, with the help of Dr. W. de Weerd of the Institute of Taxonomic Zoology, University of Amsterdam, The Netherlands, we feel able to give tentative names to many of the entities which were previously lumped under *Haliconas* spp. See publications by de Weerd in the bibliography. The situation is still fluid and we are continuing to encourage the gathering of information about this group of sponges. Please collect specimens of these and any other distinctive examples of the group, and record descriptive and ecological data on a *Sponge Project* recording form. We emphasize that progress depends on the aggregation of more comprehensive records of the group. Photographs of the living sponge, *in situ* and/or in a dish of seawater, add greatly to the value of the records, as the taxonomic difficulties with this group of sponges stems largely from their similar spicules and skeletons. External form, in contrast, is varied and often distinctive. Specimens and information are needed from as many different sites as possible, and two or three different specimens or growth forms should be recorded at each site. (Don't always remove all of a specimen - bear conservation in mind.)

There are a number of important points which should be given particular attention when recording a given specimen:

1. Check whether the surface layer (ectosome) is easily peeled off. Start by separating the surface from the underlying tissue with a scalpel, then try to peel it back with forceps. Note result.
2. Observe the pore-like structure of the surface. Make a sketch if possible or take a close-up photograph.
3. Take particular note of the distribution and shape of the oscules. Sketches will help.
4. Note any reproductive features of the specimen.
  - (a) Presence of eggs (thin-walled balls enclosing immature spicules).
  - (b) Colour of eggs if present.
  - (c) Presence of gemmulae (resistant overwintering structures found at the base of the sponge which contain mature spicules).
5. Whenever possible dry a piece of the specimen on a glass plate or microscope slide over a radiator - a portion 1-2 cm in diameter including an osculum and surface tissue is ideal. Do not rinse in fresh water or attempt to preserve before drying. Store it with a number to link with the rest of specimen in alcohol - matchboxes can be used for storage.

Haplosclerids are easily recognised under the microscope by their main skeleton of oxea usually being arranged in a regular reticulate pattern with fibres of parallel spicules and considerable amounts of spongin. In some species, e.g. *Haliconas limbata* (Montagu 1818) the spongin fibres completely enclose the spicules. Some genera have microscleres, usually sigmata or toxa. *Halichondria* also has a skeleton of oxea but these are relatively longer and thinner than those of Haplosclerids and are arranged in a haphazard fashion, crisscrossing each other densely. Tangential sections near the surface will show these differences most clearly.

Specimens and completed forms should be sent to B.E. Picton, Dept. of Botany and Zoology, Ulster Museum, Botanic Gardens, Belfast, BT9 5AB, who will act as a clearing house for information.



5. DEMOSPONGIAE SKELETON DRAWINGS

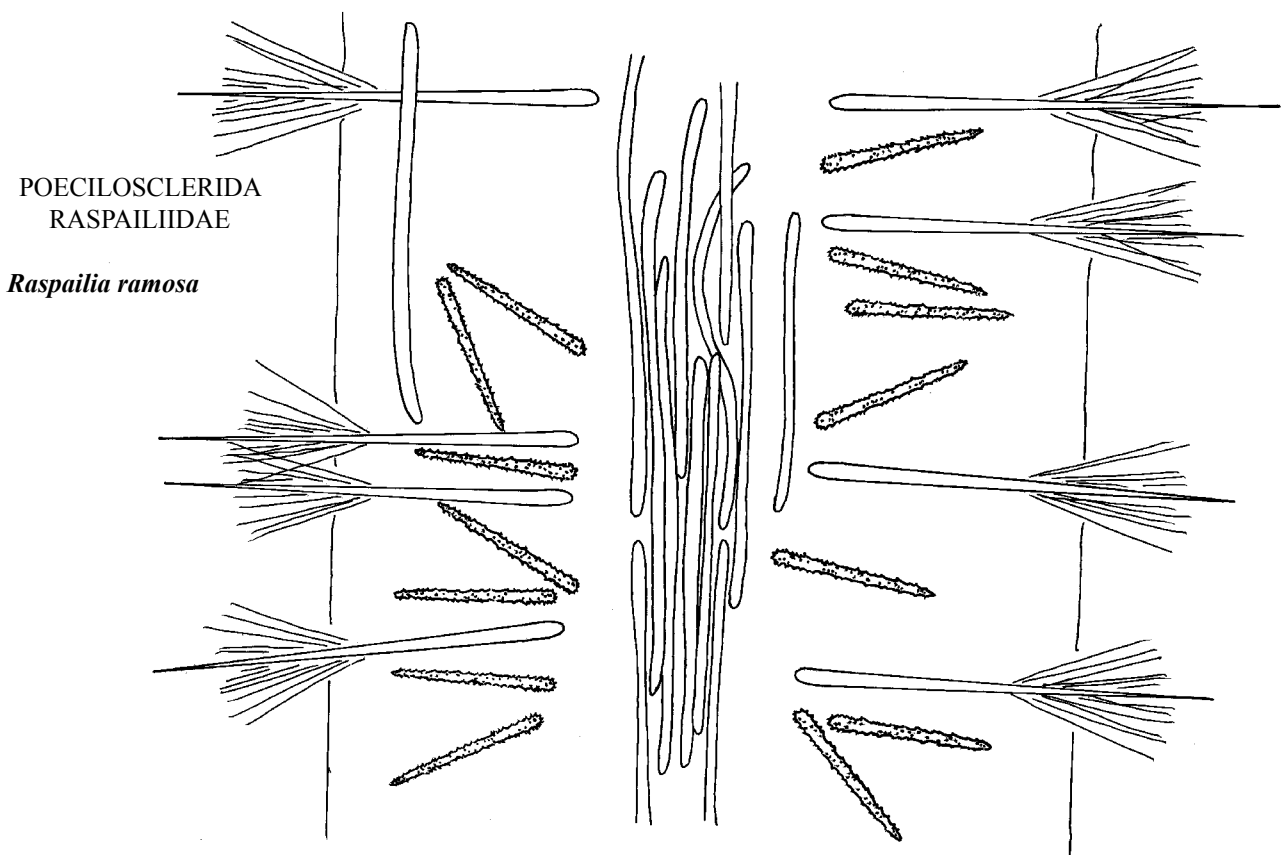
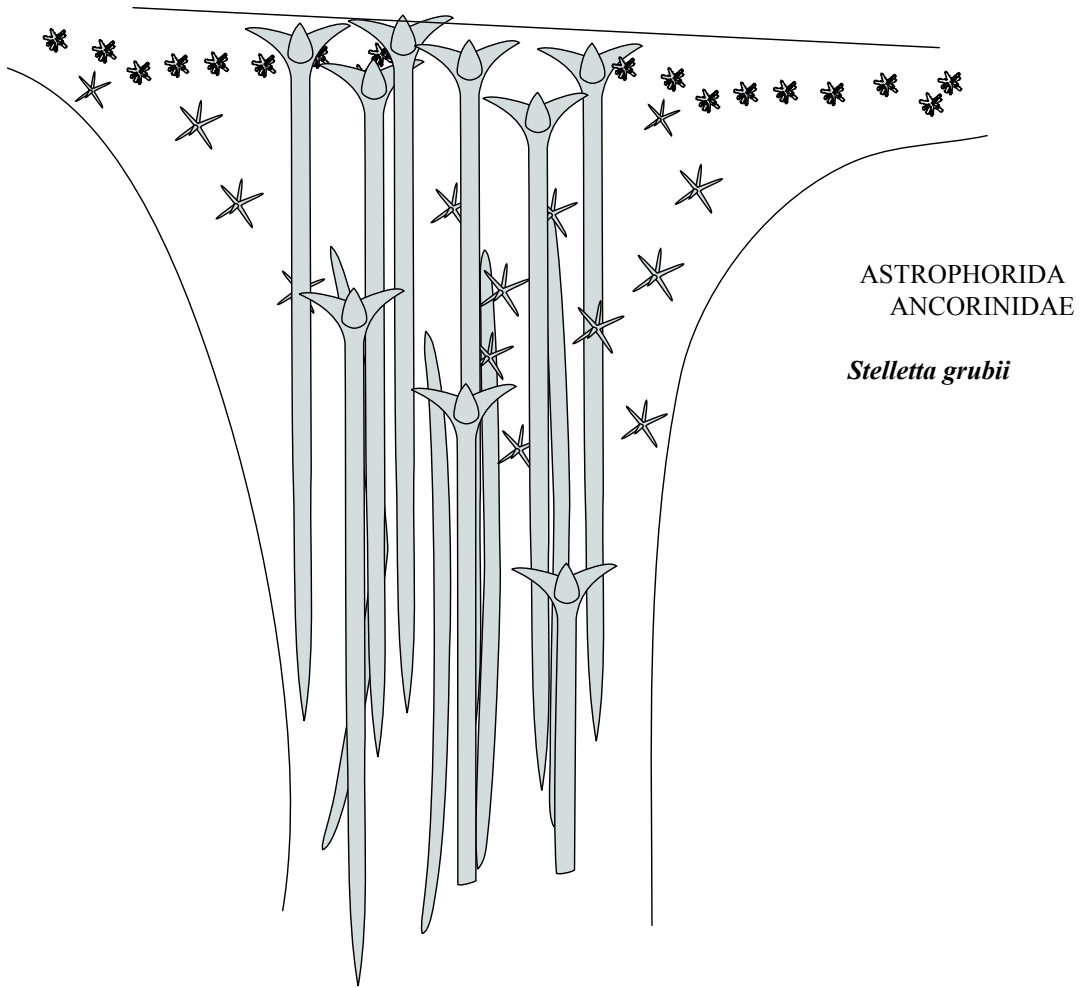

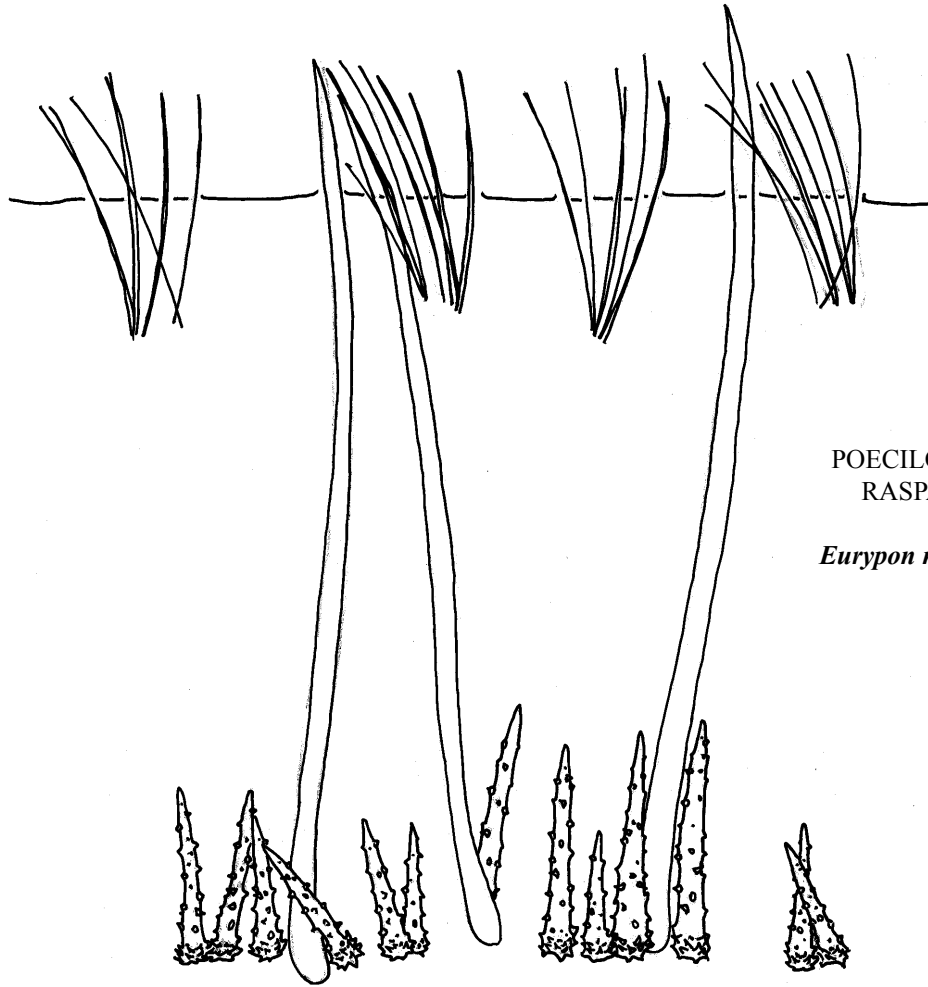

POECILOSCLERIDA  
RASPAILIIDAE

*Eurypon major*

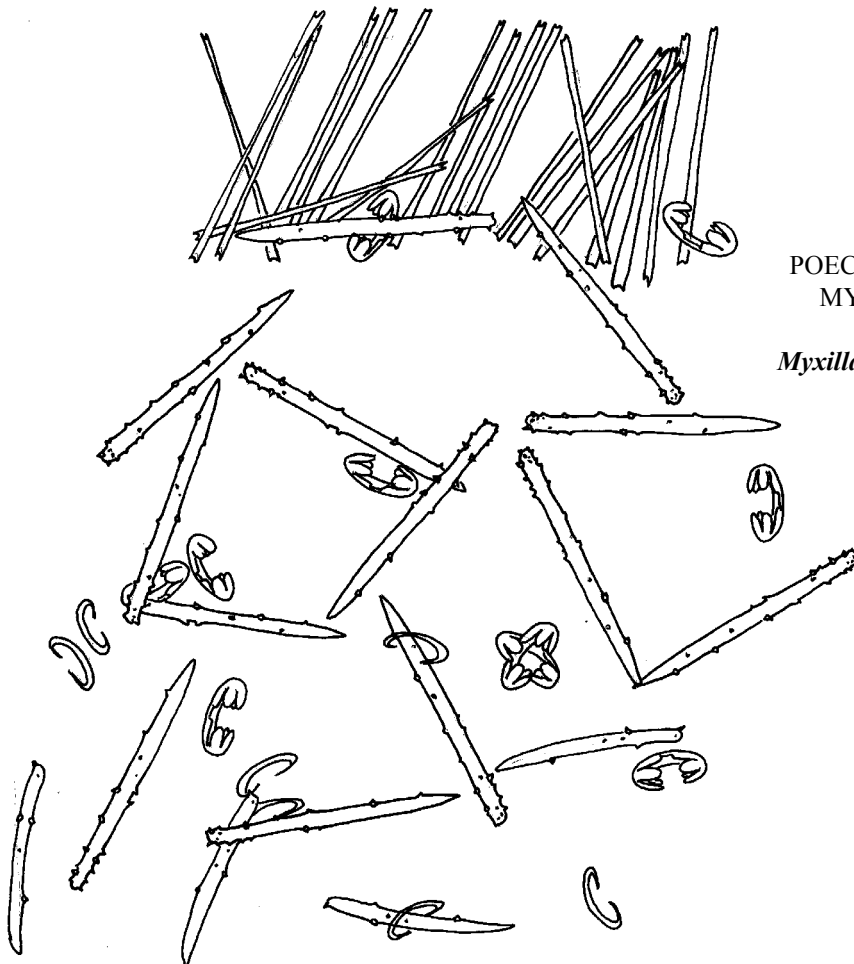

POECILOSCLERIDA  
MYXILLIDAE

*Myxilla rosacea*

POECILOSCLERIDA  
HYMEDESMIINAE

*Hymedesmia paupertas*

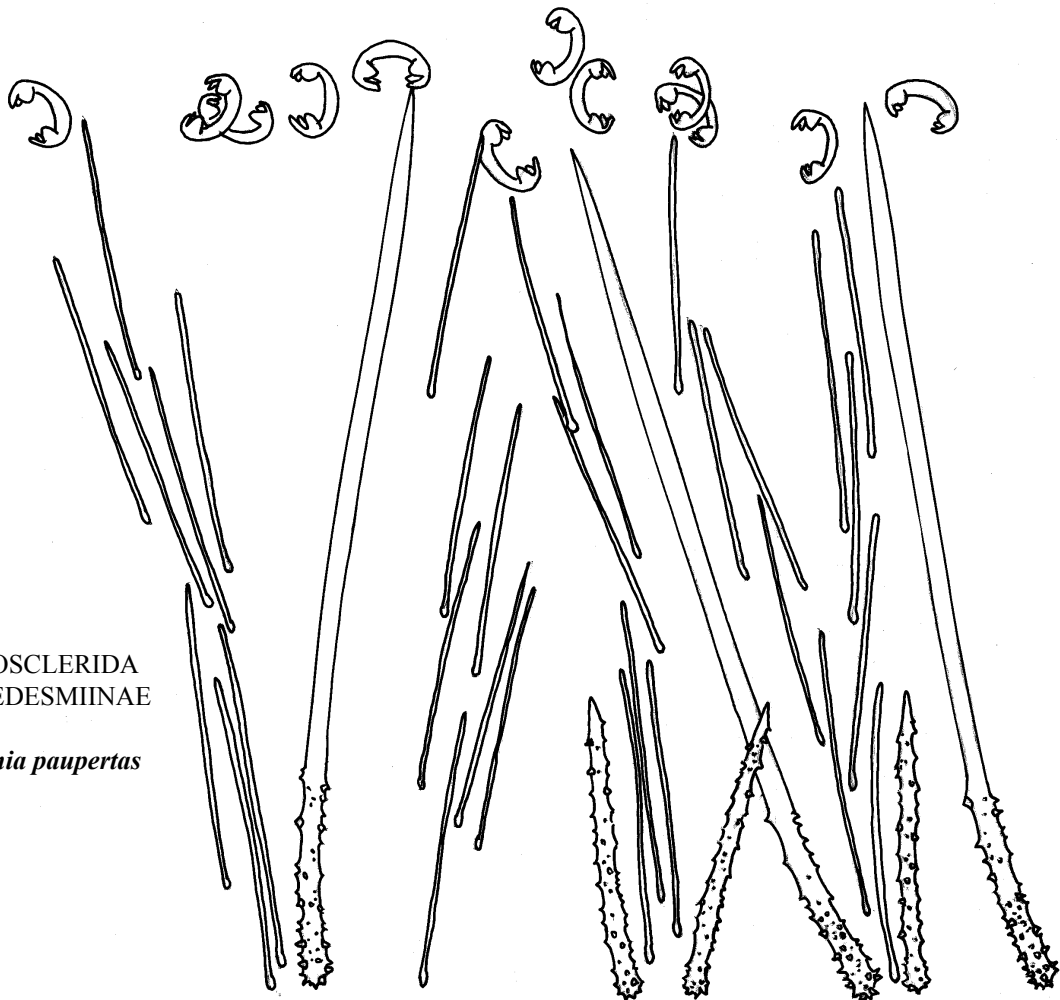

POECILOSCLERIDA  
PHORBASINAE

*Phorbas fictitius*

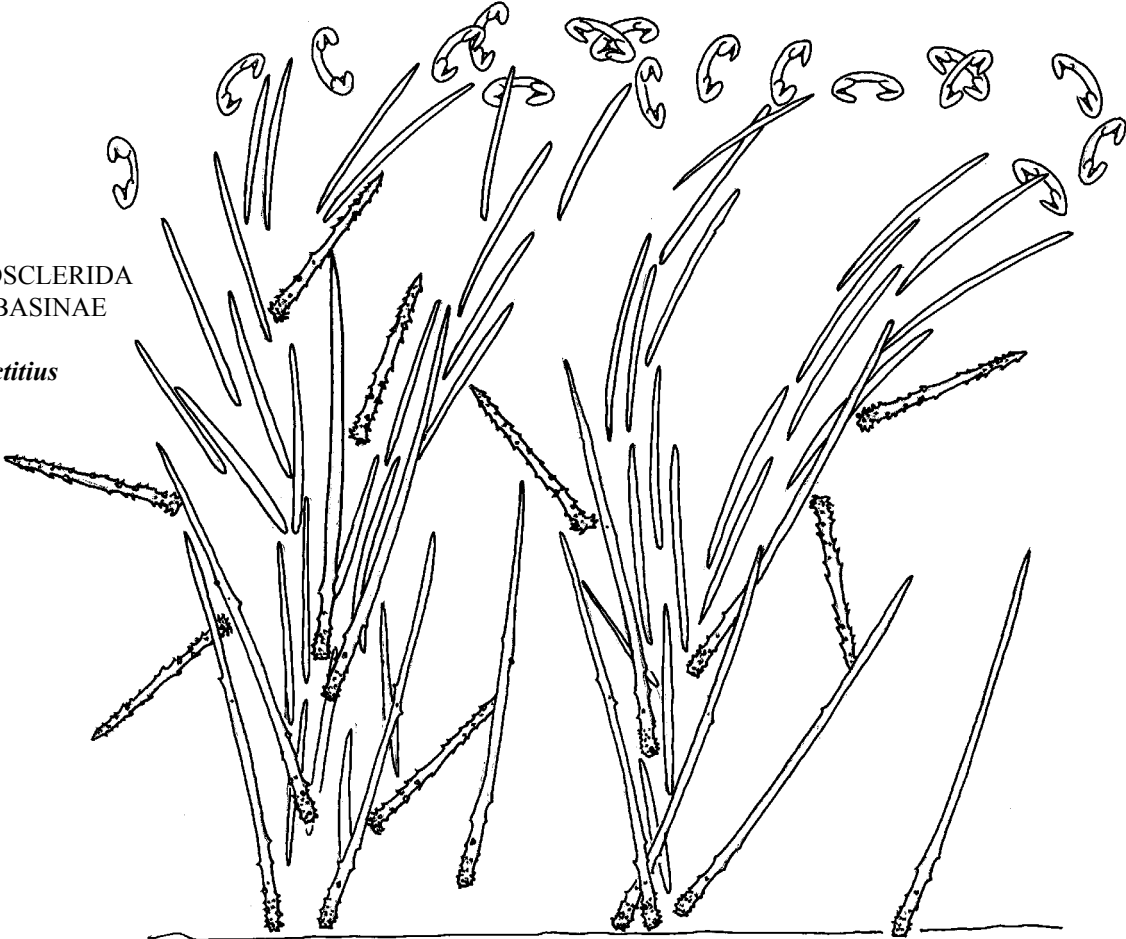

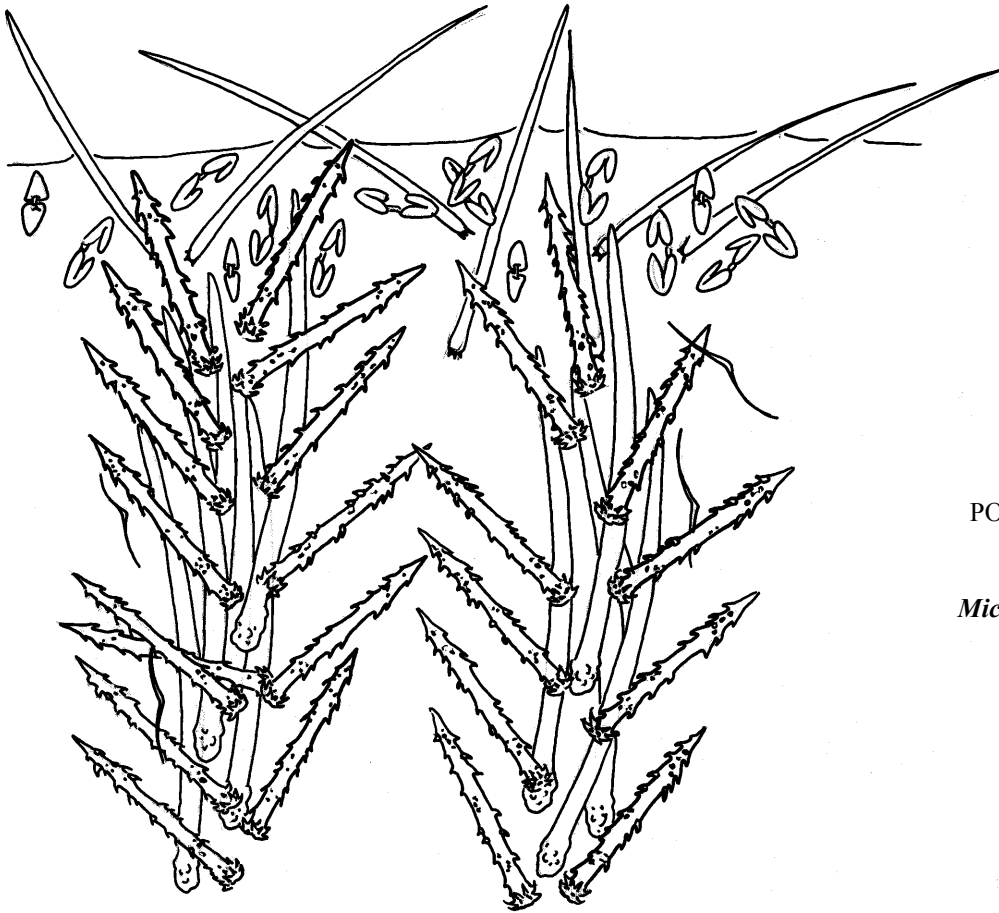

POECILOSCLERIDA  
MICROCIONIDAE

*Microciona armata*

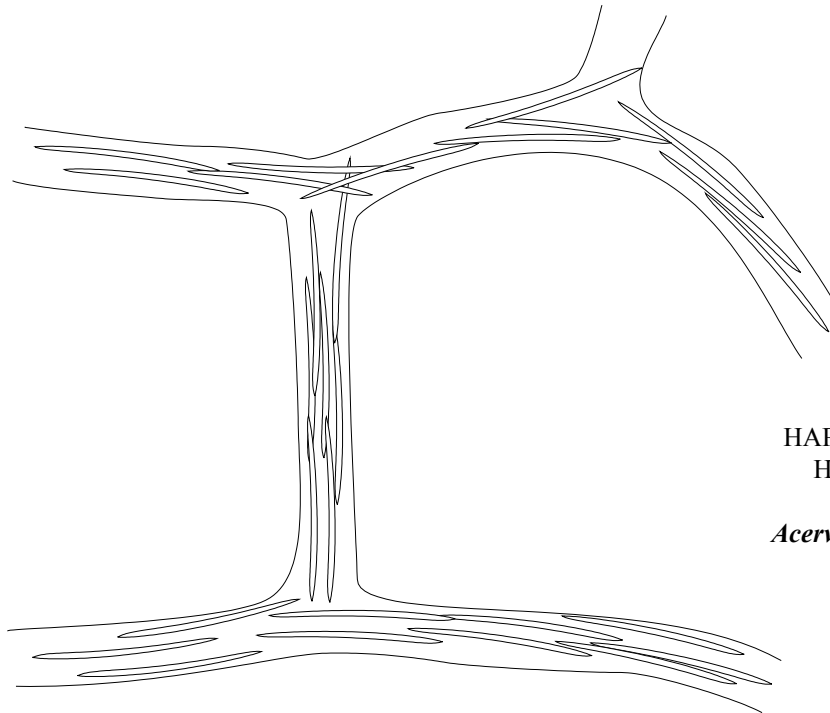

HAPLOSCLERIDA  
HALICLONIDAE

*Acervochalina limbata*

## TECHNIQUES

### 1. INTRODUCTION

Our knowledge of shallow water sponges of the British Isles is far from complete, and so users of this Guide are encouraged to assist in their study. The techniques involved include Observation, Collection, Photography, Recording, Preservation, Slide Preparations, and Identification, and these are described below.

### 2. OBSERVATION

Marine sponges are widely distributed in the seas of the world, from intertidal to hadal depths. In this Guide to British Isles sponges, we are concerned only with those species occurring in shallow waters - i.e. down to the continental shelf (200m), but in practice a limit of 50m is imposed by the restrictions of compressed air diving. There is little doubt that this Guide would not have evolved without the use of scuba-diving, which has enabled *in situ* observations of living sponges to be made.

Sublittorally, sponges are found mainly on hard rock substrates, but can occur on algae, or even loose on stable sediment bottoms. Massive or erect sponges are usually easy to spot, whereas encrusting sponges can be more cryptic owing to their small size and/or location. Some species tend to avoid the light and prefer to live in crevices or under overhangs. On the shore sponges occur in niches that remain wet or damp, and the undersides of large boulders are favoured habitats.

On a geographical level, the greatest sponge diversity occurs on the coasts of Ireland and south-west Britain. Diversity decreases northwards on the west coast of Scotland, and eastwards along the Channel. The least diverse region is the North Sea, but some boreal species are found only there.

On a local level, diversity and abundance can be variable and unpredictable. Different depth zones have different faunas, but all zones from the sublittoral fringe down to the lower circalittoral have their characteristic species, and are worth visiting. Highest diversity often occurs in areas of moderate tidal streams and some degree of shelter from wave action.

*In situ* observations are extremely valuable, and an underwater recording slate or shore note book should be used to collect as much information on the following topics as is practical - form, size, colour, surface, apertures, depth, microhabitats and abundance.

### 3. COLLECTION

The actual collection of specimens should not be undertaken lightly. Whilst the advances in our understanding reflected in this Guide could not have been made without collecting, the interests of conservation should be kept firmly in mind. Many species are slow growing and long lived, possibly 50 years old or more, and some are locally, or even nationally, rare.

#### The following strategy is recommended.

- 3.1. Prior to collection, record as much *in situ* information as possible (see previous section), and take one or more photographs (see next section).
- 3.2. Only collect if the specimen is to be fully "processed" in the ways outlined here. Collection cannot be justified unless it results in the maximum amount of information possible being gained, and the specimen being kept for posterity.
- 3.3. Only collect a few specimens per dive/shore trip. To fully process more than this tends to take an unacceptable length of time and may lead to confusion.
- 3.4. Only collect the **whole** specimen if this gives essential information about its form - otherwise only collect a representative part, to include basal and surface tissue. (The part left behind will continue to grow.)
- 3.5. With crusts, collect the substrate if possible. Sponges often overgrow barnacles or saddle-oysters and these are more easily removed than rock surfaces.
- 3.6. Spicule contamination can be avoided if each specimen is placed in a separate container as collected, numbered polythene bags are ideal when diving. A series of numbered zip top bags can be prepared beforehand and stored around the periphery of an underwater flashgun, held by a rubber band. They are then available in numerical order and can be matched up with the photographs taken.

### 4. PHOTOGRAPHY

Good quality underwater photography can give essential information concerning shape, colour and microhabitat of the living sponge *in situ*. If possible, take pictures of the whole sponge, to include habitat information, and close-ups to show surface characteristics. Additional valuable information can also be obtained by photographing collected specimens on land. This should include a 3 x 1cm tag with the accession number, and a penny piece, or ruler, for scale. If in adverse field conditions (e.g. on a hard boat), photograph the specimens out of water, against a black background. Otherwise use a black container

of seawater using flash or better still 2 flashes to minimise excessive shadow.

One of the flashes should be a key light and the other a fill in. The fill in should be placed at twice the distance of the key flash if both are of the same intensity.

If using film colour transparencies should always be used, and two of each shot taken to increase the likelihood of a good result and to allow one for loan if appropriate. Digital photography has now of course made it easy to check if the pictures are correctly lit and exposed.

A good photograph can enormously enhance the value of a collected specimen. Photography has been one of the major “tools” in the evolution of this Guide, and its value cannot be overstated. Those wishing to learn underwater photography should both acquire a suitable book (e.g. Rowlands, 1983), and join the British Society of Underwater Photographers, 4 Greyhound Road, London W6 8NX.

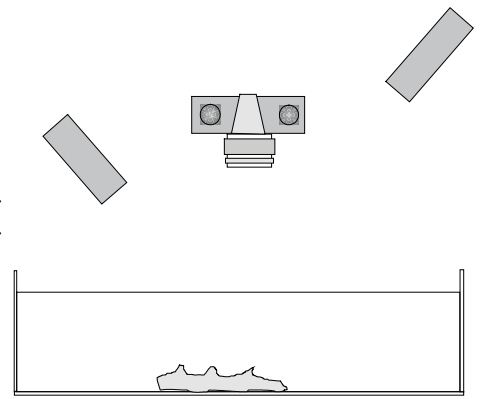

## 5. RECORDING

A significant contribution to this Guide has been the many records accumulated in the last few years. Although the process is time consuming, the completion of accurate, detailed and comprehensive records is essential for advancing our knowledge of British Isles sponges.

Records of four types are required, probably completed at different stages.

- 5.1. Site information. (see section 9 below on habitat recording).
- 5.2. Information from *in situ* observation - see section 2 above.
- 5.3. Details of the living specimen, immediately following collection. Make use of the terms in the glossary section of this guide.
- 5.4. Information from the specimen following preservation - see sections 7 and 8 below.

All the data that could be collected are described in detail in the Glossary and Reference Section. The terms therein should be used consistently and precisely, but one should be critical of the terminology, as this is still evolving. A recording form is available from G. Ackers.

## 6. PRESERVATION

Sponges should be preserved as soon as possible after collection and the completion of the appropriate records. They will only keep fresh for a few hours in cool seawater - if kept overnight, aeration should be used.

Preservation is easier than for many other organisms, involving simply immersion in ethanol or isopropanol (iso-propyl alcohol) are the preferred preservatives as they are much less damaging to DNA than the traditional industrial meths. Isopropanol (iso-propyl alcohol) is obtainable from a high street chemist, but ethanol is very restricted in its availability in most countries. Strength is not critical, as a 95% solution will become diluted with the water from the specimen. However, a large specimen may cause too much dilution, in which case the alcohol should be changed between 1 and 5 days later. Samples for DNA extraction should be cut into small pieces and the alcohol should be changed after a few hours, so as to dehydrate the specimen as completely as possible.

Before alcohol can be purchased, a Customs and Excise license is required, and this is not usually granted to private citizens. Biological institutions normally have a license, as does the Marine Conservation Society, 4 Gloucester Road, Ross-on-Wye, Herefordshire HR9 5BU.

Alternatives to the above are industrial methylated spirit (IMS - colloquially “alcohol” or “spirit”) and the ordinary methylated spirit from a hardware store. However, the former degrades DNA, and the latter is unpleasant to use, and also causes over-hardening of the specimen.

Traditionally, sponges were preserved dry. If done properly, the overall shape of the specimen will be retained, but the subsequent preparation and examination of sections for the microscope is unsatisfactory. The specimen should be dried in a gentle current of air. Seaweed biologists have been very successful extracting DNA from specimens dried and preserved in powdered silica gel and this may be a useful technique for sponges.

In the field, sponges can be preserved with alcohol in polythene bags, either the zip-top sort or sealed with a rubber band.

Labels about 3 x 1cm, should be cut from a high quality writing paper, or goat-skin parchment and put into the bag immediately. Either a soft (2B) pencil, or a waterproof indian ink can be used for writing. The polythene bags can be kept in a large plastic bucket of spirit for the duration of the trip, following which the sponges can be transferred to individual jars, with fresh spirit if appropriate.

## 7. SLIDE PREPARATION

### 7.1. Introduction

Microscope slide preparations are required for the examination of skeletons and spicules. By far the most useful preparation from a taxonomic point of view is a section. The arrangement of the spicules and other tissues forming the skeleton gives vital information for the identification of a sponge. Rarely will a preparation of spicules alone suffice, although it can provide useful additional information where spicules are difficult to differentiate in a section.

The two types of slide preparation are described below. Note that clove oil is obtainable from high street chemist shops, and Euparal from GBI Laboratories Ltd., Shepley Industrial Estate, Audenshaw, Manchester M34 5DW.

### 7.2. Section preparation

- a. Leave the sponge in spirit for at least 24 hours (preferably longer) to harden and desiccate.
- b. Cut thin slices from the sponge; not too thin, or very few whole spicules will be included, but thin enough to allow the cover slip to sit flat on the slide. The problem with broken spicules is why hand sections are usually preferable to microtome sections. Include slices from the surface, at right angles to the surface to include surface and deeper tissue, and if the sponge has an axial structure, a longitudinal slice from the middle. Many encrusting species and some massive species (e.g. *Tethyspira spinosa*) have special spicule categories in the basal layer where the sponge adjoins the substratum, so ensure that this region is included. Most species have special layers at the surface so always include this in the section.
- c. To cut sections, use a sharp scalpel, a 'cut throat' razor, a safety razor blade, or an ordinary razor blade. For firm sponges a sawing action is best and for soft ones a single, decisive stroke. Sharpen the 'cut throat' razor on a smooth oil stone frequently. Spicules are harder than steel!
- d. Immerse the sections in absolute alcohol in a small watch-glass until they are free of water. (15 mins). If the specimens are recently collected two changes of absolute alcohol may be necessary to remove all water from the tissue.
- e. Transfer the sections to clove oil in another watch-glass and leave until the sections look translucent. A milky look indicates that water remains in the sections - go back to alcohol again. Clove oil goes milky if the mounting is performed in a damp atmosphere, so don't breath on it! (An alternative clearing agent is xylene (xylol), which does not inhibit the setting of Canada balsam so much. However, clove oil is more easily obtainable, and has some desiccating properties of its own).
- f. Transfer the sections to a slide, and mount in a drop of Canada balsam or Euparal (which has slight desiccating properties). Carefully lower a cover slip onto the section, round ones are less prone to trap bubbles. Gently squash the cover slip down with the blunt end of a pencil. Label the slide immediately with the code number of the specimen to avoid possible confusion. Ensure the slide label identifies the orientation of the sections if you are unfamiliar with sponge sections.
- g. The slide may be examined immediately under objectives up to 40X magnification but beware of disturbing the cover slip. Leave to dry for several months; the presence of clove oil increases the drying time of Canada balsam dramatically. A slightly raised temperature, such as in an airing cupboard, accelerates the process.

### 7.3. Spicule preparation

7.3.1. For sponges with siliceous spicules (i.e. Demospongiae).

**WARNING. This method involves the use of highly dangerous concentrated nitric acid, and should only be undertaken in laboratory conditions conforming to the appropriate Health & Safety standards.**

- a. Select areas of sponge which are likely to have variation of spicules: i.e. base, skin, walls of internal cavity, oscular region etc.
- b. Remove a small piece (0.5 cm<sup>3</sup>) from a selected area and place it in a boiling tube.
- c. Gently add enough concentrated. nitric acid to cover the fragment and then if necessary, either warm over a spirit burner or Bunsen or heat in a water bath until all the tissue has dissolved.

- d. When no tissue remains carefully add distilled water and agitate. Allow the tube to stand for up to 2 hours to ensure that light-weight spicules have settled to the bottom before pipetting or draining off the surplus liquid. Repeat the washing process 3 or 4 times until all the nitric acid has been removed, then wash with absolute alcohol.
- f. Finally pipette off as much alcohol as possible without losing the spicules and add 1-2cc of absolute alcohol.
- g. After shaking the tube spread the suspension of spicules in alcohol on to slides by means of a pipette and speed evaporation of the alcohol by passing the slides over a flame. (Careful, the alcohol will usually burn off!)
- h. Mount in Araldite, Canada balsam or Euparal. On a well prepared slide the spicules should be clean and numerous but well separated.
- i. Potassium hydroxide (caustic potash) or sodium hydroxide (caustic soda) is an alternative to nitric acid. **N.B. These are also dangerous substances.**

### 7.3.2. For sponges with calcareous spicules (i.e. Calcarea).

These sponges have calcareous spicules (they dissolve in acid). Caveat: adding acid to the whole sponge and observing fizzing is not conclusive evidence for the presence of calcareous spicules, because non calcareous sponges often incorporate pieces of shell in their bodies.

The method is basically the same as that for siliceous spicules but bleach or caustic potash must be used to dissolve the tissue. The spicules are very soluble in acids, even acid in the preservative (beware formalin) may have dissolved the spicules! Dissolution of the tissue is not so rapid using this method.

## 8. IDENTIFICATION

### 8.1. Introduction

Like any learning process, naming sponges is likely to involve some mistakes on the part of those who are developing an interest in the group. Sponge identification is difficult; the highly variable nature of the growth patterns and the subtle distinctions between certain species dictate that utmost care must be exercised when arriving at the name of a sponge. This is especially so if the name is to be used in a survey report or a published work. Before embarking on an identification, the following “inputs” are required - the specimen, slide preparation(s), photograph(s), recorded information, a microscope, and literature.

### 8.2. Microscopy

For the examination of the slide preparation, a compound microscope is required. The more modern (and expensive!) models found in institutions tend to be relatively easy to use, having an integral light source, and binocular eyepieces. A range of magnifications from 40x to 400x is ideal. Those with access to the older style traditional compound microscopes could consult White, 1978 for guidance on use. This is available in booklet form, as a reprint, from The Quekett Microscopical Club, c/o British Museum (Natural History), Cromwell Road, London SW7 5BD. Also, there are many general books on microscopy (e.g. Hartley, 1979) that provide useful introductions to the subject.

### 8.3. Literature

Unfortunately, the literature of potential relevance to the identification of British sponges is voluminous, widespread, and often difficult to obtain. Two starting points are the bibliographies of Vosmaer (1928) and the Porifera and Archaeocyatha section of The Zoological Record. The latter is now published by BIOSIS, 2100 Arch Street, Philadelphia, Pennsylvania 19103, USA. *Systema Porifera* (Hooper, J.N.A. & Van Soest, R. W.M. (eds) 2002. *Systema Porifera*. A guide to the classification of sponges. I-xix, 1-1708, i-xlvi. Kluwer Academic Publishers, New York.) is an invaluable guide to sponge classification to genus level. Another useful reference is *Sponges of the North East Atlantic* (World Biodiversity Database CD-ROM Series) Authors: R.W.M. van Soest, B. Picton & C. Morrow. Publisher ETI. This taxonomic reference work was made by Rob van Soest, Zoological Museum, University of Amsterdam and Bernard Picton and Christine Morrow, Ulster Museum, Belfast. It is a unique, comprehensive guide to shallow-water sponges occurring in the coastal waters of Western Europe between the Arctic and southern Portugal. The CD-ROM contains up-to-date information on 337 shallow-water sponges, including a fully illustrated multiple-entry key, text key and interactive distribution maps. All text is hyperlinked.

The principal authors producing work relevant to British sponges are (or were!): W. Arndt, J.S. Bowerbank, M. Burton, L. Cabioch, C. Lévi, E.O. Schmidt, J. Stephens and E. Topsent. The two main monographic works are Arndt (1935) and Bowerbank (1864-1882). However, neither are particularly easy to use, and both are taxonomically out of date, and misleading in places. Arndt is written in German, concentrating on spicule characters, and having no illustrations of skeletons or specimens. Bowerbank uses an obsolete form of language for spicules, and of necessity concentrates his description on



preserved rather than living material.

Those works that concentrate on specific taxonomic groups (e.g. Lévi, 1960; Topsent, 1900 and 1924), or sponges from a particular area (e.g. Burton, 1930; Cabioch, 1968) tend to be more helpful. Some references to these, as well as to papers dealing with individual genera or species, will be found on the species sheets. There is a bibliography of useful references at the end of this publication.

Marine faunas can provide good starting points, acting as check lists for sponges present in an area, as well as providing literature references. Three such are the Plymouth Marine Fauna (1957), the Roscoff Marine Fauna (Borojevic, Cabioch and Lévi, 1968, and the Lundy Marine Fauna (Hiscock, Stone & George, 1983[1984]). The latter includes non-technical descriptions of external form.

Literature can of course be consulted in the major reference libraries including the British Museum (Natural History), which runs a photocopying service (at a price!) Although it is not always apparent, some works are still in print. These, and second hand out of print works, can sometimes be obtained from specialist natural history booksellers such as Wheldon & Wesley Ltd., Lytton Lodge, Codicote, Hitchin, Herts, SG4 8TE.

The internet is becoming an invaluable source of new information on sponges. This guide is hosted at [http://www.habitas.org.uk/marinelife/sponge\\_guide/](http://www.habitas.org.uk/marinelife/sponge_guide/) with additional species accounts and there is a world list of extant sponges at <http://www.vliz.be/vmdcdata/porifera/>. The latest developments in DNA barcoding of sponges can be found at <http://www.spongebarcoding.org/>.

#### 8.4. Methods

Traditional methods of identification have centred on the skeleton and spicules, and descriptions of these are included in this Guide. The types, sizes, abundance, organisation and orientation of spicules on the surface, in the body, and at the base of the sponge are important. However, it is also important to use the living features and photographs, and to test their value when making an identification.

As a lead into the species sheets, the Table of Species Characteristics (next section) has been prepared, and should be consulted for clues by inexperienced users wishing to attempt an identification. Previous versions of this Guide have stated quite clearly that no reliance should be placed on any identification without microscopic examination. Whilst this still holds true, certain sponges can often be identified provisionally by sight alone, and these are indicated in the Table. Several other species can be recognised as being one of a pair. This phenomenon is rather curious, because the two species are not necessarily as close to each other taxonomically as they are to different species. The 'pairs' to watch out for are as follows:

*Leucosolenia complicata* - *L. variabilis*; *Leuconia gossei* - *L. nivea*; *Suberites carnosus* - *S. domuncula*; *Polymastia boletiformis* - *P. mamillaris*; *Axinella damicornis* - *Stelligera rigida*; *Axinella infundibuliformis* - *Phakellia ventilabrum*; *Stelligera stuposa* - *Raspailia hispida*; *Halichondria bowerbanki* - *H. panicea* (sublittoral form); *Hemimycale columella* - *Phorbas fictitius*.

It must be remembered that whilst all the commoner shallow water sponges are included in this Guide, it is by no means comprehensive. In many cases, particularly encrusting species, further literature will need to be consulted for an identification. If all else fails, the authors may be prepared to attempt identifications of limited amounts of material collected and curated to the standards outlined above.

### 9. HABITAT

The Marine Conservation Society, in association with the Nature Conservancy Council, has produced a comprehensive Sublittoral Habitat Record form. As noted below, many of the categories on this form are relevant when recording information about a single specimen. Indeed, data on the first three sections below need not be duplicated if a completed MCS form is available. However, information in the last two sections relates specifically to the sponge, and should be recorded. Each type of habitat data is categorized as Compulsory, Important, or Optional -hopefully self-explanatory terms.

Finally, one should not be constrained by the guidelines below. Information that cannot be predicted and/or categorized may be very important, and should be noted.

#### 9.1. Site information

**Site name** (Important). Preferably use a name that appears on an Admiralty Chart, or 1:50,000 Ordnance Survey (O.S.) map.

For an offshore sublittoral site, a colloquial local name used by divers and/or fishermen may have to suffice.

**Site number** (Optional). In surveys such as those run by MCS, a site number is usually allocated.

**Survey area** (Important). The general area - this **must** appear on either an Admiralty Chart or O.S. map.

**O.S. grid reference, and/or latitude/longitude** (Compulsory). Indicate source and datum - eg. GPS WGS84.

**Date** (Compulsory). Use an unequivocal format, e.g. 12 MAY 1990.

**Name of recorder/collector** (Compulsory).

**Duration of search** (Optional).

**Address/phone number** (Optional).

**Depth (in metres)** (Compulsory). Either correct to chart datum, or indicate time of search.

## 9.2. Surface conditions

**All definitions in this section are taken from the MCS form.**

### Wave exposure (Important).

Very Exposed. Prevailing wind and swell.

Exposed. Prevailing wind.

Semi-Exposed. Strong wind frequent.

Sheltered. Strong wind rare.

Very Sheltered. Fetch 20km.

Extremely Sheltered. Fetch 3km.

### Tidal stream strength (Important).

Very Strong. 6 knots +.

Strong. 3-6 knots.

Moderately Strong. 1-3 knots.

Weak. 1 knot.

Very Weak. Negligible.

**Salinity (Optional)**. Would be very useful, however, if the salinity was known, or suspected, to be low.

Normal. Around 34‰.

Variable. 30‰+.

Low. 30‰..

**Coastal type (Optional)**. The complete list on the MCS form is Headland, 'Linear Coast', Bay, Spit/Bar, Offshore Small Island, Amongst Rocks/Islets, Sound/Narrows, Shallow Rapids, Sea Loch, Estuary, Coastal Lagoon, Harbour, Sea Cave, Other. In this context, those categories in the second part of the list could be significant.

## 9.3 Underwater conditions

### Depth zone (Important)

"**The Sublittoral Fringe** is the transition zone between the littoral and sub-littoral zones and, on the open coast, lies above the main *Laminaria hyperborea* population" Below this, the divisions are:

"An **Upper Infralittoral** where a forest of Laminariales is present";

"A **Lower Infralittoral** where Laminariales are absent or sparse but dense algae dominate the rock";

"An **Upper Circalittoral** where animals predominate but scattered erect algae are present";

"A **Lower Circalittoral** where erect algae are absent".

Note also that "it is most convenient to consider the term infralittoral to apply to any levels that are dominated by subtidal erect algae, as kelp plants are sometimes absent." (All definitions from Hiscock and Mitchell, 1980).

**Substrate** (Optional). Interesting or unusual substrates present could be worth recording, but a detailed description is more appropriate to a habitat survey than a record for an individual sponge. The MCS form contains the following list from which to take descriptions: Bedrock, Large Boulders (0.8m+), Small Boulders (0.5m), Large Cobbles (128-256mm), Large Slates (128-256mm), Small Angular Cobbles (64-128mm), Small Round Cobbles (64-128mm), Small Slates (64-128mm), Very Large and Large Angular Pebbles (16-64mm), Very Large and Large Round Pebbles (16-64mm), Medium and Small Pebbles (4-16mm), Clean Gravel (2-4mm), Muddy Gravel (2-4mm), Maerl, Clean Shell Gravel, Muddy Shell Gravel, Coarse Sand (0.5-2mm), Fine Clean Sand, Fine Muddy Sand, Sandy Mud, Mud, Clay, Metal, Concrete, Wood, Other.

**Site features** (Optional). Any topographical features that could be of interest.

**Communities present** (Optional). Could be of interest, particularly if the sponge is seen as part of a community (e.g. see Könnecker, 1973).

**Other sponges (Important)**. It is relevant in this context to record other sponges present in the immediate area, and a note of their abundance (see below).

## 9.4 Microhabitat information

Any distinctive features of the immediate microhabitat of the sponge should be recorded in particular:

**Substratum (Important).** Record the substrate to which the sponge was attached. Use the categories from the previous section, plus living substrate - algae, and other animals (including sponges). Record where the sponge occurred on a living substrate.

**Silt (Important).** Record whether or not the substratum in the vicinity of the sponge was silty.

**Inclination and orientation (Important).** Record the inclination of the substrate to which the sponge was attached, and the sponge's orientation. Use the categories: Overhang, Vertical (80-100°), Very Steep (40-80°), Steep (20-40°), Shallow (<20°), Horizontal. Also record whether the specimen was found in a cave, gully, or under a boulder/cobble. Indicate if flush with the surface, above it, below it, or embedded in sediment.

**Light (Important).** This is obviously affected by inclination and depth (bearing in mind weather conditions and time of day of observation). It is important to record explicitly whether the sponge is shaded and, if so, by what?

**Competition (Optional).** Record any competition for space by, or on, the sponge. e.g. was a bryozoan/hydroid "turf" apparently smothering the sponge, or was the sponge overgrowing other sessile organisms?

## 9.5 Information on the sponge itself

**Abundance (Important).** The abundance of the species should be recorded, using the following definitions:

Rare : 1-4 specimens per site in 30 minutes.

Occasional : 5-24 specimens per site in 30 minutes.

Frequent : 25-49 specimens per site in 30 minutes.

Common : 50-99 specimens per site in 30 minutes.

Abundant : More than 100 specimens per site in 30 minutes.

These definitions, adapted from Hiscock, 1979, can be difficult to apply precisely. However, subjective judgement, acquired with practise, can be almost as valuable. The definitions apply to massive sponges and so different criteria may need to be used for erect branching forms, crusts and purse sponges.

**Silt (Important).** Whether the surface is clean, covered with silt (or epibiotic material) should be noted.

**Associations (Important).** Record any other organisms that are feeding on, or living on, or in the sponge.

**Photographs (Important).** Record whether there are any photographs of the sponge.

**Accession number (Important).** It is useful to have a numbering system to identify uniquely the specimen in your collection. Prefix it, e.g. with your initials, to avoid confusion with the specimens of others, should you send your specimen to someone else. This helps keep slides, photographs and specimens linked together.

**Provisional name (Important).** Note any name given, plus (later) references used to determine the name.

Principal sites cited in text



***Clathrina coriacea* (Montagu, 1818:116)**

Family CLATHRINIDAE

Synonyms *Leucosolenia coriacea* (Montagu, 1818:116) Bowerbank, 1866:34. This species was regarded by Burton (1963:183) to be one of several 'Named Forms' comprising *Clathrina coriacea* (Montagu, 1818), the name he accepted as valid for the whole complex. Most authors now consider other entities in this complex to be valid species. These include *Clathrina contorta*, *Clathrina cerebrum* and *Clathrina clathrus*, all of which may occur in the British Isles. The description given here may apply to an aggregate of several species.

Form Consists of three dimensional network of anastomosing thin walled tubes, which form a compact, low-lying anastomosing mass attached directly to the substrate. There are no erect free branches.

Photographs 1. Duncan's Bo, Rathlin. with *Dendrodoa*. (B. E. Picton)  
2. Connor rocks, N. Blasket sound. Mc1959. Sheet form. (B. E. Picton)

Colour Usually white, but can be grey, pale rose, orange or sulphur yellow.

Smell None.

Consistency Soft, delicate.

Surface Of tubes, smooth and soft.

Apertures Several tubes join to share one common oscule, slightly raised above the surface, "but never marked tubular".

Contraction Not noticeable (?).

Spicules Spicules are triradiates only (60-120µm long x 6-12µm wide) (cf. *L. botryoides* which usually has oxea and quadriradiates in addition), with rays which meet at equal angles.

Voucher BELUM : Mc5. Strangford Lough, Down.

Habitat Found on clean rock surfaces, also under overhangs and boulders on the shore. Primarily a shallow water species. Often found associated with *Dendrodoa*, in surge gullies etc. but also found in sheltered situations (caves, overhangs). Further research may reveal this to be a complex of species.

Distribution In the east Atlantic it is found from "the Arctic to S. Africa". "Littoral to 650m." A common species in the British Isles on all coasts.

Identity Once the sponge is well known, it can usually be identified by sight, but beware *L. botryoides* (q.v.) which also consists of thin-walled tubes. If the specimen is intermediate between the two species, a microscopic section needs to be examined to ensure only triradiates are present. Some bryozoa have a superficially similar form but are hard. One species of colonial tunicate at a superficial glance looks a little like *C. coriacea* but on closer inspection can be seen not to consist of tubes.

References Arndt, 1935, p.7.  
Bowerbank, 1874, p.8.  
Burton, 1963, p.190.  
Dendy and Row, 1913, p.725.  
Topsent, 1936a, p.2.

Sources J.D. Guiterman, R. Earll, B. E. Picton

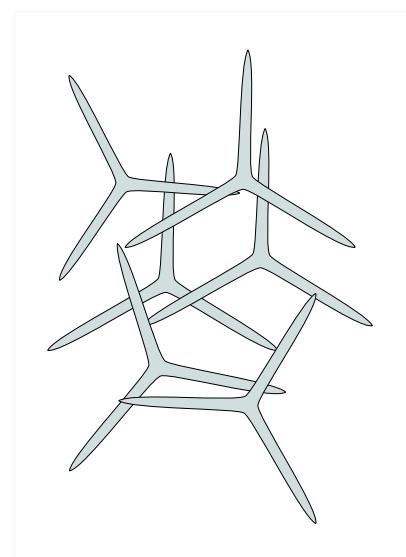

Editors J.D. Guiterman, D. Moss, B.E. Picton.

***Guancha lacunosa* (Bean in Johnston, 1842: 176)**

Family	CLATHRINIDAE
Synonyms	<i>Leucosolenia lacunosa</i> (Bean in Johnston, 1842). This species was regarded by Burton (1963: 183) as being one of several “Named Forms” comprising <i>Clathrina coriacea</i> (Montagu, 1818) which he accepted as the valid name for the whole complex.
Form	Stipitate, the stalk bearing a roughly ovoid, sometimes slightly flattened, body, consisting of a network of thin walled anastomosing tubes. Maximum height 3cms, although specimens are frequently less than half this size.
Photograph	
Colour	White, off white.
Smell	None.
Slime	None.
Consistency	“Firm to soft”; even tough and resilient.
Surface	In macro view, the sponge surface is even. The surfaces of the individual tubes are smooth.
Apertures	A single oscule (?sometimes more) borne at the apex of the sponge.
Contraction	Not noticeable.
Skeleton	The skeleton consists of triradiates distributed throughout the body, with diactinal spicules occurring at the base of the body, and in the stalk.
Spicules	The triradiates are of two types: (a) with rays of equal length, 80-300µm; (b) sagittal triradiates with the basal ray (90-600µm) longer than the two paired rays (60-300µm). The latter paired rays may exhibit abnormalities. The diactinal spicules (oxea) (c) are 80-300µm long. The growth point is normally marked by a central irregularity.
Voucher	
Habitat	On vertical, hard surfaces. Often found attached to empty shells in sheltered conditions in sea lochs. Also reported growing on hydroids and bryozoans. “Littoral to 220m”. (Note. This small, inconspicuous and delicate species can be quite difficult to spot. More habitat information is required).
Distribution	Around the Atlantic coasts of Europe it is known from Plymouth, Brittany, Ramsgate, Scarborough, Berwick, St. Andrews, and Shetland. Known recently from Salcombe (Devon), Sound of Jura (Hebrides) and Strangford Lough. Also from the Arctic and Mediterranean.
Identity	The external form (“like a <i>Clathrina coriacea</i> on a stalk”) is characteristic.
References	Arndt, 1935, p.8 Bowerbank, 1866, p.32; 1874, p.9 Burton, 1963, p.197 Topsent, 1936a, p.14.
Source	G. Ackers (B. Picton). <span style="float: right;">Editor D. Moss.</span>
	Draft 1 2/90



***Leucosolenia complicata* (Montagu, 1818:97)**

Family	LEUCOSOLENIDAE
Synonyms	None in common use. Treated by Burton (1963:159) as one of several 'Named Forms' comprising <i>Leucosolenia botryoides</i> (Ellis and Solander, 1786:190), the name which he regarded as valid for the whole complex.
Form	The sponge consists of a basal reticulation of thin-walled tubes which creep and anastomose over the substrate, from which arise numerous, long, free-standing, closely-set oscular tubes which are always provided with lateral diverticula, which may subdivide even further. "It occurs as a bushy form and as an arborescent form."
Photographs	Port Isaac, N. Cornwall. (B.E. Picton)
Colour	Off-white to grey.
Smell	None.
Consistency	Very delicate and soft; "very fragile".
Surface	That of the tubes is soft and smooth; "minutely hispid".
Apertures	The oscules are terminal on erect tubes. "The oscular rim is short."
Contraction	The tubes cling together by surface tension when out of the water. Otherwise no noticeable contraction occurs.
Skeleton	The skeleton of the chamber layer consists of triradiates. The endosomal skeleton is of quadriradiates, which also line the atrial cavity. Oxea are also present.
Spicules	Triradiates have paired rays 75-90 x ca. 7µm thick and basal ray 100-200µm long x ca. 6µm thick. Quadriradiates have basal ray 100-200µm long x ca. 6µm thick, the other rays are 70-90 x ca. 7µm. The oxea are of two sizes; the larger, 190-280 x 9-10µm thick, usually have lanceolate distal ends and curved shafts; the smaller are usually abundant, without lanceolate endings, 70-140 x ca. 3µm thick.
Voucher	BELUM : Mc
Habitat	This sponge reaches its optimal development under overhangs on the shore, growing as compact, hanging 'bunches', often associated with the red alga, <i>Phumaria elegans</i> . "Rarely found in situations in which it is liable to be left dry at low tide." The 'bushy form' may be more typical of muddy estuarine conditions; the 'arborescent form' of clean water, free of mud and sediment? Observations would be welcome on this feature.
Distribution	"Arctic; Atlantic coasts of Europe; Mediterranean, etc." "Littoral to 93m."
Identity	Superficially this species can be confused with several other 'Named Forms' of <i>Leucosolenia</i> , including <i>L. botryoides</i> , <i>L. variabilis</i> and <i>L. contorta</i> . Can field characters be established to separate them?
References	Arndt, 1935, p.5. Burton, 1963, p.159. Dendy and Row, 1913, p.721. Minchin, 1904[1905], p.360. Topsent, 1936a, p.27.
Source	S.M. Stone.
Editors	D. Moss, B.E. Picton.

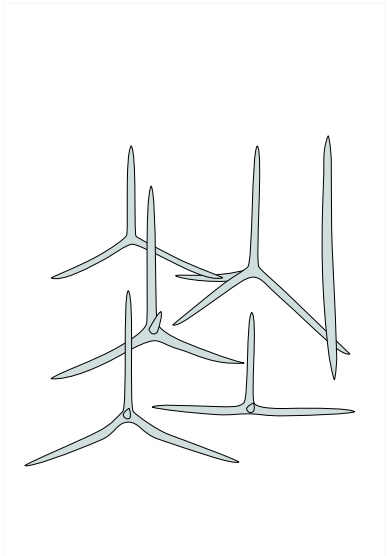

***Leucosolenia variabilis* Haeckel, 1870:243.**

Family	LEUCOSOLENIDAE	
Synonyms	None in common use. Treated by Burton (1963:173) as being one of several 'Named Forms' comprising <i>Leucosolenia botryoides</i> (Ellis and Solander, 1786:190), the name which he regarded as valid for the whole complex.	
Form	This sponge consists of a basal reticulation of thin-walled tubes which creep and anastomose over the substrate, from which arise numerous very (up to 2cm) long, free-standing, closely-set, oscular tubes showing "little or no tendency to throw out lateral diverticula except near their base". "It occurs as a spreading form and as a straggly bushy form" (never as an arborescent form (?)).	
Photographs	North Water, Mulroy Bay. (B.E. Picton)	
Colour	"White, yellow or grey when alive."	
Smell	None.	
Consistency	Very delicate and soft, but perhaps not as fragile as <i>L. complicata</i> which easily breaks when handled (?).	
Surface	That of the tubes is soft and smooth; "minutely hispid".	
Apertures	Oscules are terminal on erect tubes. "The oscular rims are long" [longer than in <i>L. complicata</i> ]. "Oscular tubes show no tendency to anastomose." (?)	
Contraction	The tubes cling together by surface tension when out of the water. Otherwise no noticeable contraction takes place.	
Skeleton	The skeleton of the chamber layer is of triradiates. The endosomal skeleton is of quadriradiates, which also line the atrial cavity. Oxea are present.	
Spicules	Triradiates (a) have rays 80-100µm long x 7-8µm thick; the basal ray generally is shorter, 65-83µm long x 6-7µm thick. Peculiarly modified triradiates termed "brackets" by Minchin regularly occur which have the short basal ray curved out of the facial plane in which the paired rays lie (same sizes). Quadriradiates (b) with rays of similar size to the triradiates and with apical ray ca. 80µm long. Oxea (c) are of 2 sizes; the larger have lanceolate distal ends with more or less straight shafts, 80-320 x 2-9µm thick; the smaller are less abundant with distinct lanceolate endings, 70-110µm long x 2-3µm thick. Occasionally, large, bayonet-like, oxea can occur with a sharp bend in the middle, up to 200µm long x 7-10µm thick.	
Voucher	BELUM : Mc3. Arranmore, Donegal.	
Habitat	This sponge tends to grow in the shallow sublittoral, where it is characteristic of mixed sediments, growing upright (?) in small patches on shells and ascidians, and on horizontal rock; often found in sea lochs. It has been recorded as "often half buried in mud and sediment"- which induces longer oscular tubes (?). On the shore it may be found in situations where it is "left dry at all tides" (?).	
Distribution	"Arctic; Atlantic coasts of Europe; Mediterranean; etc."	
Identity	Superficially it can be confused with several other branched species of <i>Leucosolenia</i> (see note under <i>L. complicata</i> ).	



References	Arndt, 1935, p.9. Burton, 1963, p.173. Dendy and Row, 1913, p.723. Minchin, 1904[1905], p.373. Topsent, 1936a, p.33, as <i>L. botryoides</i> var. <i>variabilis</i> .
Source	S.M. Stone. Editors D. Moss, B.E. Picton.

### ***Sycon ciliata* (Fabricius, 1780:448) sensu Burton 1963.**

Family	SYCETTIDAE
Synonyms	In Burton (1963) this is one of a number of 'Named Forms' grouped under <i>Scypha ciliata</i> . As with Burton's other groupings of forms in the Calcarea it may turn out to consist of a number of distinct species.
Form	Tubular, usually single, but clusters of separate individuals often occur together, up to 9cm long (though usually 1 - 3 cm).
Photographs	Lee's Wreck, Strangford Lough. (B.E. Picton)
Colour	Off white, grey or brown.
Smell	None
Consistency	Moderately soft, though can be firmer.
Surface	Usually finely papillate and hairy, though occasionally smooth. If smooth it may be impossible to separate from <i>Grantia compressa</i> (q.v.).
Apertures	There is a single terminal oscule, which is normally fringed with a crown of spicules.
Contraction	Not noticeable.
Skeleton	The ectosomal skeleton is a tangential layer of small triradiates with long straight oxea projecting beyond the surface. The skeleton of the chamber layer consists of regularly overlapping quadriradiates. There is an endosomal skeleton of larger triradiates. A crown of oxea surrounds the terminal osculum.
Spicules	Triradiates (a) are of several size classes, with larger ones in the endosomal layer. Quadriradiates of the chamber layer, are of two types, (b) with apical rays pointing into the ectosome, and (c) with short curved apical rays projecting into the central atrium. Oxea (d), are long and thin, straight, and tapering gradually to pointed extremities.
Voucher	BELUM : Mc7. Strangford Lough, Down.
Habitat	Mainly on the shore, under overhangs near low water. Common in shallow sublittoral, present in deeper water.
Distribution	Arctic to Gibraltar.
Identity	Identifications by eye are usually correct, though beware of the species listed below. Outer surface must be finely papillate (use x10 hand lens). In this species the papillae are the free ends of the water pumping (flagellate) chambers. The species described below may be confused with <i>Sycon ciliata</i> (see also Burton, 1963:359-442).  <i>Grantia compressa</i> (q.v.). <i>Sycon ciliata</i> (normally finely papillate) may have a smooth surface and <i>G. compressa</i> (normally flat) may be cylindrical. There seems to be an overlap in external appearance between these two species. Both are common on most shores, in the same sort of habitats.

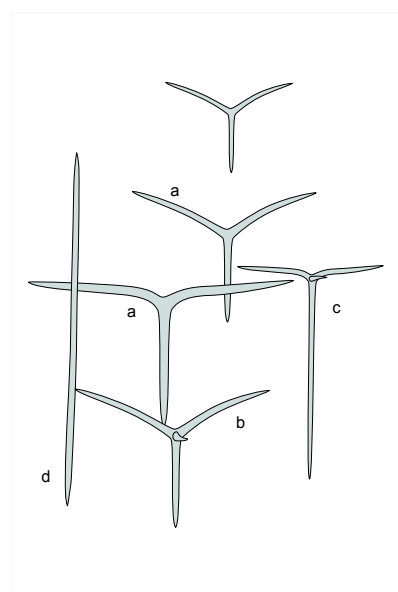

*Leuconia johnstoni* (q.v). This species has tubular chimney-like lobes but these are joined by a common base, and there are short rims to the terminal oscules.

References Arndt, 1935, pp.10-14.  
Burton, 1963, pp.141, 359-442.

Source J.D.. Guiterman, (G. Ackers). Editors J.D. Guiterman. D. Moss, B.E. Picton.

## ***Grantia compressa* (Fabricius, 1780:488)**

Family GRANTIIDAE

Synonyms Treated by Burton (1963:442) as being one of several 'Named Forms' comprising *Scypha compressa* (Fabricius, 1780), the name which he regarded as valid for the whole complex.

Form Flat, like a small hot water bottle, but may be tubular, or composed of contorted flat lobes; with a very short stalk.

Photograph

Colour White or occasionally brown.

Smell None.

Consistency Moderately firm, can be bent through 180 deg. without breaking.

Surface Smooth, has a moderately high friction when stroked.

Apertures There is usually a single, smooth-rimmed, terminal oscule. Occasionally there may be several oscules along the margins.

Contraction Not noticeable.

Skeleton The ectosomal skeleton is a tangential layer of triradiates with 'tufts' of oxea projecting beyond the surface. The skeleton of the chamber layer consists of regularly overlapping triradiates. There is an endosomal skeleton of paired rays of triradiates and a tangential layer of triradiates and quadriradiates lining the central atrium.

Spicules These are calcareous. Ectosomal triradiates (a) have rays 100-120 x 8µm, oxea (b) (resembling hockey sticks) are 100-300 x 8µm. Overlapping triradiates (c) have paired rays 80-120 x 8µm and basal rays 200-300µm. The endosomal triradiates are 100-150 x 5-8µm; quadriradiates 100-150 x 5-8µm with apical rays 40-80 x 8-12µm.

Voucher BELUM : Mc104. Portrush, Co Antrim.

Habitat The main habitat is the sea shore where specimens are found attached to the underside of overhangs, often in abundance; they also occur commonly in the shallow sublittoral, e.g. on kelp stipes (? often associated with red algae). In the east Atlantic "from littoral to 288m".

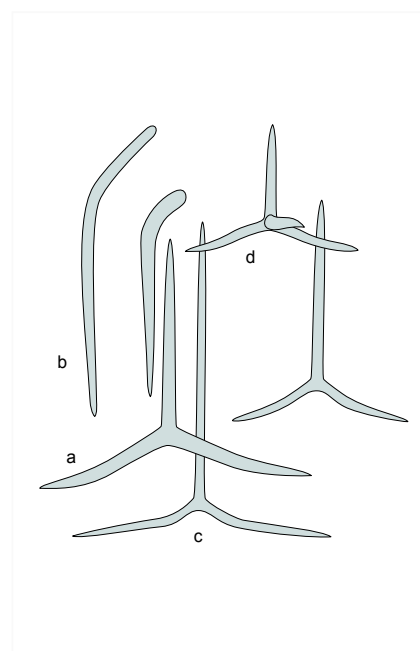

Distribution A common species in the British Isles. Arctic to Channel Islands.

Identity By eye alone, provided specimen is simple, flattened and has a smooth surface. Many other forms exist and these need to be checked microscopically. There is considerable overlap between *G. compressa* which may be tubular instead of flat, and *Sycon ciliata* which may have a smooth outer surface instead of a finely papillate one.



References	Arndt, 1935, p.15 Bowerbank, 1874,p.1. Burton, 1963, p.442 Dendy and Row, 1930, p.760.
Sources	J.D. Guiterman, S.M. Stone.
Editors	J. D Guiterman, D. Moss, B.E. Picton.

### ***Sycandra utriculus* (Schmidt 1869:93)**

Family	GRANTIIDAE	
Synonyms	None in common use, although Burton gives quite a list which has not been repeated here. This species was treated by Burton (1963:447) as being one of several 'Named Forms' comprising <i>Sycon compressa</i> (Fabricius, 1780), the name which he regarded as valid for the whole complex.	
Form	Variable, often basically a thin walled, laterally compressed cylindrical or pear shaped (photo 51) bag (the walls are thicker and almost muscular in comparison with usual <i>G. compressa</i> ). 'Thin' is used relative to the overall size of the sponge - the walls are thick when compared to those of the usual <i>Grantia compressa</i> . It hangs from the point of attachment. (Note orientation in photographs). It can grow from 12-15 cm long, the largest specimens seen being 5cm in diameter and in excess of 1m long. There is also a more lobate form (photos 52,53). There is a very short stalk.	
Photographs		
Colour	Beige (alive or in alcohol).	
Smell	Not noticeable.	
Consistency	Firm but thin walled.	
Surface	Smooth, slightly velvety.	
Apertures	Usually a single terminal oscule, which is naked (i.e. with no collar of spicules).	
Contraction	Will deflate, but no overall shrinkage.	
Spicules	Oxea ca. 500µm, triradiates with 100-200µm rays; quadri-radiates are also present, with rays 150-200µm.	
Voucher	BELUM : Mc2127. Churchill causeway, Orkney. Coll. D. Moss.	
Habitat	Only recently known from two sites, in each case on vertical or overhung side of wreck in 5-20m. No current. Shallow site was exposed to moderate occasional swell.	

Distribution	Recently found in Orkney on Scapa Flow block ships (voucher specimens). "Atlantic, N of UK!" Probably reaching southern limit off Northern Scotland. Earlier recorded from Shetland and Faeroes.
Identity	The large specimens are unusually large for <i>Calcarea</i> and larger bag-like ' <i>Grantia</i> ' forms in UK waters are likely to be this species. Smaller specimens could be confused with <i>G. compressa</i> .
References	Burton, 1963, p.447 Dendy and Row, 1913, p.749.
Sources	D. Moss, S.M. Stone.
Editors	R. Earll, D. Moss, B.E. Picton.



### *Leuconia gossei* (Bowerbank, 1862:1092)

Family	GRANTIIDAE
Synonyms	<i>Leucandra gossei</i> (Bwk., 1862) Haeckel, 1872:177. Treated by Burton (1963:505) as being one of several 'Named Forms' comprising <i>Aphroceras ensata</i> (Bowerbank, 1858:295), the name which he regarded as valid for the whole complex.
Form	Massive, lobed or encrusting.
Photograph	Merope Rocks, N Padstow, West Cornwall & Scilly, England. (B.E. Picton)
Colour	White/beige.
Smell	None.
Consistency	Firm, brittle, hard, breaks if bent.
Surface	Irregular in profile. There is a rough feel to it although it is not hispid.
Apertures	Oscules are few in number and found at the tops of lobes. They have raised rims but no collar of spicules, and may become subfistulose.
Contraction	None noticeable.
Skeleton	Ectosomal skeleton is a tangential layer of triradiates, with oxea which lie obliquely, without projecting beyond the surface. The skeleton of the chamber layer consists of irregularly arranged triradiates, occasionally quadriradiates. The endosomal skeleton is a tangential layer of quadriradiates which line the canals.
Spicules	Spicules are calcareous. The ectosomal triradiates (a) are symmetrical with rays 70-100µm. The ectosomal oxea (b) are large and distinctively fusiform in shape, 400-600µm long. Triradiates of the chamber layer (c) have rays 70-200µm long and the endosomal quadriradiates (d) 100-120µm.
Voucher	BELUM : Mc12. Padstow, N. Cornwall.
Habitat	This species is mainly found in the infralittoral in clean water and seems to be uncommon.
Distribution	"British Isles; Atlantic coasts of France and Portugal." Probably confined to SW of the British Isles.
Identity	Distinctive in having a massive, lobed growth form rather than the tubular form of most <i>Calcarea</i> . The texture and white coloration combined with the calcareous spicules are characteristic.

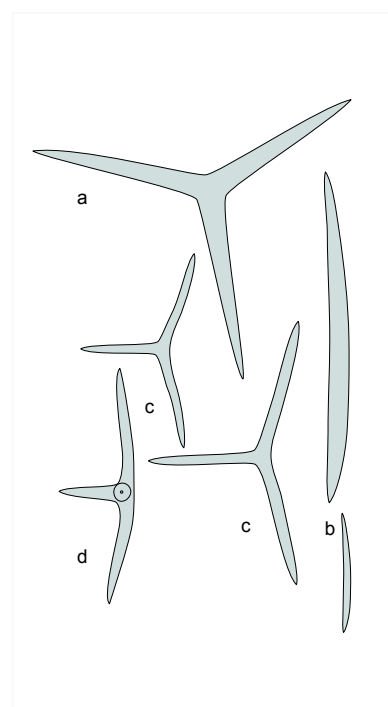

References Bowerbank, 1874, p.13, pl.6, figs. 6-8, as *Leucogypsia*.  
Burton, 1963, p.505.  
Dendy & Row, 1913, p.770.  
Topsent, 1937, p.9.

Source S.M. Stone. Editors D. Moss, B.E. Picton.

## ***Leuconia nivea* Grant, 1826:339**

Family GRANTIIDAE

Synonyms *Leucandra nivea* (Grant, 1826) Haeckel, 1872:211. Treated by Burton (1963:273) as being one of several 'Named Forms' comprising *Leuconia barbata* (Duchassaing & Michelotti, 1864:111), the name which he regarded as valid for this whole complex.

Form Encrusting sheets to cushions with lobes and ridges.

Photographs Geo Shunadal, Boreray, St Kilda. (B.E. Picton)

Colour White, pale grey.

Smell None.

Consistency Firm, crisp, friable.

Surface Smooth.

Apertures Small, distributed along the tops of lobes or ridges, "naked" (i.e. without collar of spicules).

Contraction None.

Skeleton The ectosomal skeleton consists of several tangential layers of triradiates; the skeleton of chamber layer is of triradiates and microxea, irregularly arranged. The endosomal skeleton, and linings of exhalant canals, are tangential layers of quadriradiates.



Spicules The ectosomal triradiates (a) have rays ca. 120µm long, those of the chamber layer (b) 50-1200µm; microxea (c) are 40-60µm long. The endosomal quadriradiates (d) are sagittal and have paired rays ca. 20µm long and basal ray ca. 60µm.

Voucher BELUM : Mc1778. St. Kilda, W. Scotland.

Habitat In strong water movement beneath boulders in shallow water and in surge gullies on vertical rock surfaces.

Distribution A common species in the British Isles. "Spitzbergen; Norway; Heligoland; France; Mediterranean. "Littoral to 128m, on rock."

Identity Superficially this species can be confused with *Leuconia johnstoni* (see Burton, 1963:266) and *Leuconia gossei* (see Burton, 1963:505). It would be useful to see if the three species occupy different ecological niches.

References Arndt, 1935, p.19.  
Bowerbank, 1874, p.11, pl.5, figs. 1-8.  
Burton, 1963, p.273.  
Dendy and Row, 1913, p.773.  
Topsent, 1937, p.10.

Source S.M. Stone, B.E. Picton. Editors D. Moss, B.E. Picton.

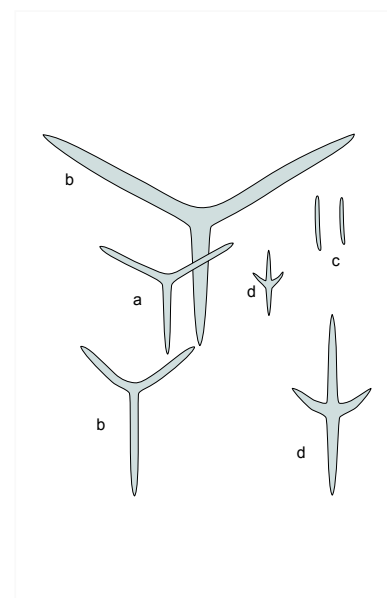

***Leuconia johnstoni* Carter, 1871.**

Family GRANTIIDAE

Synonyms In Burton (1963) this is one of a number of 'Named Forms' grouped under *Leuconia barbata*, the name he considered valid for the whole complex.Form Normally consists of groups of flask-shaped lobes, with terminal oscules, resembling a cluster of *Scypha* sp., but with a common basal crust.

Photographs Lee's Wreck, Strangford Lough. (B.E. Picton)

Colour White, beige.

Smell None.

Slime None.

Consistency Firm.

Surface Even, non-hispid.

Apertures Oscules at tips of lobes, with fringe of short, even spicules.

Contraction None.

Skeleton The ectosome has a tangential layer of triradiates and the facial rays of large quadriradiates, with groups of microxea and quadriradiates. The endosomal skeleton consists of small quadriradiates. The skeleton of the chamber layer consists of scattered triradiates and small quadriradiates.

Spicules Spicules are calcareous. Ectosomal triradiates (a) have rays 200-300 x 15-20µm. Triradiates of chamber layer (b) have rays 100-1000 x 10-70µm. Large ectosomal quadriradiates (c) are ca. 650 x 80µm (ectosome); sagittal quadriradiates of two types, (d) 30-40µm (paired rays), 60µm (basal and apical) x 8µm (chamber layer); and (e) 250 x 6µm (associated with microxea in ectosome). Endosomal quadriradiates (f) with rays 200-300µm. Microxea (g) are ca. 60-80 x 5µm.

Voucher BELUM : Mc1843. Strangford Lough, Down.

Habitat Vertical surfaces of rocks and wrecks in sheltered conditions, even with moderate tidal streams.

Distribution British Isles (? extending to N. of Scotland, E. coast of UK?). Channel coasts of France, Spain.

Identity Can be confused with *Leuconia gossei* (Burton, 1963, p.505) and *Leucosoleniaánivea* (q.v.). The presence of sagittal quadriradiates in the endosomal layer, with large quadriradiates in the ectosome, is diagnostic.

Reference Burton, 1963, p.266.

Source D. Moss, B.E. Picton.

Editor D. Moss, B.E. Picton.

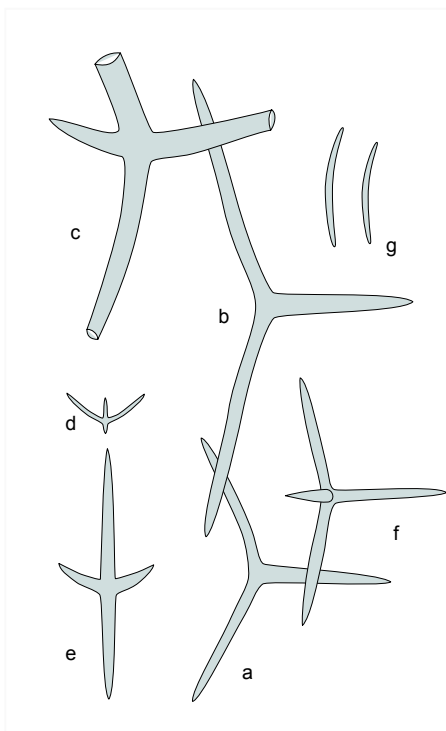

***Oscarella cf. lobularis* (Schmidt, 1862:80)**

Family	OSCARELLIDAE
Synonyms	<i>Halisarca lobularis</i> Schmidt, 1862:80.
Form	A thin ‘bubbly’ sheet over boulders or rock faces. Small patches 4cm across to large patches 30cm or more across.
Photographs	Inishvickillaun, Blaskets, Co Kerry. (B.E. Picton)
Colour	Pale yellow, orange, sometimes with red pigment on surfaces exposed to light or in shallow water. Colour varieties including red, brown, green, blue and violet have been reported from the Mediterranean, but recent work by Boury-Esnault <i>et al.</i> (in prep.) has shown these to represent two separate species. These were treated as separate colour varieties in the past. This will result in some name changes as the true <i>O. lobularis</i> is one of these Mediterranean species, and a new name will have to be sought for the British species.
Smell	None.
Consistency	Very soft and fragile, “gelatinous”.
Surface	Covered with bubble-like projections - lobulate. These lobules measure 0.5 - 1cm in diameter. Translucent when alive. ‘Slippery’.
Apertures	Widely scattered large oscules with a delicate chimney-like structure, which collapses and is lost in preservation.
Contraction	When collected it becomes a thin opaque sheet and loses its lobulate appearance.
Skeleton	None. Without spicules, spongin fibres or foreign inclusions which might strengthen the soft matrix. Large cavities and lacunae permeate the body.
Spicules	None.
Voucher	BELUM : Mc324. Strangford Lough, Down.
Habitat	“Littoral to 300m+”. Covering tops of boulders in sheltered areas of moderate current, e.g. Strangford Lough. On vertical rock faces in Lough Hyne; and on chalk and clay cliff faces of moderate current in Sussex. Sometimes found in sheltered conditions with little current or wave action, e.g. Summer Isles. Found abundantly on fully exposed bare rockfaces at St. Kilda, overgrowing <i>Lithothamnion</i> .
Distribution	A common species in the British Isles. “Arctic; Belgium; France; Mediterranean”, Azores. In the U.K. known recently from Strangford Lough; Lough Hyne; Summer Isles; Sussex; Dorset, St Kilda, W. Scotland.
Identity	The lobulate surface together with delicate oscular chimneys, combined with a delicate texture and lack of skeleton, is diagnostic underwater. The only other common British sponge which lacks a mineral or spongin skeleton is <i>Halisarca dujardini</i> (q.v.), which can be distinguished with a microscope from <i>Oscarella</i> by its large and elongate choanocyte chambers, with the flagella sometimes visible. However differences in external appearance (presence of a cuticle and lack of lobules, giving a smooth, rather slimy, toffee-like appearance) probably are great enough to make confusion unlikely. A species of <i>Hexadella</i> has recently been found near Rathlin Island, N. Ireland. It differs from <i>Oscarella</i> in having a surface with radiating fibre-like lines and also has no spicules.
References	Arndt, 1935, p.23. Topsent, 1896, p.561.
Sources	B.E. Picton, S.M. Stone, (G. Ackers, F.A. Dipper).
Editors	D. Moss, B.E. Picton.



***Dercitus bucklandi* (Bowerbank, 1858:288)**

Family PACHASTRELLIDAE

Synonyms None in common use.

Form Cushion to massive-lobose, filling crevices in vertical rock faces. Appearance as of a black membrane stretched across the back of crevices.

Photographs St. John's Point, Donegal. (B.E. Picton). Overgrown partially by *Amphilectus fucorum*.

Colour Black to dark grey-brown externally. Usually a greyish-yellow internally.

Smell None.

Consistency Moderately firm but compressible and spongy when *in situ*.

Surface Smooth but often has ridges looking like stretch-marks. The surface is usually concave.

Apertures Oscules are flush with the surface, variable in size and usually collected into groups towards the centre of the sponge.

Contraction Not noticeable.

Skeleton Main skeleton confused, of randomly arranged calthrops, with microxea and toxa near the surface. There are many pigment cells with black inclusions evident in sections.

Spicules Megascleres are large calthrops (a) with rays 250-300µm, often with axial canals seen clearly running through the rays. Microscleres are microspined or microtuberculate microxea (b) ca. 25µm and toxa (c) 55-80µm.

Voucher BELUM : Mc458. St John's Pt, Donegal.

Habitat In crevices in vertical rock faces in clean water. Particularly common on limestone substrata. "From ELWS to a few metres subtidally, in rock pools and caves."

Distribution British Isles and France. Distribution poorly known - it has not often been dredged up because of its habitat! Known recently from : west coast British Isles; common in the south west; W. Sussex. Not on east coast of UK?

Identity The black colour and the habit of bridging crevices makes it unlikely to be confused with anything else. Other black sponges do exist so it is necessary to check spicule categories for a positive identification. Bowerbank's 1874 figure "is a magnificent portrait of a piece of rock from cliffs around Torbay, with small portions of sponge suspected to be present on its edges" (Burton)!

References Hiscock, Stone and George, 1983 [1984], p.19.  
Topsent, 1896, p.528.

Sources D. Guiterman, S.M. Stone, B.E. Picton.

Editors D. Guiterman, D. Moss, B.E. Picton.

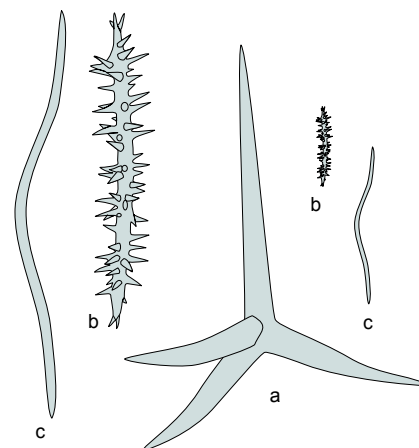

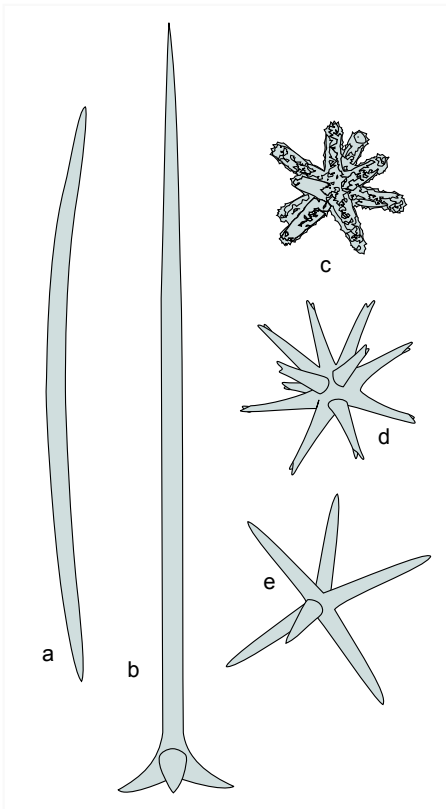

***Stelletta grubii* Schmidt, 1862:46**

Family	STELLETTIDAE	
Synonyms	<i>Tethea collingsii</i> Bowerbank, 1866:87, <i>Tethea schmidtii</i> Bowerbank 1866:89, <i>Ecionemia coactura</i> Bowerbank, 1874:269. See also Arndt for further synonyms.	
Form	Massive-lobose, rounded or irregular in outline, to 30 cms or more across. Many specimens develop a circular depression in the upper surface. Often heavily overgrown with other sponges (including <i>Antho involvens</i> , <i>Haliclona</i> spp., <i>Clathrina coriacea</i> ), <i>Dendrodoa</i> , miscellaneous hydroids and bryozoans, and consequently not obvious to the eye when seen <i>in situ</i> .	
Photograph		
Colour	Pale grey, off white or cream tinged with red-brown at edges when clean, but usually discoloured by silt. In section living material has a pale grey-white rind and the interior is strikingly different in colour, ochre or cream-coloured.	
Smell	A characteristic slightly sharp smell.	
Consistency	Very firm but somewhat compressible.	
Surface	Even or conulose, hispid. Rough to the touch, like sandpaper, because of penetrating heads of large oxea and trianes (visible at 40x with stereo microscope).	
Apertures	Oscules not obvious, “small when seen”.	
Contraction	Not noticeable.	
Skeleton	Choristid, with a well developed cortex, and densely packed, radially arranged tracts of oxea and trianes. Microscleres are scattered in the choanosome and form a layer in the cortex. This hard ‘rind’, which is up to 2 or 3mm thick, almost peels away from the interior. The choanosome has a slightly softer texture and consists mainly of oxea with relatively fewer trianes.	
Spicules	Megascleres are oxea (a), average length 1000-(1035)-1500µm “average (2000µm)”, and long shafted orthotriaenes (b) 875-(975)-1175µm. Microscleres are euasters of three types: tylasters to strongylasters (c) with microspined rays (6-(10)-12µm diameter) in the cortex, and oxyasters of two types, 12µm with multi-spined tips (d) and 40µm with few rays (e) in the choanosome. The large oxyasters may be reduced to one or two rays, so that they look like short tylostyles or centrotylote oxea.	
Voucher	BELUM : Mc94. Mulroy Bay, Co Donegal.	
Habitat	Usually found on dark vertical or overhung rock faces, caves, etc., usually in the presence of some silt. Seems to avoid the light. “Littoral to 135m on rock”. May be locally common in shallow water (below CD - 2m), where moderately exposed to, or sheltered from, wave action.	
Distribution	In UK known recently from Raven’s Point, Anglesey; Mulroy Bay & St John’s Point, Co. Donegal; Rathlin Is, Co. Antrim. Arndt says “Shetlands (?)”; Atlantic coast of Great Britain; France; Spain: Mediterranean”.	
Identity	Overgrown appearance and division into rind and creamier interior gives an initial tentative identification, but microscopic examination is necessary to be certain. There is a possibility of confusion with other species of <i>Stelletta</i> and especially with <i>Stryphnus ponderosus</i> , (Bowerbank, 1866), (q.v.) which may only be resolved by careful comparison of spicules. <i>Stryphnus</i> has short-shafted trianes (i.e. dichotriaenes, sometimes modified	

to orthotriaenes), and does not possess such a well developed rind. This is a good field character, if a small piece of the sponge is cut off. *Stelletta lactea* Carter, 1871:9 has long-shafted dichotriaenes in addition to the orthotriaenes of *Stelletta grubii*, and there are bundles of raphides in the body of that sponge.

References Arndt, 1935, p.26.  
Topsent, 1894, p.345.

Sources D. Moss, B.E. Picton, S.M. Stone. Editors D. Moss, B.E. Picton.

### ***Stryphnus ponderosus* (Bowerbank, 1866: 56)**

Family STELLETTIDAE

Synonym *Ecionemia ponderosa* Bowerbank, 1866: 56; *Ancorina ponderosus*.

Form Massive-lobose, with rounded lobes, or irregular in outline; occasionally goblet or cup-shaped. Often there is a central hole the size and shape of an orange in large specimens. Up to 40cms in diameter. Almost invariably coated with other sponges (e.g. *Antho inconstans*, *Plocamilla coriacea*, *Desmacella annexa*) or bryozoans, and consequently not obvious to the eye when seen in situ.

Photograph Ruecallan, Rathlin Is, Antrim. (B.E. Picton)

Colour Pale greyish brown on the surface and ochre in the interior; "dark brown". Areas of free surface may have a purple-brown coloration.

Smell Characteristically slightly sharp smell.

Slime None.

Consistency Very firm and incompressible.

Surface Areas of free surface are small, tending to be adjacent to the substrate, where coating species have not extended. Even; smooth or more commonly hispid, with occasional conulate patches, high friction, rough to the touch, like sandpaper (because of the heads of the megascleres penetrating the surface).

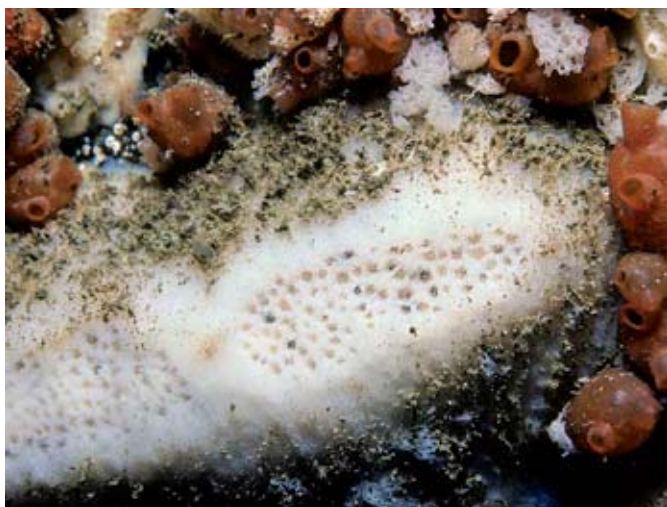

Apertures Groups of 3 to 8 oscules are occasionally present on free surfaces. The oscules are small, up to 1mm in diameter, and flush with the surface.

Contraction Not noticeable.

Skeleton The cortex is thin, less than 0.5mm. It consists of radially arranged, densely packed bundles of dichotriaenes and oxea. Here amphiasters are numerous, oxyasters occasional. The choanosome consists of irregularly arranged oxea, with occasional dichotriaenes. In places the oxea are ordered into radial bundles directed towards the cortex. Oxyasters are numerous, and amphiasters occasional.

Spicules Megascleres are oxea and short shafted dichotriaenes (sometimes modified to orthotriaenes). The oxea (b) are curved to a greater or lesser extent, 1000-(1150)-1250µm; "1200-2500µm" long by 20-50µm wide. The dichotriaenes (a) have shaft lengths of 340-850µm by 25-40µm wide. The ratio of shaft length divided by clade diameter is between 1.6 to 2.3 - hence "short shafted".

Microscleres are amphiasters (d,e) 10-13µm long, and oxyasters (c) 18-26µm in diameter.

Voucher BELUM : Mc1038. Rathlin Island, Antrim.

Habitat On vertical or overhung rock faces, sand and shells, away from direct light, from 1-740m.

Distribution Arctic; Atlantic coasts of Europe, Mediterranean. Fairly

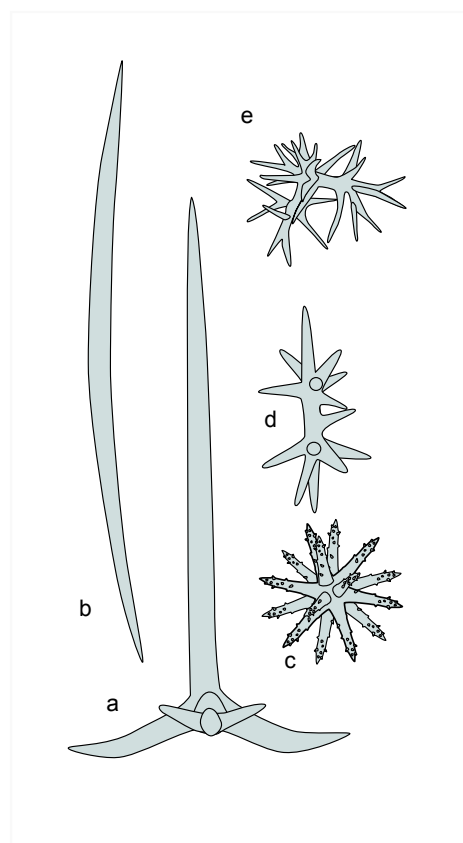

common on vertical cliff faces and limestone caves on north coast of Rathlin Is., Co. Antrim.

- Identity** This species is very similar to *Stelletta grubii* (q.v.) in appearance and habit. The skeletal characteristics are different, most obviously the presence of short shafted dichotriaenes in *Stryphnus ponderosus*. Also, the distinctive hard, pale grey, 'rind' of *Stelletta grubii* is several millimetres thick, and obvious; that of *Stryphnus* is only 0.5mm thick, and inconspicuous. This can be used as a distinguishing character in the field, if a small portion of the sponge is broken off. However, beware of mistaking an epifaunal sponge for 'rind'.
- References** Arndt, 1936, p.27.  
Topsent, 1894, p.365.

**Source** G. Ackers (B. Picton). **Editor** D. Moss. **Draft 1** 3/90

### ***Pachymatisma johnstonia* (Bowerbank (in) Johnston, 1842:198)**

- Family** GEODIIDAE
- Synonyms** None in common use.
- Form** Massive-lobose, hemispherical to irregularly rounded, up to 30cm or more across.
- Photographs** Keem Bay, Achill Island, Mayo. (B.E. Picton)
- Colour** Purple-grey to slate grey to off-white; tends to be darker along rows of oscules. It may be white in dark positions such as caves. The interior is greyish yellow.
- Smell** None.
- Consistency** Firm but slightly compressible.
- Surface** Smooth, with no projections. Just beneath the surface is a hard layer, the 'sterrastral layer' packed with sterraster microscleres.
- Apertures** Oscules rounded, evenly spaced. usually along the tops of the ridges. Rims not raised, flush with the surface.
- Contraction** Not noticeable.
- Skeleton** Choristid with a well developed cortex consisting of an outer layer of densely packed microrhabs, below which is a dense layer of sterrasters. Subradially arranged tracts of strongyloxea and triaenes are most apparent near the surface.
- Spicules** Megascleres are strongyloxea 550-(700)-980 $\mu$ m (sometimes one, or both, of the ends may be pointed to resemble oxea, and sometimes they may be blunt resembling strongyles, with slightly swollen (tylote) ends). Triaenes are short-shafted orthotriaenes with ca. 500 $\mu$ m shafts and 250 $\mu$ m clades, but ana- and protriaenes are lacking. Microscleres: the ectosomal microrhabs are microspined microstrongyles; choanosomal euasters are oxyasters with microspined rays ca. 40 $\mu$ m, and ectosomal euasters are sterrasters ca. 140 $\mu$ m, characteristic of Geodiids.
- Voucher** BELUM : Mc95. Mulroy Bay, Co Donegal.
- Habitat** On bedrock or stable boulders, often on cliff walls projecting into water currents. Can also tolerate a degree of sediment on rock surfaces. "Littoral (ELWS) to 300m." A common species in sites with strong water movement, but also found under overhangs in extreme shelter.

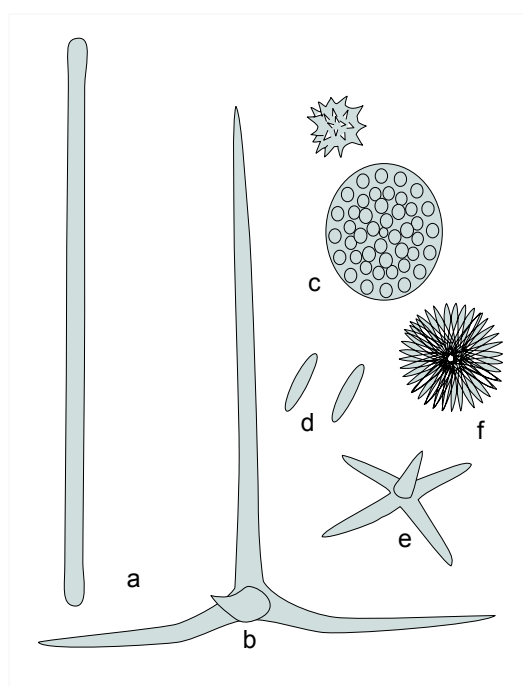

Distribution	“Atlantic coast of Europe; Shetland; Orkney; south to Spain?” Recently confirmed from Orkney and Shetland and ubiquitous on the western and southern coasts of the British Isles. Apparently absent from North Sea coasts of British Isles.	
Identity	The slate grey colour, rounded lobes and evenly-spaced oscules (neat looking), flush with the surface give the sponge a characteristic appearance. If the specimen has a hard sub-surface layer identification by eye is reliable.	
References	Arndt, 1935, p.28. Hiscock Stone and George, 1983[1984], p.19. Topsent, 1894, p.321.	
Sources	D. Guiterman, S.M. Stone, B.E. Picton. Editors	D. Guiterman, D. Moss, B.E. Picton.

### ***Tetilla zetlandica* (Carter, 1872: 417)**

Family	TETILLIDAE
Synonyms	<i>Tethya zetlandica</i> (Carter, 1872: 417), <i>Craniella zetlandica</i> (Carter, 1872: 417), <i>Tethyopsilla zetlandica</i> (Carter, 1872: 417).
Form	Massive-globose, being spherical to hemispherical, slightly flattened at the base. Up to 6cms in diameter.
Photographs	Mc695. Aran Islands, Galway. (B.E. Picton)
Colour	White, “brown, yellow” (? looks whitish in one photograph). ( <i>Tetilla cranium</i> , a similar species, is described as “yellowish white in spirit”).
Smell	? ( <i>T. cranium</i> is described as having an “offensive, ammoniacal odour” when fresh).
Slime	None
Consistency	Firm, incompressible.
Surface	Even, conulate, spinose (the hairs projecting through the conules), with a rough texture exhibiting high friction.
Apertures	Typically, a single oscule at the apex (??).
Contraction	None.
Skeleton	Choristid, with a well developed cortex. The thick radially arranged tracts of megascleres, which can be seen with the unaided eye in torn specimens, run perpendicular to the surface. The cortical skeleton is a dense palisade of the smaller oxea (see below) supporting bundles of protriaenes, which project from the surface at their clad (i.e. rayed) ends.
Spicules	There are four types of megascleres. Cortical oxea are 800-1400µm long, by 50µm wide. Choanosomal oxea are ca. 2560-4600µm long, by 60µm wide, and are longitudinally asymmetrical. The trianes are long shafted, with relatively small rayed ends. The protriaenes are 3490-7100µm long, by 18µm wide. The anatriaenes are ca. 5300-8570µm long, by 25µm, diminishing to 13µm wide.  There are no microscleres.
Voucher	BELUM : Mc695. Aran Islands, Galway.
Habitat	Seated in cup shaped sponges ( <i>Axinella infundibuliformis</i> / <i>Phakellia ventilabrum</i> ), or attached to stones at depths of 15-680metres (recent observations by divers are from ca. 40m).
Distribution	Shetland. Also generally reported from the Arctic, Atlantic, Indian and Pacific Oceans. Known recently from the Aran Islands, Galway Bay and Western Scotland.

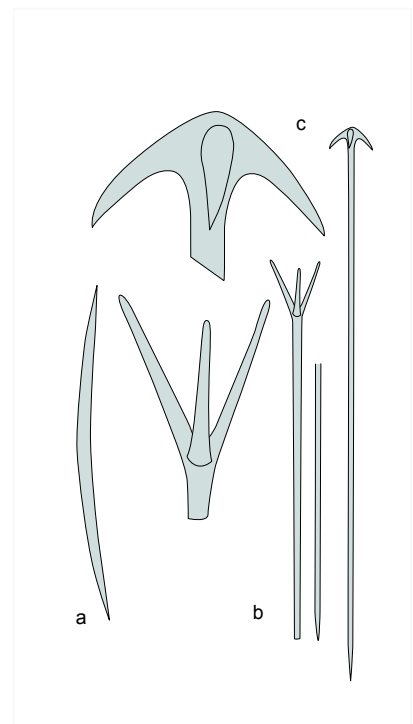

Identity	<i>Tethya aurantium</i> (q.v.) is similar in shape and size, but is usually orange, not as firm and “coarse” as <i>T. zetlandica</i> , and typically found in shallower water. The spiculation of these two sponges is quite different. <i>T. zetlandica</i> is a northern, deeper water sponge, only likely to be encountered occasionally by scuba divers.		
	<i>T. cranium</i> (Muller, 1776: 255) is reported to be identical to <i>T. zetlandica</i> in external appearance, but possesses distorted ‘S’ shaped microscleres called sigmaspires. The similarity between these two sponges has resulted in some authors synonymising <i>T. zetlandica</i> under <i>T. cranium</i> , or making it a variety thereof.		
References	Arndt, 1935, p.24. Bowerbank, 1882, p.39. Sollas, 1888, pps. cix and 55.		
Source	G. Ackers (B. Picton).	Editor D. Moss.	Draft 1 2/90

### ***Tethya citrina* Sarà & Melone, 1965**

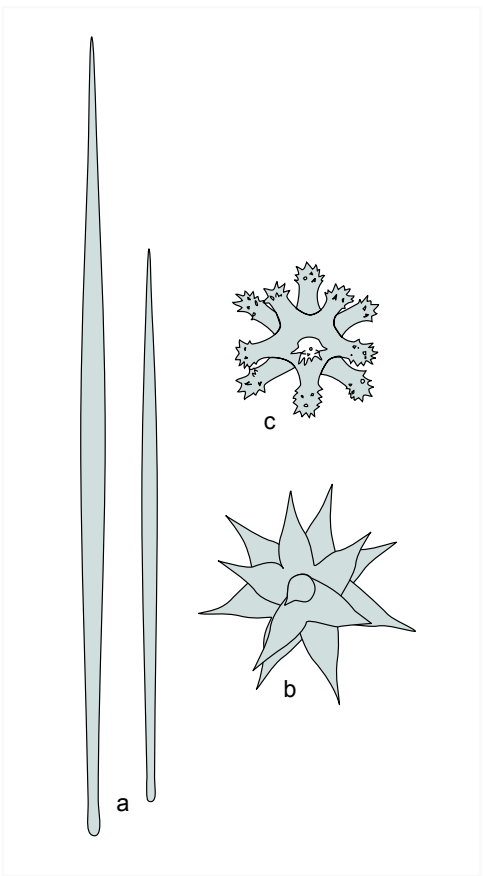
Family	TETHYIDAE		
Synonyms	<i>Donatia lyncurium</i> (Linnaeus, 1767:1295), <i>D. aurantium</i> (Pallas) Gray, 1867:541. <i>Tethya aurantium</i> auctt.		
Form	Massive-globose (usually spherical to hemispherical) up to 6cm in diameter, sometimes with ‘rooting’ processes. Overall appearance like a small orange.		
Photographs	Rathlin Is, Antrim. (B.E. Picton)		
Colour	Most commonly pale to bright yellow, but can be orange.		
Smell	Even when fresh, the interior smells of marine specimens which have been allowed to decay. (Is this a constant feature?).		
Consistency	Moderately firm, moderately elastic. “Compact, firm when contracted.”		
Surface	Tuberculate (“warty”) the tubercles are separated by contractile pore-bearing grooves. Sometimes ‘buds’ are present, found on short stalks on top of these tubercles. Often covered by a layer of silt. Appearance variable, dependent on expansion and contraction. When contracted, can appear smooth and even, faintly marked by meandering striations. These can expand into grooves or channels, leaving ‘islands of tissue’ between, which can be rounded in profile (i.e. tuberculate) or flat (i.e. polygonal in outline).		
Apertures	Usually one oscule, apical, almost opposite to the point of attachment.		
Contraction	Contracts to less than half fully expanded size when removed from water. There have been reports of the surface layer being expanded so as to appear partially separated from the underlying tissues (e.g. SMS, pers. obs.). Information on this phenomenon would be welcome.		
Skeleton	Choristid, with a well developed cortex. The thick radially arranged tracts of megascleres, which can be seen with the unaided eye in torn specimens, run at right angles to the surface, and terminate in a surface tubercle without piercing the surface.		
Spicules	Megascleres are strongyloxea (a) (stylote or tylote) 510-(680)-850µm in length. Microscleres are euasters; with ca. 30µm diameter spherasters (b) forming a distinct layer in the		

'muscular' cortex, and with strongylasters with microspined tylote rays (c), ca. 12µm in diameter, predominating in the choanosome.

Voucher	BELUM : Mc181. Strangford Lough, Down.
Habitat	On rock surfaces usually in open water, although it has been reported in harbours. A common species on horizontal or sloping rocky surfaces in clean water but tolerant of silt.
Distribution	"Arctic; N. Atlantic; Mediterranean. Littoral to 930m." Apparently absent from North Sea coasts of British Isles. Common on western and southern coasts.
Breeding	Stalked buds produced between July and September (?).
Identity	Identification by sight alone stands a good chance of being correct. <i>Suberites</i> sometimes adopts the same form but has a smooth surface. <i>Tetilla cranium</i> (Müller, 1776:255) and <i>Tetilla zetlandica</i> (this guide) are the same shape and have a rough surface, but are usually bright white in colour. <i>Tetilla</i> species have triaenes and oxea as their megascleres and <i>T. cranium</i> has distinctive distorted 'S' shaped microscleres (sigmaspires).
References	Arndt, 1935, p.30. Hiscock, Stone and George, 1983[1984], p.20. Topsent, 1900, p.294.
Sources	D. Guiterman, S.M. Stone.
Editors	D. Guiterman, D. Moss, B.E. Picton.

### ***Suberites carnosus* (Johnston, 1842:146)**

Family	SUBERITIDAE
Synonyms	(Note <i>Suberites (Hymeniacidon) crustula</i> (Bowerbank, 1866:185) is really <i>Polymastia mamillaris</i> )
Form	In the British Isles this species typically assumes a hollow, contractile, massive-fig shape, attached by a stalk to the substrate. On the Continent a variety of forms have been recognized, graduating from thin sheets and cushions to massive-lobose and even branching forms (see Topsent, 1900, p.233). These forms have yet to be found in British waters and may not be conspecific.
Photographs	Oigh Sgeir, Small Isles, west Scotland. (B.E. Picton)
Colour	Various shades of pale yellow, buff, pale orange and brown.
Smell	Smells faintly of freshly cut <i>Laminaria</i> stipe.
Consistency	Firm and moderately elastic when out of water. Extremely soft when fully expanded under water. Stalk breaks when bent through 20 deg. (when in contracted condition.)
Surface	Smooth, even with a minutely velvety feel. This is most easily detected with the tongue. The upper surface is often lightly coated with silt.
Apertures	Usually one oscule, at the top, but there may be more. If so, they are usually all on the uppermost surface.
Contraction	Very dramatic, contracts to about 1/4 of its fully expanded size when disturbed. Full contraction takes about 15 seconds. Further contraction occurs when the sponge is removed from the water.
Skeleton	Subradiate, the radial arrangement of the spicules being most apparent near the surface. Internally the skeleton is confused, almost halichondroid. There is one type of spicule (tylostyle), of two distinct sizes. The larger (a) constitute the main structural megascleres, whereas the smaller (b) are perpendicularly arranged as plumose brushes (resembling shaving brushes) at the surface. In the stalk region the spicules are condensed to form an axial skeleton.
Spicules	Tylostyles, (a,b) long and thin 330-(410)-500µm, with typical neat suberitid swellings at the head, like pins. In any given specimen spicules are of a narrower size range than <i>Suberites ficus</i> (q.v). No microscleres.



Voucher	BELUM : Mc27. Strangford Lough, Down.
Habitat	Usually growing vertically attached to horizontal rock surfaces. Sometimes found in muddy places attached to shells or stones buried in the mud, e.g. in harbours and Scottish and Irish sea lochs.
Distribution	“Arctic; Atlantic coasts of Europe; Mediterranean; etc.” See the following Table for possible features distinguishing between this species and <i>Suberites ficus</i> . Some species which can be confused with <i>Suberites carnosus</i> and <i>Suberites ficus</i> are also given there. The brief notes are not designed to provide identification information, but are included to prevent the species mentioned from being confused with the two <i>Suberites</i> species under discussion.
References	Arndt, 1935, p.38 Cabioch, 1968, p.216. Hiscock, Stone and George, 1983[1984], p.20. Topsent, 1900, p.233
Sources	J.D. Guiterman, S.M. Stone, (G. Ackers, B.E. Picton).
Editors	D. Moss, B.E. Picton.

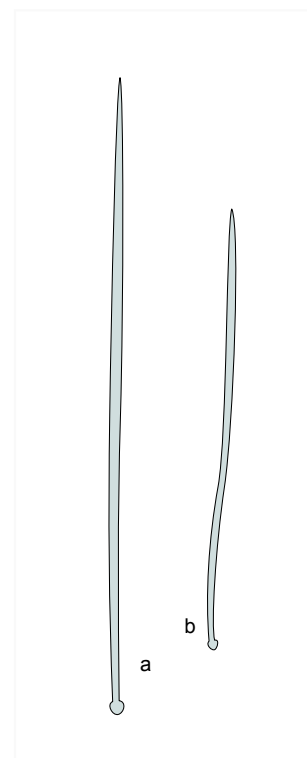

A table summarising the differences between *Suberites carnosus* and *Suberites ficus*. (Based on criteria communicated by S.M. Stone).

Character	<i>Suberites carnosus</i>	<i>Suberites ficus</i>
<b>Texture when undisturbed underwater.</b>	If fully expanded very soft, does not sink when broken off.	Firm even when fully expanded and sinks when broken off.
<b>Contraction</b>	Contracts to 1/4 of fully expanded size when prodded.	Contracts to 3/4 of fully expanded size when prodded.
<b>Shape</b>	Usually fig-shaped or spherical; often stalked.	Usually lobed, not stalked; occasionally fig-shaped.
<b>Surface</b>	Slight velvety feel to tongue. This is not always obvious.	Surface lacks velvety feel to tongue, but there is high friction due to the palisade.
<b>Skeleton of surface</b>	Plumose bundles of spicules at surface.	Bundles unite at the surface to form a palisade.
<b>Skeleton of deeper tissue</b>	Less dense, confused, no tendency to form a multi-spicular net: less of a size range in any one specimen.	More dense, more ordered, tends to form bundles arranged in a net (use a stereo microscope on cleared section); greater size range in any one specimen.
<b>Centrotylote microscleres</b>	Not present.	Present amongst the tips of the palisade spicules.

***Suberites ficus* (Linnaeus, 1767 : 1295)**

Family SUBERITIDAE

Synonyms *Suberites domuncula* (Olivi, 1792:241) (The name used for this species in previous editions of this guide) is now considered to be a distinct species, with no microscleres and possibly confined to the Mediterranean. Recent work in the Isle of Man has shown three distinct species to be present there on the basis of electrophoretic evidence. These have been named provisionally; *Suberites pagurorum* on hermit crabs, *Suberites rubra* a red crust on *Aequipecten opercularis* and *Suberites lutea* a yellow crust also on *Aequipecten*. The massive form described here was not investigated.

Form Massive-lobose, massive-globose, or cylindrical with a ridged appearance in large specimens.

Photographs 1. Tearaght Is., Blaskets, Kerry (*S. ficus*).  
2. Loch Resort, W. Harris, Outer Hebrides (*Suberites pagurorum*).

Colour Usually orange, sometimes intermediate shades of yellow, orange or brown. It has been reported as white, white-grey, grey or green (the latter in patches, caused by the presence of symbiotic algae). The interior is yellow.

Smell Faint, of freshly cut cucumber.

Consistency Firm, moderately elastic, softer when undisturbed in water. Elongate forms break when bent through 20 degrees.

Surface Smooth, not velvety (cf. *Suberites carnosus*), but presents high friction when the tongue is run over it. "Hirsute, even".

Apertures One to many (5, or even more) oscules, mostly at the tops of the lobes (see e.g. photo 31) but other positions are possible. The oscules are large and the excurrent canals can be easily seen joining below the oscules.

Contraction Noticeable: when removed from the water the sponge contracts to about 3/4 of its size when undisturbed underwater.

Skeleton Subradiate, the radial arrangement of the spicules being most apparent near the surface. Internally the skeleton is confused, almost halichondroid. There is one category of spicule (tylostyle), divided into two size groups. The larger constitute the main structural megascleres, whereas the smaller are perpendicularly arranged as a dense palisade at the surface.

Spicules Megascleres are tylostyles of 2 sizes, (a) 320-(380)-420 x 6µm and (b) 100-(158)-225 x 2.5µm. Microscleres are microrhabds, ie. centrotylote microstrongyles (c) (25-(48)-70µm), which need careful searching of the ectosome to be seen, amongst the tips of the palisade spicules (i.e. right at the surface).

Voucher BELUM : Mc151. Strangford Lough, Down.

Habitat "LWS to 1330m.?" The large form is usually found where there are tidal currents, and/or oceanic water conditions although it can be found in still water in sites where there is no freshwater influence, such as Lough Hyne. On rock, wreckage. The form now known as *Suberites pagurorum* grows around empty gastropod shells inhabited by hermit crabs, and the other two recently named forms grow on *Aequipecten* valves (see Synonymy above). In still water it sometimes occurs free-living, as a large slipper-shaped mass, presumably having initially settled on a piece of hard debris which is subsequently enveloped.





Distribution	Widespread throughout Arctic and Atlantic in the northern hemisphere. The form illustrated here is not uncommon on western coasts of the British Isles.
Identity	This seems to be a species where field characters and electrophoretic evidence are more useful than spicule morphology. Traditionally the presence of centrotylote microscleres was considered diagnostic. The table given under <i>Suberites carnosus</i> sets out the differences between <i>Suberites carnosus</i> and <i>Suberites ficus</i> . Before coming to a conclusion, make sure that all the characters fit. The presence of centrotylote microscleres is only a confirmation of the <i>Suberites ficus</i> species group. Please report if any characters are unreliable. Brief notes on some other species which might be confused with <i>Suberites carnosus</i> or <i>Suberites ficus</i> are given below.
References	Arndt, 1935, p.39. Hartman, 1958a, p.3. Hiscock, Stone and George, 1983[1984], p.20. Topsent, 1900, p.203.
Sources	D. Guiterman, S.M. Stone, B.E. Picton, (G. Ackers). Editors D. Guiterman, D. Moss, B.E. Picton.

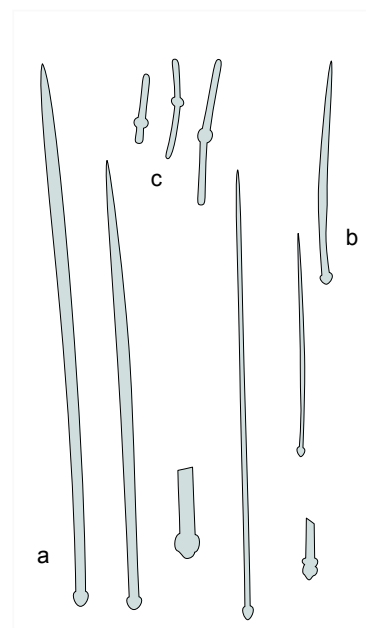

**Brief description of some species that might be confused with *S. carnosus* and *S. ficus*.**

*Suberites elongatus* Ridley & Dendy, 1886 p.486. Main structural megascleres are styles with smaller surface brushes of tylostyles. So far recorded as a deep water species.

*Suberites gibbosiceps* Topsent, 1904 p.125. Surface villose. Main structural megascleres are tylostyles with irregular, often tuberculate heads. Smaller ectosomal palisade tylostyles have more regular heads. So far recorded as a deep water species.

*Laxosuberites* spp. Distinguished from *Suberites* spp. by lacking a size difference distinguishing ectosomal spicules from the choanosomal ones.

*Pseudosuberites* spp. Like *Laxosuberites*, with one size of tylostyle; the surface spicules are arranged tangentially. See *Pseudosuberites sulphureus* in this guide.

*Quasillina brevis* Has a feebly developed choanosomal skeleton, but a well-developed cortical skeleton of tangential megascleres supporting surface brushes of smaller but similar spicules. Megascleres are stronglyloxea to subtylostyles.

---

### ***Suberites massa* Nardo, 1847: 4**

Family	SUBERITIDAE
Synonyms	None.
Form	Massive-lobose, often having the form of a flattened hemisphere, composed of a network of anastomosing plates and ridges, with the orange crests showing through but the interstices usually being filled with silt. The whole sponge may approximate the form, appearance and size of a human brain. At lateral growth areas repent and compact coalescing branches can occur. In places, tangled masses of these branches can themselves form the body of the sponge. Attachment to the substrate may be discontinuous. Size up to 10cm thick by 30cm in diameter, but smaller “fist-sized” specimens are more typical.
Photograph	The Fleet, Dorset, boathouse wall, 1m, 21cm. (G. Ackers)
Colour	Bright to buff orange; yellow (butter colour). “Yellow-orange in the basal regions, becoming more brown in top”. Eventually turns grey in alcohol.



Smell	Very slight, sweetish.
Slime	None.
Consistency	Compact, firm.
Surface	An irregular mass of laterally coalescing papillae-like branches, which may be the only part of the sponge visible through silt <i>in situ</i> . Smooth, moderate friction.
Apertures	Oscules are borne at the ends of the papillae and are clearly visible under water. The papillae collapse on collection and the oscules are then no longer apparent.
Contraction	Noticeable.
Skeleton	Subradiate, the radial arrangement being apparent near the surface, where the spicules are loosely arranged into ascending bundles. The points of the spicules penetrate the sponge surface to form a sub-palisade layer, ca. 180µm deep.
Spicules	Megascleres are large tylostyles in the range 160-950 x 4-16µm. They are not differentiated into two size ranges, but a large number fall within the 550-850µm range. A high proportion of the spicules are straight, with only a few being slightly curved. Vermiform spicules have also been reported. The heads are often mucronate to a greater or lesser extent, but a few are smoothly rounded. There are no microscleres.
Voucher	BELUM : Mc657. Off Roscoff, English Channel. Coll. L. Cabioch, S. M. Stone.
Habitat	Found in the silty brackish water of harbours, estuaries and lagoons where there are moderate tidal currents. It colonizes shells (often over-growing them so that the sponge is free-standing), boulders and sea walls or similar structures. Usually sublittoral but in places, especially if shaded, can occur on the lowest shore.
Distribution	Known in the British Isles only on the Channel coast -in the Fleet (Dorset), Poole Harbour (Dorset), and Southampton Water (Hampshire). Also known from the River Morlaix in Brittany, and from the Mediterranean.
Identity	The large size of the tylostyles and estuarine habitat are characteristic. The form could be likened to a large, very ragged <i>Polymastia boletiformis</i> . The stubby branching processes are reminiscent of those of <i>Homaxinella subdola</i> .
References	Arndt, 1935, p.41. Topsent, 1925, p.8.

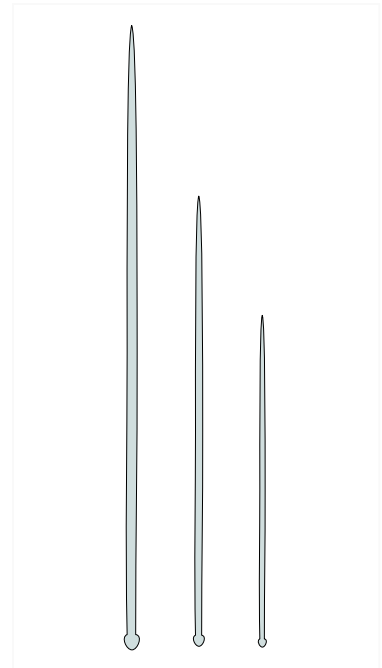

Sources G. Ackers, P. Dyrinda (J. Mallinson, K. Collins). Editor D. Moss, B.E. Picton. Draft 1 3/90

### ***Prosuberites epiphytum* (Lamarck, 1816: 398)**

Family	SUBERITIDAE
Synonyms	<i>Alcyonium epiphytum</i> Lamarck, 1816, <i>Suberites epiphytum</i> (Lamarck, 1816) Ridley 1884: 465.
Form	Very thin sheets (less than 1mm?)
Photograph	Rathlin Island (B. E. Picton)
Colour	Brown or yellow.
Smell	None?
Slime	None?
Consistency	Compact.
Surface	Even, smooth, slightly hispid. Subsurface canal patterns visible in some specimens.
Apertures	Not apparent if canal patterns absent.
Contraction	Slight, accompanied by closure of canals.

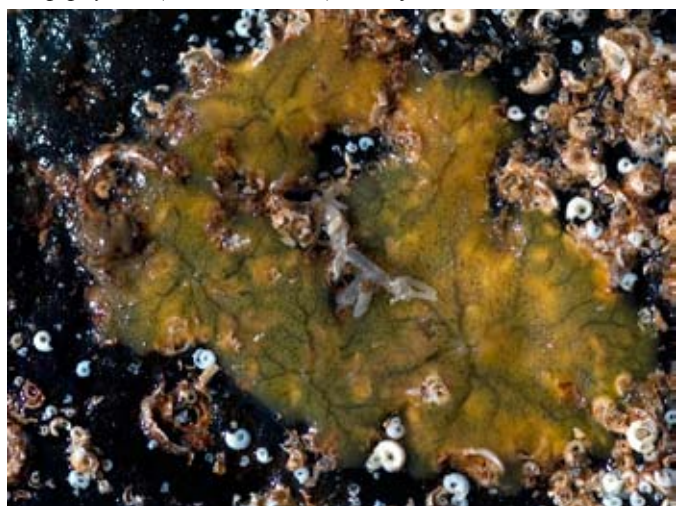

Skeleton	In very thin specimens, the skeleton consists of tylostyles arranged perpendicularly to the substrate, with the heads nearer to the substrate and sometimes touching it. In thicker specimens the basal spicules are overlain by spicule bundles that anastomize and may run either perpendicular or parallel to the substrate. At the surface the spicule bundles usually support projecting tufts of spicules (causing the hispid appearance), but tangential spicules may also be present in the dermal membrane.
Spicules	The megascleres are tylostyles (a,b), usually from about 110-(145)-180 x 4µm and 220-(300)-350 x 7µm in a given specimen. However, lengths to ca. 600µm and widths to ca. 11µm may occur in some specimens. There is no consistent relation between length and width (width is measured just beneath the head). The shafts are usually curved. The curvature occurs about one quarter to one third the length of the shaft from the head and is sometimes pronounced. The shaft tapers gradually to a sharp point in the distal half to one third of its length. The greatest thickness is just above the head. The head is smooth and shaped like an old-fashioned door handle, weakly mucronate spicules being rare. Thinner spicules often exhibit a smaller additional swelling immediately adjacent to the head. Microscleres are absent.
Voucher	BELUM : Mc856. Menai straits, Wales.
Habitat	On undersides of boulders, shells, other animals and algae. Specimens tend to be small and cryptic. Shore to ca. 12 m.
Distribution	Recently known from Anglesey (Church Island, Menai Straits), Plymouth, Roscoff.
Identify	A microscopic examination is essential. A combination of spicules orientated perpendicularly to the substrate, door-handle like heads and the other spicule characteristics described above can confirm identity. Reliable field identification characteristics are not yet known.
References	Arndt, 1935, p.43. Topsent, 1900, p.179.
Sources	G. Ackers, W.C. Jones, B. Picton.
Editor	D. Moss, B.E. Picton. <span style="float: right;">Draft 1 3/90</span>

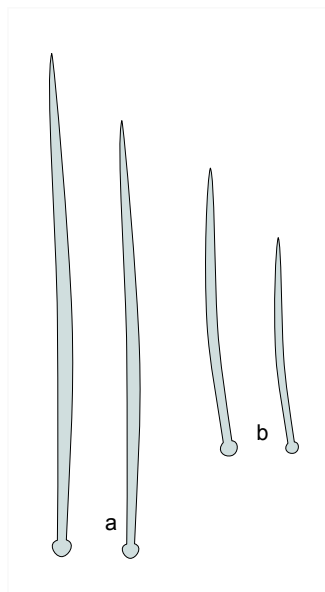

### ***Pseudosuberites sulphureus* (Bean in Bowerbank, 1866: 208)**

Family	SUBERITIDAE
Synonyms	<i>Hymeniacion sulphurea</i> Bowerbank, 1866, <i>Suberites sulphurea</i> (Bowerbank, 1866) Gray, 1867: 523.
Form	Thin sheets, but can exceed 5mm in thickness. Forms extensive irregular patches, to at least 30cm across.
Photographs	Mc33. Valentia Is., Kerry.
Colour	A bright, deep, sulphurous orange or bright yellow. The brightness is distinctive under water.
Smell	None?
Consistency	Compact, fleshy.
Surface	Even, smooth, with subsurface cavities visible through the pellucid ectosome, which is readily detachable.
Apertures	According to Topsent, 0.2 to 1mm in diameter and flush with the surface. ? not visible on collection ?
Contraction	Too thin to determine.
Skeleton	The ectosome consists of megascleres of varying size lying tangentially to the surface in bundles that intercross to form a network visible to the naked eye. The choanosomal skeleton is essentially halichondroid, with megascleres orientated in all directions, sometimes in bundles.



**Spicules** The megascleres are tylostyles in the size range 150-400µm (or more) by 3-7µm. Considerable variation in spicule size occurs in a given specimen. There is no clear division into 2 size classes as found in other suberitid species. Most of the tylostyles are straight, but when curved, the curvature occurs about a third (or less) of the way along the shaft. The shafts tend not to be parallel sided, their widest point being about midway. The tyles vary from being smoothly rounded to sharply mucronate.

There are no microscleres.

**Voucher** BELUM : Mc33. Valentia Is., Kerry.

**Habitat** Bedrock, boulders, shells. Possibly confined to areas of strong water movement. In tidal rapids on shore, beneath boulders. In sublittoral also on exposed vertical bedrock.

**Distribution** Shetlands, Scarborough, South coast of UK, Guernsey, Roscoff. Frequent on vertical rock faces at Valentia Island, Co. Kerry, Ireland.

**Identity** The tangentially arranged tylostyles in the ectosome are characteristic. A microscopic examination is essential to separate this yellow or orange encrusting sponge both from other species of suberitids, and from other taxa. It is possible that the brightness of the colour is a useful field characteristic, but more evidence is needed to confirm this.

**References** Arndt, 1935, p.42.  
Topsent, 1900, p.165.

**Source** G. Ackers, W.C. Jones, B. Picton.

**Editor** D. Moss, B.E. Picton

Draft 1 3/90

### ***Terpios gelatinosa* (Bowerbank, 1866)**

**Family** SUBERITIDAE

**Synonyms** *Terpios fugax* Duchassaing & Michelotti, 1864 is now considered to be a distinct species, *Hymedesmia tenuicula* Bowerbank, 1882:68.

**Form** Small, thin sheets.

**Photographs** Marseille, France. (B.E. Picton)

**Colour** Basically ochraceous yellow or light brown due to pigment present in the choanocytes. Commonly the colour is transformed into a deep blue, (or a dull green or a bright orange yellow,) by the presence of symbiotic algae, at least in the superficial parts of the sponge. The blue or orange yellow colour persists in alcohol and in dried specimens.

**Smell** None reported.

**Consistency** Sponge is generally fairly soft.

**Surface** Surface smooth, very occasionally minutely hispid.

**Apertures** Oscules are minute - not distinct to the naked eye.

**Contraction** Not obvious.

**Skeleton** The skeleton is confused rather than subradial and the megascleres are not clearly divided into two size groups. There is a somewhat disorderly and loose arrangement

of tylostyles, of which a few are usually directed vertically upwards. The tylostyles may be single, or united in places to form bundles or brushes which cross one another in all directions. The tylostyles in the bundles

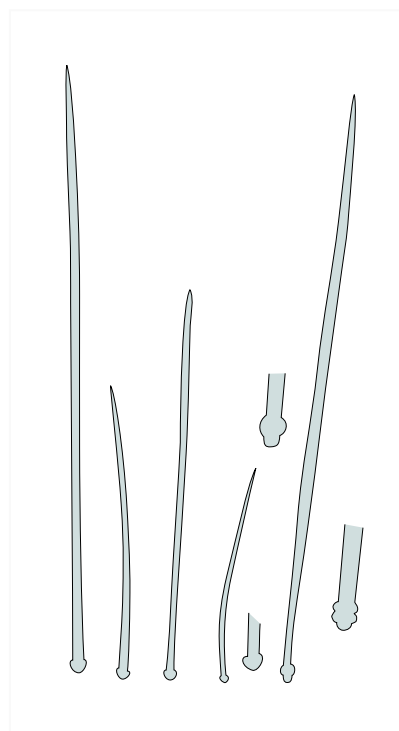

all point in the same direction, the heads and points tending to occur side by side. The spicules may be sparse or crowded depending on the individual. The ectosome does not have a tangential skeleton.

**Spicules** The tylostyles “(ca. 250-400µm)” have a well-developed head with a rounded apex, often with a ring-swelling around the middle or base. The head may also appear heart-shaped in optical section, i.e. wide at the base next to the shaft and narrower, but rounded, at the apex. The smooth shaft may be straight, but usually curves gradually along its length. Sometimes there is a more pronounced curvature at about 1/3 to 1/4 of the length from the head. The shaft becomes thinner distally, ending in an acute point.

**Voucher** MNHN Paris : D-T-2476.

**Habitat** On rocky surfaces and the undersides of boulders. In the Mediterranean it occurs on algae and other sponges. It has been recorded as “on bryozoans and corals.”. It is found both littorally, at low water spring tide levels, and sublittorally to 68m. The bright orange-yellow form (if this is really the same species!) only occurs sublittorally.

**Distribution** Atlantic, North Sea and Channel coasts of Europe; Mediterranean, etc.

**Identity** The deep blue variety is one of the few examples of a blue British sponge (see also *Hymedesmia paupertas*, this Guide). The spicule arrangement and tylostyles are characteristic and can be seen under the microscope.

**References** Arndt, 1935, p.42.  
Topsent, 1900, pp.193-203.

**Sources** W. Clifford Jones, S.M. Stone.

Editors D. Moss, B.E. Picton.

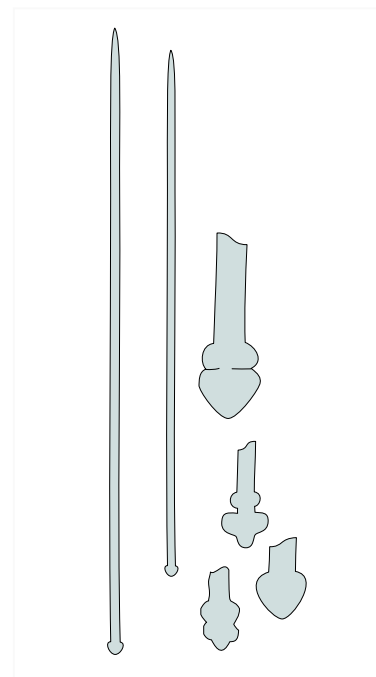

## ***Homaxinella subdola* (Bowerbank, 1866:247)**

**Family** AXINELLIDAE

**Synonyms** *Pachaxinella subdola* Burton, 1930:504.

**Form** Irregularly branching-erect. The branches sometimes coalesce but never produce the lamellate forms found in other Axinellid sponges. The side branches tend to arise at right angles to the main stem, which gives it an untidy, ‘bushy’, appearance. The branches are circular in cross-section, borne on a thinner, wiry stalk. Up to 15cm high.

**Photographs** 1. St. Mary’s, Scilly Isles. (B.E. Picton)

2. Skomer Is, south Wales. (B.E. Picton)

**Colour** Pale yellow, deep orange, orange, brownish-yellow or golden-yellow when alive; becomes creamy white in alcohol.

**Smell** None or slight?

**Consistency** The branches are firm, tough and elastic but collapse if compressed when alive. The stalk is wiry.

**Surface** Even, slippery, smooth; in older specimens minutely hispid.

**Apertures** The oscules are small, not numerous, and disposed irregularly on the branches. They become inconspicuous on collection.

**Contraction** Considerable lateral contraction of the branches occurs on collection. This is in contrast to the other Axinellids, which do not contract markedly in this manner.

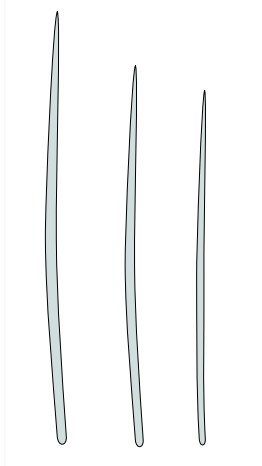

Skeleton	A plumose axial core of loose fibres of long styles, which are surrounded by a dense sub-surface layer of irregularly arranged spicules. Some of these lie at right angles to the surface (occasionally piercing it); others are tangential to it. The intervening space between the two main skeletal areas is occasionally bridged by thin, almost imperceptible, fibres of spicules. Small amounts of spongin are present.	
Spicules	The megascleres are smooth, usually straight, styles, which vary in size from 270-(440)-560 x 5µm. There are no microscleres.	
Voucher	BELUM : Mc481. Skomer Island.	
Habitat	Found in sheltered and semi-exposed conditions. On horizontal and slightly inclined rock, covered with a layer of silt. Out in the open on sheltered bottom plains, or at the bottom of gullies, which create relatively sheltered conditions in otherwise exposed situations. Circalittoral (?): at Lundy at 10m or deeper. <i>Raspailia hispida</i> , <i>Raspailia ramosa</i> and <i>Axinella dissimilis</i> are other branching species often seen in the vicinity.	
Distribution	"British Isles". Also reported from "Sea of Japan; Sea of Okhotsk" In the UK this is a southern species; recently recorded from the Scilly Isles; Lundy; Devon; and Skomer. The type locality is Guernsey.	
Identity	Alive the appearance lies between that of <i>Axinella dissimilis</i> and <i>Haliclona oculata</i> . However the oscules of <i>Homaxinella subdola</i> are less distinctive and not arranged in rows. In the field the best identifying character is probably the wiry stalk, which can be felt if not seen among the underlying 'turf'. The untidy appearance of the sub-branching, caused by the secondary growth of short, stubby branchlets, may also prove to be a useful character, but this needs testing. The side branches come off more or less at right angles - a very characteristic feature. There is a slight possibility of confusion with <i>Adreus fascicularis</i> (q.v.) which is much more wiry and on average a smaller sponge which does not branch 'untidily' as does <i>Homaxinella subdola</i> . <i>Adreus fascicularis</i> also has distinctive lines/grooves running along the branches.	
References	Bowerbank, 1866, p.247; 1874, p.106. Burton, 1930, p.504. Hiscock, Stone and George, 1983[1984], p.23.	
Sources	S.M. Stone, G. Ackers, B.E. Picton.	Editors D. Moss, B.E. Picton.

### ***Polymastia boletiformis* (Lamarck, 1815:332)**

Family	POLYMASTIIDAE		
Synonyms	<i>Polymastia robusta</i> Bowerbank, 1862:751; Bowerbank, 1866:62.		
Form	Massive - globose. A thick, bulbous sponge, with the upper surface covered by vertical, tapering, contractile papillae. The hollow papillae are approximately the same length, but vary in number from individual to individual. Typically the papillae are simple, but occasionally two adjacent papillae fuse along their length, resulting in figure '8'-like oscular openings (more rarely, three papillae may fuse). The sponge is firmly attached by a broad base.		
Photographs	Calve Is. Mull, west Scotland. (B.E. Picton)		
Colour	Varying shades of orange or yellow, depending on density. The body and papillae are similar.		
Slime, Smell	None.		
Consistency	The body is soft; the papillae are firm but flexible.		
Surface	Clean, smooth and slightly velvety. The surfaces of the body and the papillae are similar.		

Apertures	The oscules and pores are carried on conical papillae. There are usually a few papillae with terminal oscules gaping wide open. Pores cover the surface of the papillae and are visible <i>in situ</i> , but become invisible on collection.
Contraction	The body contracts slightly when collected and preserved. The papillae are contractile, and may reduce to small button-like bumps over the surface of the body. Rarely, papillae may collapse to lie fully extended over the surface, resembling floppy straps. This is a condition typical of preserved specimens, but can occur when an individual is stressed. Confirmation is needed. The oscules can be induced to close slowly when touched.
Skeleton	Radiate to sub-radiate, with the radial arrangement being most apparent near to the surface, where there is a well organised ectosome. The skeleton of the papillae is a continuation of the main body skeleton. There is a single category of spicule (tylostyle), divided into two size groups. The larger are the main structural megascleres, forming loose, multispicular tracts (10-12 spicules thick), which wander up through the body and on into the papillae, but do not pierce the surface. Loose spicules lie scattered between the tracts. Megascleres of the same size form a tangential layer of inter-crossing spicules, just below the surface (2 - 4 spicules thick), which supports a single layer of smaller tylostyles. These are arranged perpendicular to the surface, grouped into plumose brushes, but becoming more tightly packed in mature sponges to form a palisade. The inhalent and exhalent canal systems fill the centres of the papillae, supported by the multispicular tracts. At the surface of the papillae, the ectosomal skeleton is exactly as that of the body.
Spicules	The megascleres are tylostyles of two size groups: the spicules of the tracts (a,b) and tangential layer are 500-(590)-700µm, stout, fusiform, with swellings at or just above the head; the spicules of the surface brushes (c) are 125-(166)-190µm in length, curved, parallel-sided, with virtually no swelling at the head. There are no microscleres.
Voucher	BELUM : Mc214. Strangford Lough, Down.
Habitat	Most commonly found on sediment covered, upward facing, rock or boulder tops in the lower infralittoral and circalittoral zones, associated with a bryozoan/hydroid 'turf'. Found in conditions varying from quite rapidly flowing water to those in which silt falls out of suspension. "From tidal pools to 2300m".
Distribution	"Arctic; Atlantic coasts of Europe and N. America; never found in the Mediterranean."(?) Recently known from St. Abbs; many sites on the western and southern coasts of the British Isles.
Identity	The other common, papillate sponges in British waters which might be confused with <i>Polymastia boletiformis</i> by appearance are <i>Ciocalypta penicillus</i> (q.v.) and <i>Polymastia penicillus</i> (q.v.). Apart from other differences, <i>Polymastia boletiformis</i> sits proud on the rock surface, whereas <i>Polymastia mamillaris</i> often occupies small, shallow hollows.

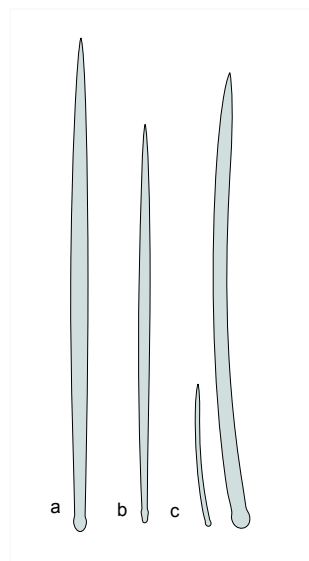

***Polymastia boletiformis***

***Polymastia penicillus***

*Polymastia boletiformis* is one of the most commonly seen sponges on rock below the kelp in the west and



s o u t h

west of the British Isles. Several other, less conspicuous, *Polymastia* species are known to occur around the British Isles, but are more likely to be confused with *Polymastia penicillus*.

- References
- Arndt, 1935, p. 34.  
 Boury-Esnault, 1974, pp.141, 152.  
 Cabioch, 1968, p.215.  
 Hiscock, Stone and George, 1983 [1984], p.21  
 Topsent, 1900, p.147.

Sources S.M.Stone, (J.D. Guiterman, D.Moss, B. E. Picton). Editors J.D. Guiterman, D.Moss, B.E. Picton.

***Polymastia penicillus* (Montagu, 1818)**

Family POLYMASTIIDAE

Synonyms *Polymastia mamillaris* Johnston, 1845 and Bowerbank, 1864 not *Polymastia mamillaris* Müller, 1806. N.B. *Polymastia mammeata* (Bowerbank 1866:170) appears to be a form of *Hymeniacidon perleve* (Montagu).

Form A low, spreading cushion (up to 1cm thick), with stiffly erect, semi-contractile papillae projecting above the sediment covered body. The hollow papillae are variable in number, and their length varies with age, condition and situation of the individual sponge, so that no two individuals ever look quite the same. The papillae show little tendency to fuse (contrast *Polymastia boletiformis*). The sponge is firmly attached to rock beneath the sediment.

Photographs Rublia Bhrengadal, St. Kilda. (B.E. Picton)

Colour The body is dirty grey, or orange yellow in cleaner water conditions. The papillae are creamy-white to pale yellow.

Slime None.

Consistency The body is hard, and the papillae stiff.

Surface That of the body is hispid, roughened by projecting spicules which trap sediment particles, ranging from mud to fine gravel.

On a few occasions, when the surface is clear of sediment, the sponge may be seen enveloped in algae or bryozoans, etc. The papillae are smooth and clean; often a fine network of spicules can be seen on the surface.

Apertures The oscules and pores are carried on the cylindrical, slightly tapering, papillae. The exhalent papillae are large, few in number and, with the terminal oscules usually open, can be distinguished easily from the thinner inhalent papillae. The pores are located towards the upper ends of the papillae, but are not obvious.

Contraction The body shows no contraction. The papillae are only semi-contractile and spring upright when pushed down flat. (? are these ever found to contract completely down as in *Polymastia boletiformis*? Can the oscules be induced to close when touched?)

Skeleton Radiate, with a well-organised ectosome. The skeleton of the papillae is continuous with that of the main body. There is one category of spicule (tylostyles), divided into three size groups. The larger (a) constitute the main structural megascleres, forming stout, multispicular tracts (up to about 15 spicules thick), which run up through the body and on into the papillae, partially piercing the surface. Loose spicules lie scattered between the tracts. The middle-sized tylostyles (b) form a tangential layer of inter-crossing spicules just below the surface (2 - 4 spicules deep), supporting a single layer of the smallest megascleres (c) which are arranged perpendicular to the surface, grouped into brushes. In mature sponges these spicules become more tightly packed, forming a palisade. The multi-spicular tracts give support to the walls of the papillae, with a similar ectosomal arrangement to that found in the body.

Spicules The megascleres are (tylo)styles of three sizes. The spicules of the tracts (a) are 950-(1070)-1200µm, straight and fusiform, with virtually no swelling at the heads. Those of the tangential layer (b) are 250-(500)-725µm, usually with a slight swelling near the head end. The spicules of the surface brushes (c) are 115µm-(140)-175µm long, curved, fusiform, with ovoid tyles at the head. There are no microscleres.

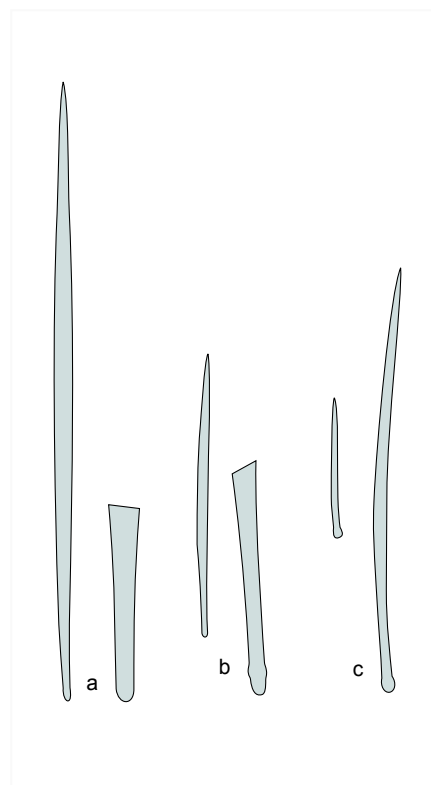



Voucher	BELUM : Mc1310. Maidens, Antrim.	
Habitat	This species is usually found on upward facing rock (rarely on boulder tops), or at the sediment/bedrock interface with the body beneath a layer of sediment. Never found out in the open on bottom plains as <i>Polymastia boletiformis</i> . Prefers conditions where some silt is held in suspension by flowing water? Confirmation of these features is needed. Its preference for silty conditions makes it more easily overlooked than <i>Polymastia boletiformis</i> . "Littoral to 2300m."	
Distribution	"Arctic; Atlantic coasts of Europe and N. America; Mediterranean." Recently known from many sites on the western and southern coasts of the British Isles.	
Identity	There are several papillate species with which <i>Polymastia penicillus</i> and <i>Polymastia boletiformis</i> could be confused; the recent revision of this Genus by Boury-Esnault, (1987) should be consulted for descriptions of other species (including Bowerbank's other <i>Polymastia</i> spp.). BEP believes several other species, some probably undescribed, to be not uncommon in some localities; they may easily be confused with <i>Polymastia penicillus</i> .	
References	Arndt, 1935, p.33 Boury - Esnault, 1974, pp. 141, 146. Boury - Esnault, 1987. Cabioch, 1968, p.215. Hiscock, Stone and George, 1983 [1984], p.21. Topsent, 1900, p. 131.	
Source	S.M. Stone, B. E. Picton.	Editors D.Moss, B.E. Picton.

### ***Cliona celata* Grant 1826:78**

Family	CLIONAIDAE (=THOOSIDAE )	
Synonyms	<i>Vioa celata</i> (Grant, 1826:78) Schmidt, 1866:20), <i>Raphyrus griffithsii</i> Bowerbank 1866:354.	
Form	One of the few boring species which produces a massive or 'raphyrus' stage (the only British species?). In the raphyrus stage the sponge becomes massive-lobose with rounded ridges up to 40cm across. It often forms a thick plate-like structure standing on its edge and up to 100 cm long. In the boring stage it is seen as clear sulphur-lemon lobes, which are the rounded tips of papillae, and are found studding limestone rock, shells, etc.	
Photographs	<ol style="list-style-type: none"> <li>1. Keem Bay, Achill Island, Mayo. (B.E. Picton)</li> <li>2. Ringhaddy sound, Strangford Lough, Down. Boring phase. (B.E. Picton)</li> </ol>	
Colour	Raphyrus form: yellow, becomes darker out of water, and in alcohol goes brown discolouring both the alcohol and the specimen labels. Sometimes observed with red discolouration surrounding oscular openings (symbiotic algae?)	
Smell	None.	
Consistency	Firm with tough outer layer. "Compact."	
Surface	The massive form is evenly covered by rather tuberculate retractable inhalent papillae. The surface between these papillae is more or less smooth.	
Apertures	In the massive form large oscules with raised rims are found along the tops of ridges. Delicate, thin walled, retractable inhalent papillae, which project up to 1cm above the surface when extended, cover the remainder of the surface. These are not noticeable when out of the water as they close and retract below the surface. In the boring stage apertures are at the tips of the papillae.	
Contraction	The whole sponge shows a noticeable decrease in size when removed from the water. The papillae, and to a lesser extent the oscules, contract to such an extent that they become almost invisible out of the water.	
Skeleton	Confused, showing no differentiation into ectosomal and internal skeletons.	

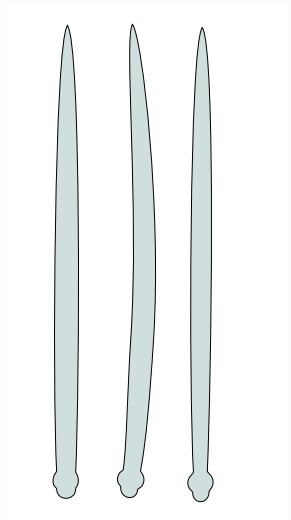

Spicules	Megascleres are tylostyles 280-(350)-430µm densely and irregularly arranged. The heads have swellings just up from the tip in most spicules. Microscleres, are apparently normally absent; if present (this may indicate a related species), they are modified microrhabds (spiraster or amphiaser types derived from sanidasters).	
Voucher	BELUM : Mc174. Strangford Lough, Down.	
Habitat	On rock. Begins life by boring into limestone, shells or calcareous red algae. Can withstand sediment.	
Distribution	Widely distributed. "Eastern Atlantic from Sweden to Gibraltar and Mediterranean." The massive form is very common in parts of SW Britain, sometimes dominating the underwater 'scenery'. This form apparently reaches its easterly limit around Dorset in the Channel; apparently not found on North Sea coasts of British Isles?	
Identity	By sight alone if massive form, the colour and inhalent sieve-like openings are distinctive. The boring form can be identified to genus only, but cannot be confused with any other genus except for <i>Thoosa</i> and <i>Alectona</i> , occasionally found in British waters.	
References	Arndt, 1935, p.44. Hartman, 1958a, pp.16, 87, 106. Hiscock, Stone and George, 1983[1984], p.21. Topsent, 1900, p.32.	
Source	J.D. Guiterman, S.M. Stone, B. E. Picton.	
Editors	J.D. Guiterman, D. Moss, B.E. Picton.	

### ***Stelligera rigida* (Montagu, 1818:87)**

Family	HEMIASTERELLIDAE	
Synonyms	<i>Vibulinus rigidus</i> (Montagu, 1818:87) Topsent, 1890:202.	
Form	Branching erect to sub-lamellate ('palm-like') with the branches webbed together along their length. Up to 5cm high. The terminal branches are typically 5mm in diameter, tending to be bulbous at their extremities in smaller specimens. The stalk is relatively short and thick.	
Photographs		
Colour	Pale yellow to "orange". Usually there is adhering detritus which has to be brushed aside to see the features.	
Smell	None.	
Slime	Some.	
Consistency	Firm. The strong axial skeleton gives a firm axial consistency. The peripheral tissue is soft and easily rubbed off but less so than <i>Stelligera stuposa</i> (q.v.).	
Surface	Strongly villose (very 'bristly') with long projecting spicules (to 2mm), which often trap quantities of silt.	

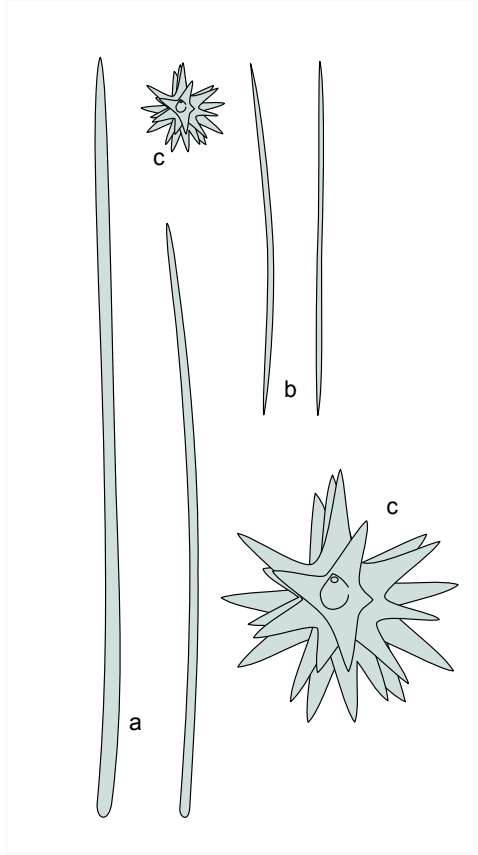
Apertures	The oscules are small and inconspicuous, on the tops of branches. <i>In situ</i> they are apparent as ‘clear’ areas in the layer of silt. The oscules are not apparent when the sponge is preserved.	
Contraction	None.	
Skeleton	Plumose. An axial skeleton of longitudinally orientated megascleres forms a stiff core along the centre of each branch. There is a softer, extra-axial skeleton of often single, long megascleres which radiate out at right angles from the core and project through the surface. Slender megascleres scattered in the choanosomal skeleton also form divergent brushes around the projecting spicules at the surface. The microscleres (euasters) form a layer at the surface. There is a minimal amount of spongin.	
Spicules	The megascleres of the axial core are styles (a) “to 3mm”, 500-(530)-550 $\mu$ m & 890-(1550)-2150 $\mu$ m long and, occasionally, strongyles 775-(880)-1075 $\mu$ m. In the extra-axial skeleton long styles are found, with slender oxea (b) to about 460-(600)-780 $\mu$ m in the divergent brushes. The microscleres are euasters (c) (ca. 22 $\mu$ m diameter). Compared with <i>Stelligera stuposa</i> (q.v.) these asters have fewer rays, which are more robust and conical in shape.	
Voucher	BELUM : Mc975. Carlingford Lough, Down.	
Habitat	Usually in somewhat sheltered locations with some current. Found in Strangford Lough on sides of boulders with a 2 knot current.	
Distribution	“British Isles; Channel coast of France.” Known recently from Strangford Lough; Burtonport, Donegal; Anglesey; Skomer; Lundy; Sussex; west coast of Scotland. A fairly common species.	
Identity	More robust than <i>Stelligera stuposa</i> with larger spicule categories. Some authorities consider these species to be synonymous. The form may be similar to that of <i>Axinella damicornis</i> (q.v.), but the colour, robust bristles and sliminess are characteristic.	
References	Arndt, 1935, p. 86. Descatoire, 1969, p.18. Hiscock, Stone and George, 1983[1984], p.23. Topsent, 1890, p. 292.	
Sources	B.E. Picton, S.M. Stone, (G. Ackers, D. Moss).      Editors D. Moss, B.E. Picton.	

### ***Stelligera stuposa* (Ellis & Solander, 1786:186)**

Family	HEMIASTERELLIDAE
Synonyms	<i>Dictyocylindrus stuposus</i> (Ellis & Solander, 1786:186) Bowerbank, 1866:116, <i>Vibulinus stuposus</i> (Ellis & Solander, 1786:186) Gray 1867:545.
Form	Branching - erect, branches often flattened in cross section; rarely fused. The branching is dichotomous or, more frequently, polytomous, usually more or less in one plane. Stalked; up to 10 cm, or more, high.
Photographs	Hope Cove, south Devon. (B.E. Picton)
Colour	Yellow, orange, red-brown.
Smell	None.
Slime	Exudes quantities of slime when taken out of the water.
Consistency	Moderately firm, but with a soft outer layer which is easily rubbed off. “Elastic.”
Surface	Villose, hairs of uneven length (cf. <i>Raspailia hispida</i> ). The hairs trap particulate matter; the particles are easily seen with the unaided eye.
Apertures	Small oscules in groups near the tips of branches. The position of these oscules may help identification underwater. Not visible in dead material.

**Skeleton** Plumose. An axial skeleton of longitudinally orientated megascleres forms a stiff core along the centre of each branch. A softer, extra-axial, skeleton of long megascleres (often single) radiates at right angles away from the core and penetrates the surface. Slender megascleres are scattered through the internal skeleton and also form divergent brushes around spicules projecting through the surface. Microscleres form a layer at the surface. Minimal amounts of spongin are present.



**Spicules** Megascleres of the axial core are styles (a), occasionally strongyles (b). Those of the extra-axial skeleton are long styles (c), and the divergent brushes consist of slender oxea or anisoxea (d). The microscleres are euasters (e) (ca. 14µm diameter). Styles 900-(910)-1000µm “to 2000µm” in length, strongyles 630-(760)-880µm, oxea 520-(610)-690µm.

**Associations** Nematode worms often live in the outer, silt-covered, layers of the sponge.

**Voucher** BELUM : Mc814. Strangford Lough, Down.

**Habitat** On rocks and stones and in rock crevices. Not found in harbours. Common.

**Distribution** “Britain; France; Spain; Mediterranean.” A common species in the circalittoral in the British Isles, at least on the west coasts.

**Identity** Production of slime in a hairy, branched sponge whose branches are somewhat flattened in cross section is probably indicative of *Stelligera stuposa*. To be certain a microscopic check is essential. The species with which *Stelligera stuposa* is most frequently confused is *Raspailia hispida* (q.v. and table below), especially in the size range up to 15 cm. *Raspailia hispida* and *Stelligera stuposa* may be separated by eye underwater using the information in the following table. The characters used to separate the two species need to be checked to see if they are reliable. Guide users are asked to report their experience of using the table, so that unreliable characters can be discarded in future editions of the Guide.

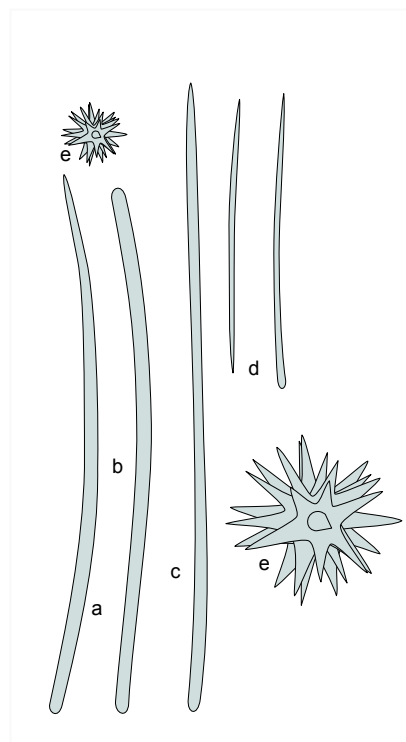

Other yellow, branched sponges with which it can be confused, especially underwater, are as follows:

*Axinella dissimilis* (q.v.). Surface, stellate, grooves converge on the oscules (only easily visible out of the water). Altogether a much larger and fleshier sponge than *Stelligera stuposa*.

*Haliclona oculata* (q.v.). Not hairy, with neat oscules arranged serially along the edges of the branches.

*Endectyon spp.* (q.v.). Smaller, more delicate looking, with a brighter, yellow or red-brown, colour.

	<i>Stelligera stiposa</i>	<i>Raspailia hispida</i> (ochre form)
<b>Branching</b>	Polytomous or can be dichotomous.	Dichotomous or can be polytomous.
<b>Branch shape</b>	Usually oval in cross-section.	Usually circular in cross-section.
<b>Surface</b>	Unevenly bristly, large pieces of particulate matter accumulate. Rugose (always?)	Evenly bristly, small pieces of particulate matter accumulate. Not rugose.
<b>Colony shape</b>	Branching more or less in one plane. Can become arborescent.	Branching usually in one plane. A more elegant looking sponge.
<b>Oscules</b>	In scattered groups at tips of branches.	In neat rows along the sides of branches.
<b>Slime</b>	Exudes considerable quantities of slime when removed from the water. (? most noticeable in dead specimens - really fresh material may produce little or no slime?)	No mucus.

Presence or absence of slime may prove to be the only reliable field character for separating these two species. Unless one is familiar with a local population, and maybe even then, it is necessary to check the spiculation to be certain of identification. It is surprising how often one can be caught out by these two species!

References Arndt, 1935, p.86.  
Descatoire, 1969, p.18.  
Hiscock, Stone and George, 1983 [1984], p.24.

Sources S.M. Stone, B.E. Picton. Editors D. Moss, B.E. Picton.

---

### ***Paratimea constellata* (Topsent, 1893)**

Family HEMIASTERELLIDAE

Synonyms *Bubaris constellata*, *Halicnemia constellata*.

Form Encrusting in thin irregular patches.

Photographs Lough Hyne, Cork. (B.E. Picton)

Colour Pale yellow. Often there is adhering detritus due to the long projecting spicule brushes.

Smell None.

Slime None.

Consistency Thinly encrusting but fairly tough, not inclined to crumble when scraped off.

Surface Strongly villose (very 'bristly') with long projecting spicules (to 2mm), which often trap quantities of silt.

Apertures The oscules are small and inconspicuous, but there are excurrent channels which are just visible on close inspection of living colonies *in situ*.

Contraction None apparent.

Skeleton Irregular. Long tylostyles stand perpendicular to the substratum, with their heads embedded in a basal spongin layer, and their shafts protruding from the surface. Smaller tylostyles lie jumbled sparsely in the interior. Slender megascleres form divergent brushes around the projecting spicules at the surface. The microscleres (euasters) form a conspicuous layer at the surface.

Spicules The largest megascleres are tylostyles (a) 1500-2700µm long. The surface brushes consist of slender oxea or anisoxea (b) 440-1140µm, often with a slight central swelling or tyle. The microscleres are euasters (c) 21-45µm diameter. Compared with *Stelligera spp.* these asters have fewer rays, and are more irregular in shape.



Voucher	BELUM : Mc1707. Lough Hyne, Cork.
Habitat	Usually in deep water, (25m+) both in sheltered locations and in exposed sites. Found in Lough Hyne on vertical rockfaces with heavy siltation.
Distribution	Recorded from the channel coast of France, the Mediterranean sea and the Azores. Recent records from Lough Hyne, Cork, where it is quite common on vertical rockfaces, and from vertical rock on the Dingle peninsula, Co. Kerry, and St. John's Point, Co. Donegal. Probably more common than records suggest.
Identity	The external appearance, of an irregular thin yellow encrustation, is not very distinctive. The spiculation, including surface brushes and euasters, is very distinctive. <i>Timea</i> species also have euasters, but no surface brushes of oxea.
References	Topsent, E., (1897), p245. Boury-Esnault, N., & Lopes, M.T. (1985), p168.
Sources	B.E. Picton.
Editor	B.E. Picton.

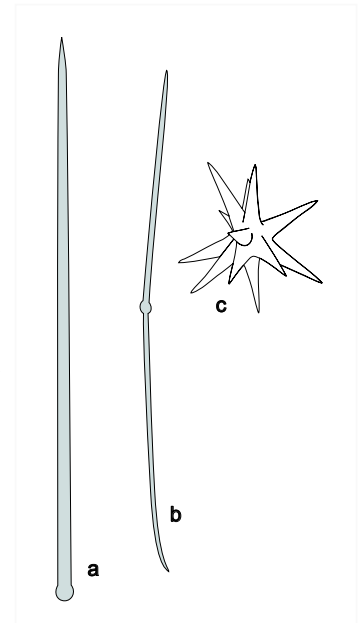

### *Adreus fascicularis* (Bowerbank, 1866, p.110)

Family	HEMIASTERELLIDAE
Synonym	<i>Dictyocylindrus fascicularis</i> Bwk, 1866:110
Form	Branching-erect, stalked. Branches are slender, circular in cross section, tapering to a point, and coalesce where they touch. The branching tends to be dichotomous, in one plane, and can produce an antler-like appearance. Several 'individuals' can arise from one flat, spreading base, which may be buried in the substrate - reports on this phenomenon are welcome. Grows up to 15 cm (?) high.
Photograph	Noire Pute, Herm, Channel Isles. (B.E. Picton)
Colour	Strong yellow/brown/ochre/greenish/orange to brownish-yellow.
Smell	None.
Slime	A light covering of silt may be found adhering to a little mucus - there are no spicules to trap it.
Consistency	Firm, rigid, wiry - ruptures through to the axial skeleton when bent through 90 degrees, but does not 'snap'.
Surface	Even, slippery, smooth. There are irregularly positioned, faint, longitudinal striations just below the surface, visible after preservation, which are characteristic.
Apertures	Oscules are not apparent.
Contraction	None.
Skeleton	Plumose. An axial skeleton of longitudinally orientated megascleres forms a stiff core along the centre of the branches, which is surrounded by fibres radiating at right angles out to the surface, but not piercing it. Minimal amounts of spongin are present (?).
Spicules	Megascleres are styles (a), 270-(440)-560 x 4-5µm; microscleres are euasters (b) (small oxyasters), ca. 8µm diameter.
Voucher	BELUM : Mc659. Lundy Is., Bristol Channel.



Habitat	Half buried in sediment overlaying horizontal bedrock, also on vertical rock faces; tolerant of silt. Found in sites with strong tidal streams and mobile shelly gravel, usually deeper than about 12m (but in Jersey low growing specimens are common in the lower infralittoral, in direct competition with foliaceous algae).		
Distribution	“English Channel; Spain.” Recently known from Lundy (occasional); S. Devon (rare); Channel Isles (occasional). A southern species in the British Isles.		
Identity	The manner of branching and the longitudinal striations are quite characteristic, enabling this rather rare species to be recognised on first sight.		
Reference	Hiscock, Stone and George, 1983[1984], p.23.		
Source	S.M. Stone, G. Ackers.	Editors	D. Moss, B.E. Picton.

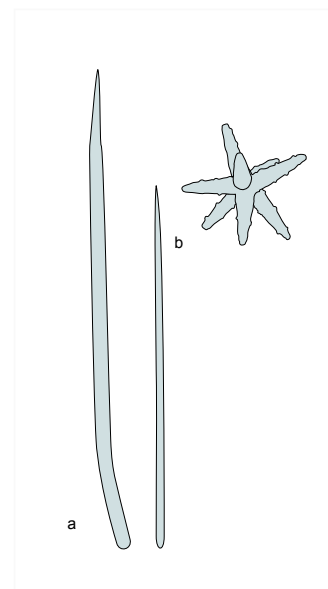

### *Halicnemia patera* Bowerbank, 1862

Family	HETEROXYIDAE
Synonyms	<i>Crella inflata</i> (Bowerbank) of Arndt, 1935.
Form	A thin crust (to 2mm thickness) forming discrete rounded patches on rock surfaces.
Colour	Pale orange-pink, yellow, ochre.
Smell	None.
Slim	Considerable quantities of slime are released from the sponge on removal from water.
Consistency	Tough, fibrous.
Surface	Conulose with tissue supported on bundles of long spicules which lie at an angle to the surface, facing the same direction and giving a swept appearance.
Apertures	Oscules are small and inconspicuous, not raised above the surface.



Contraction	None noticeable, but collected specimens have a tendency to curl.
Skeleton	A basal layer of large scattered tylostyles lie at an angle to the substratum with their swollen heads lying in contact with the substratum. Long thin centrotylote oxea form dense bundles which ascend at an angle through the sponge to the surface. The entire sponge is filled with a dense mass of small acanthoxea.
Spicules	The large tylostyles (c) measure up to 2mm but are normally broken during preparation. The centrotylote oxea (b) form dense bundles. Acanthoxea (a) have a characteristic sharp bend in the middle of their length.
Habitat	Originally described from deep water as totally enclosing pebbles or stones. Recent observations of this species in shallow water have been from steep rockfaces with considerable amounts of silt.
Distribution	Old records are from Shetland and Brittany. Recent finds have been from Roaringwater Bay and Lough Hyne in West Cork, Ireland and from Skomer Island, South Wales.

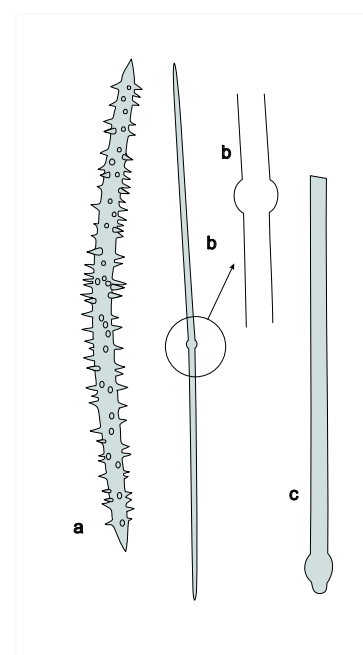

Identity	The external appearance of the surface combined with the colour makes tentative field identification possible. The spicule compliment is unusual and characteristic.
Voucher	BELUM: Mc1598. Lough Hyne, Co Cork.
Editors	B. E. Picton.

### ***Thymosia guernei* Topsent, 1896:574**

Family	CHONDROSIIDAE	
Synonyms	None in common use.	
Form	Thin sheets to low, spreading, massive-lobose forms (forming patches up to 60cm across). Firmly attached by a broad encrusting base. Overall appearance like cold mashed potato.	
Photographs	Inishmaan, Aran Is., Galway. (B.E. Picton)	
Colour	Off-white surface, pale grey-orange interior.	
Smell	Slight.	
Slime	A thin covering, which only becomes apparent when silt falls out of suspension onto the surface of the sponge, where it becomes trapped and forms mucous 'threadlets', which are then caught in the passing current and removed. It is very slippery to handle immediately after collection.	
Consistency	A solid, rubbery texture.	
Surface	Clean, smooth and undulating. Sometimes raised up into angular projections where other sedentary organisms have become engulfed (e.g. hydroids, barnacles, etc.). Often, double openings of the mud-lined burrows of the polychaete worm <i>Polydora</i> are seen at the surface.	
Apertures	A few, small oscules (1-2mm openings) are scattered singly along the tops of ridges and lobes; these are often occupied by crustaceans and brittle stars. Countless microscopic pores cover the surface except in the vicinity of the oscules. In mature sponges these pores are concentrated at the base of the deep hollows formed by the steep-sided lobes. They are difficult to see with the naked eye on the living animal, especially when the 'skin' is tightly stretched. They are more easily seen as puckered wrinkles in the hollows, when the surface is relaxed on preservation.	
Skeleton	There is no mineral skeleton. Instead it has a thick cortex which is plentifully reinforced by fibrillar collagen which serves to strengthen the otherwise soft matrix. Spongin fibres, with unusual kidney-shaped swellings, further strengthen the matrix, by running vertically through the body to the surface. These branch and anastomose at intervals and are very distinctive in sections.	
Spicules	None.	
Associations	<i>Polydora</i> seems to form a regular association with the sponge. The brittle star <i>Ophiothrix fragilis</i> also often occurs with it.	
Voucher	BELUM : Mc737. St. John's Pt, Donegal.	
Habitat	This sponge favours flowing water conditions in habitats which are semi-exposed to waves and current. It is usually found on fissured, vertical rock (gullies and cliff faces), set back in recesses, or under overhangs or inside caves. It is only occasionally found out on open rock faces, which are exposed to the full force of the moving water. Very occasionally it is found on horizontal surfaces. Littoral to ca. 30m (optimum depth range between 15 and 25m ?).	
Distribution	Considered to be rare. Recently found off a number of islands off SW Britain and western Ireland: Aran Islands, Co. Galway; Clare Island Co. Mayo; Skokholm; Lundy. Also occasionally off the mainland: N. Pembrokeshire (off Abereiddy): St. Johns Point, Co. Donegal; France (Concarneau); Portugal (Algarve).	
Identity	The irregular surface, tiny oscules and white colour in a massive sponge are quite distinctive. The identity is easily confirmed by the lack of spicules and distinctive skeletal fibres.	



Reference Hiscock, Stone and George, 1983 [1984] ,p.20.  
Sources S.M. Stone, B.E. Picton. Editors D. Moss, B.E. Picton.

## ***Raspailia hispida* (Montagu, 1818:81)**

Family RASPAILIIDAE

Synonym *Dictyocylindrus hispidus* (Montagu, 1818:81)  
Bowerbank, 1866:108; nec *Spongia hispida*  
Lamarck, 1814:452.

Form Branching erect, branch diameter about 4-6mm, and more or less circular in cross-section. Branches gradually taper to blunt tips. Branching may be very regular and dichotomous; or profusely branched (usually when found in estuarine conditions). Stalked, branches rarely fuse.

Photographs Friesland Rock, Coll, west Scotland. (B.E. Picton)

Colour Ochre, yellow/brown.

Smell None.

Slime None.

Consistency Firm, "elastic". There is a soft outer layer on a dense axial core. The outer layer is easily rubbed from the inner core.

Surface Bristly (villose), with hairs of uniform length (cf. *Stelligera stuposa*). Hairs may trap particles of silt.

Apertures The small oscules can be seen underwater, and tend to form evenly spaced rows along the edge of branches. Not apparent when preserved.

Contraction None.

Skeleton Plumoreticulate, with a dense axial condensation of reticulating spongin fibres, which are cored by subtylostyles and sparsely echinated by acanthostyles. There is a soft, extra-axial skeleton of long spicules radiating out at right angles from the core to pierce the surface. Divergent brushes of slender spicules surround the projecting spicules at the surface. The spongin becomes more abundant as the animal ages.

Spicules The megascleres of the axial and extra-axial skeletons are styles or subtylostyles (a,b) 1375-(1575)-1800 $\mu$ m. The echinating spicules are acanthostyles (d) (70-135 $\mu$ m, mostly 70-100 $\mu$ m) (rarely acanthoxea), and are best seen in longitudinal sections (they are rare or very rare in this species, cf. *Raspailia ramosa*). Divergent brushes are of slender styloids (c) 220-(320)-420 $\mu$ m. No microscleres.

Associations The surface brushes of spicules trap small particulate matter in which worms abound. Nematode worms live in the outer layer of *Stelligera stuposa* although there are fewer of them. It would be useful to have information on the abundance of nematodes from these two species from the same locality.

Voucher BELUM : Mc809. Portrush, Co Antrim.

Habitat In moderately exposed sites or sheltered sites with some tidal flow. Often with *Raspailia ramosa*, *Stelligera stuposa* and other Axinellids in open water. Maybe "on shells and *Lithophyllum*" (?) - confirmation would be valuable.

Distribution Widespread; west coasts of British Isles; Irish Sea; "Norway; Belgium; France; Spain; Portugal; Mediterranean."

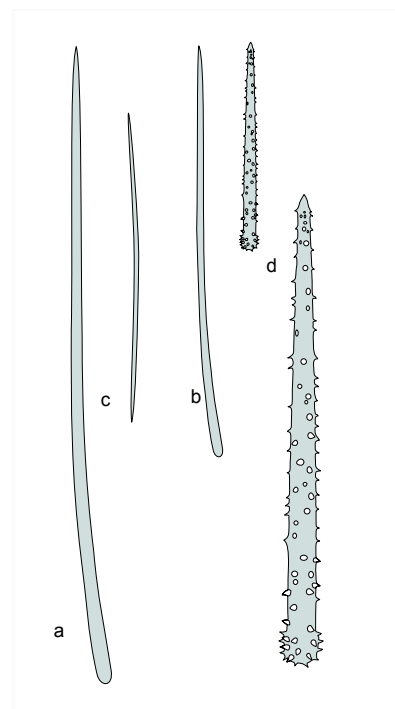

Identity	Can be very similar to some individuals of <i>Stelligera stuposa</i> (q.v.), especially in the middle size range (i.e. up to ca. 15cm high). A microscopic examination is always essential for positive identification as there is a considerable overlap between the two species. The only characters which may prove to be reliable are the bristly nature of the surface - evenly bristly in <i>Raspailia</i> , unevenly bristly in <i>Stelligera</i> ; and that <i>Raspailia</i> does not produce slime whereas <i>Stelligera</i> does. <i>Raspailia</i> tends to accumulate small particles of silt, whereas <i>Stelligera</i> tends to bind the silt into larger particles, probably because of the slime production (see Table under <i>Stelligera stuposa</i> ).
References	Arndt, 1935, p.83. Hiscock, Stone and George, 1983[1984], p.24.
Sources	B. E. Picton, S.M. Stone.
Editors	D. Moss, B.E. Picton.

### ***Raspailia ramosa* (Montagu, 1818:84)**

Family RASPAILIIDAE  
 Synonyms *Dictyocylindrus ramosus* (Montagu, 1818)  
 Bowerbank, 1866:103.

Form Branching-erect, the branch diameter variable in thickness (averaging about 1cm), maintaining the same thickness almost to the tip. More or less circular in cross-section, sometimes a little flattened. Branching is typically irregular, in all planes; branches rarely fuse. Stalked.

Photographs Longue Pierre, Guernsey. (B.E. Picton)

Colour Dark brown. This sponge gives a greenish sheen to alcohol and may stain the label purple. The dark brown colour of the tissue is still evident after sectioning and clearing.

Smell None.

Consistency Firm, elastic. The soft layer is easily rubbed from the strong axial core (?).

Surface Bristly (villose) with hairs of uniform length (?) which trap particles of silt. Ragged remnants of membrane may be seen clinging to the surface.

Apertures Oscules are apparent in the field on close inspection, scattered on the branches and often sub-terminal. They are obvious as dark spots in photo 33, but lost on preservation.

Contraction None.

Skeleton Plumoreticulate, with a dense axial condensation of reticulating spongin fibres, which are cored by subtylostyles and echinated by acanthostyles. There is a soft, extra-axial skeleton of long spicules radiating out at right angles from the core to pierce the surface. Divergent brushes of slender spicules surround the projecting spicules at the surface. The spongin becomes more abundant as the animal ages.

Spicules Megascleres of axial and extra axial skeletons are subtylostyles (a) 900-(1115)-1325 $\mu$ m "to 1600 $\mu$ m". The echinating spicules are acanthostyles (c) 90-(110)-125 $\mu$ m, best seen in longitudinal sections (these spicules are always frequent or common in this species, cf. *Raspailia hispida*). The divergent brushes consist of styloids (b) to ca. 350 $\mu$ m.

Voucher BELUM : Mc101. Portrush, Co Antrim.

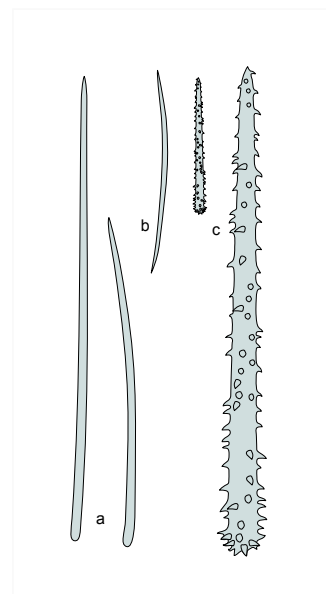

Habitat	Common on sublittoral rock and boulders from moderately exposed sites to sheltered sites with some tidal current. Tolerates some silt. The only <i>Raspailia</i> spp. so far known from harbours (?). Co-exists with <i>Raspailia hispida</i> and other Axinellids in open water.
Distribution	Recently known from Cornwall; Lundy ; Anglesey; Strangford Lough; Mull; W. coast of Ireland; Roscoff; Sussex; Channel Isles. Common on western coasts of the British Isles. Not found in the North Sea.
Identity	This is the only dark brown, branched, bristly sponge which is common, but beware other rarer <i>Raspailia</i> species whose live appearance is currently unknown. The presence of the typical acanthostyles will confirm <i>Raspailia</i> spp. and their shape and size are diagnostic for <i>Raspailia ramosa</i> . (Other branching - erect Raspailiids, which may be valid species, include; <i>Raspailia pumila</i> , <i>Raspailia rectangulus</i> , <i>Raspailia radiosus</i> , <i>Raspailia viminalis</i> , etc. <i>Raspailia virgultosa</i> occurs in the North Sea and has much larger acanthostyles.)
Reference	Arndt, 1935, p. 83. Hiscock, Stone and George, 1983[1984], p.24.
Sources	B.E. Picton, S.M. Stone, (D. Moss).
Editors	D. Moss, B.E. Picton.

### ***Endectyon delaubenfelsi* Burton, 1930: 492**

Family	RASPAILIIDAE
Synonyms	None.
Form	Branching-erect with a clearly differentiated stalk. Overall, the main branches tend to lie in one plane, but small branches can grow in different planes. Branching is very irregular, with a strong tendency to lateral coalescence. To about 6.5cms in height.
Photographs	Sark, Channel Isles. (B.E. Picton)
Colour	Golden yellow.
Smell	None.
Slime	
Consistency	Soft to compact.
Surface	Uneven, markedly tuberculate. Velutinous, moderate friction.
Apertures	Not visible.
Contraction	None.
Skeleton	Plumoreticulate with a dense axial condensation of reticulating small styles and acanthostyles, that form short bundles rising to the surface in the extra-axial skeleton. Brushes of long styles penetrate the surface.
Spicules	Most of the spicules present are smooth styles (a). The short styles may be straight, or curved towards the head, 155-245 x 4-7µm. The long styles are smooth and usually straight, 600-1060 x 6-12µm. Occasional styles show characteristic deformations, e.g. branching points, or a short style crossing the main one. The acanthostyles (b) are sparsely spined, sometimes with a characteristic rosette of 4-6 spines at the head or point. They appear to be rarer than the deformed styles, and it is possible to demonstrate a transition in form between the two types of spicules. Once located in a section the shape of the acanthostyles is very distinctive. There are no microscleres.
Voucher	BELUM : Mc705. Lundy Is., Bristol Channel.
Habitat	The two specimens in GA's collection were found at the interface between bedrock and gravel. More habitat information is required. From 25-80m.

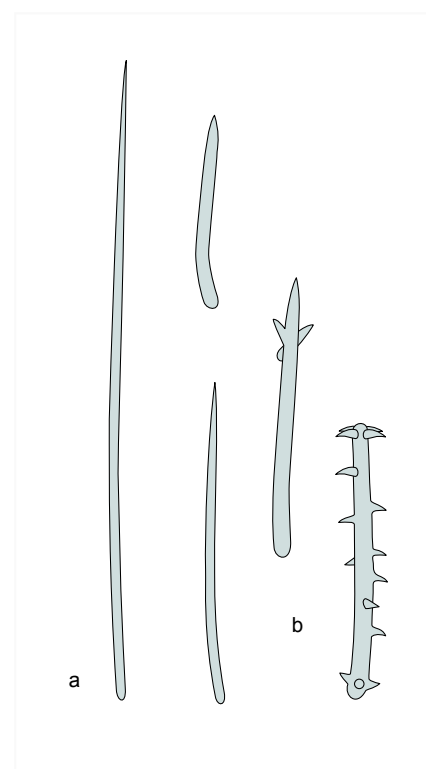

Distribution	Plymouth, Salcombe, Lundy, Channel Isles, Brittany.		
Identity	The shaggy appearance and tuberculate surface are characteristic. Another <i>Endectyon</i> species, <i>E. teissieri</i> Cabioch 1968 is known from Brittany, but has an external form more like that of <i>Axinella flustra</i> (q.v.), a different skeleton, and long strongyles in place of the long styles.		
	A superficial resemblance to <i>Stelligera rigida</i> (q.v.) is possible, but the latter is more squat and bush-like, and slimy. Burton (1930) maintains that it is impossible to differentiate <i>Endectyon delaubenfelsi</i> from <i>Raspailia ventilabrum</i> (Bowerbank, 1866: 100) externally, but the latter species has not yet been recognised in this guide.		
References	Burton, 1930, p.492. Cabioch, 1968, p.224.		
Source	G. Ackers (B. Picton).	Editors D. Moss, B.E. Picton.	Draft 1 2/90

## *Eurypon major* Sara & Siribelli, 1960: 60.

Family	EURYPONIDAE
Synonyms	None in common use.
Form	A thin (to 0.5mm) crust overgrowing rock surfaces, with an uneven, bubbly appearance. The spicules penetrating the surface may trap silt.
Photographs	Lough Hyne, Cork. (B.E. Picton)
Colour	Vivid red.
Smell	None.
Slime	None.
Consistency	Hard to describe since a very thin crust.
Surface	Villose, with long fine styles and shorter fine oxea penetrating the surface.
Apertures	Scattered, inconspicuous. Oscular rims are transparent with small blobs of red tissue.



Contraction	None.
Skeleton	<i>Eurypon</i> spp. all have skeletons with a basal layer of acanthostyles perpendicular to the substrate and with their heads resting on the substrate. Very long tylostyles, also perpendicular to the substrate with heads in the basal spongin layer, are scattered amongst the acanthostyles. Where these tylostyles penetrate the surface they are echinated by a brush or fan of fine styles or oxea. In <i>Eurypon major</i> these echinating spicules are fairly stout oxea, occasionally with rounded proximal ends.
Spicules	Tylostyles 1440µm - 2210 x 10-17, entirely spined acanthostyles ca. 85-165µm (? up to ca. 125µm - 164µm). Ectosomal oxea measure ca. 385-525 x 3-7µm.
Voucher	BELUM : Mc1338. Lough Hyne, Cork.
Habitat	Rocky surfaces. Common on vertical surfaces in L. Hyne.
Distribution	North and west coasts of Ireland, Mediterranean.
Identity	All <i>Eurypon</i> spp. are thin crusts and several are red. <i>Eurypon</i> and <i>Hymenaphia stellifera</i> can be distinguished from other red crusts by the very long tylostyles that project 1 to 1.5mm through the surface. <i>Eurypon major</i> is the only <i>Eurypon</i> with abundant thick oxea present in the surface, and the dimensions of these oxea distinguish

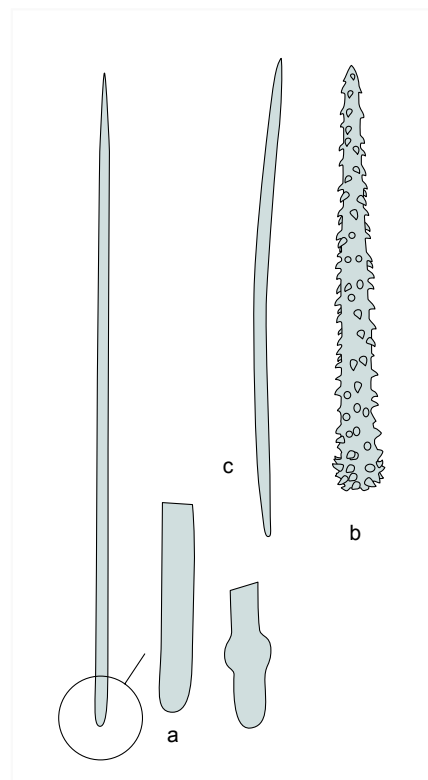

this species from *Eurypon lacazei*.

Reference Sara and Siribelli, 1960, p.60.

Sources B. Picton.

Editors D. Moss, B.E. Picton.

Draft 1 2/90

## *Hymenaphia stellifera* (Bowerbank, 1874:319)

Family RASPAILIIDAE

Synonyms

Form Very thin sheet, almost impossible to remove from the substratum except in tiny pieces.

Photographs W. Blackstone, Skomer Island. (B.E. Picton)

Colour Typically orange/red.

Smell None.

Consistency Too thin to determine.

Surface Usually silt covered with regularly spaced red raised bumps showing through, occasionally clean with these raised bumps. Villose, due to scattered long spicules which penetrate the surface.

Apertures The oscules are small, at the summits of the raised bumps mentioned above. No ostia visible.

Contraction None, difficult to determine.

Skeleton The skeleton consists of a basal layer of short, stout tylostyles with distinctive outer ends consisting of a ball of spines, mixed with scattered long tylostyles which penetrate the surface. Where the latter penetrate the surface there is a brush of fine styles. (see skeletal drawing for *Eurypon major*.)

Spicules Three categories of megasclere and no microscleres are present. The largest megascleres are long tylostyles with rounded heads and smooth shafts. Shorter tylostyles with distinctive spined ends and flask-shaped rounded heads are abundant. Fine, thin styles are frequent, forming brushes at surface.

Voucher BELUM : Mc

Habitat Mostly found in deeper water, below 30 metres, but occasionally as shallow as 20m. Tolerant of silt, and found in sheltered places on dead shells as well as on bedrock in both exposed and sheltered locations.

Distribution "British Isles; France; Mediterranean." Known recently from Strangford Lough, St Kilda, Skomer, Stags of Broadhaven, Co Mayo, Lough Hyne. Probably common but rarely recorded because of its extremely thin nature.

Identity The short spicules with spined ends are very distinctive and are not found in any other British species. In the field the thin red sheet, often silt-covered, is difficult to distinguish from some *Eurypon* species, but it is even thinner than most of these.

Reference

Sources B.E. Picton.

Editor B.E. Picton

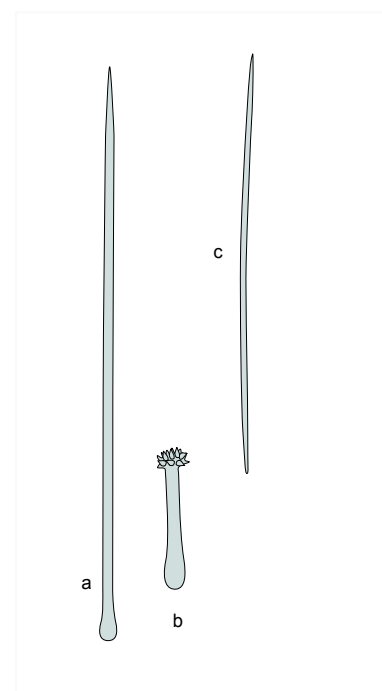

***Clathria barleei* (Bowerbank, 1866: 333).**

Family	MICROCIONIDAE (= CLATHRIIDAE)
Synonyms	<i>Isodictya barleei</i> (Bowerbank, 1866), <i>Clathria foliata</i> (Bowerbank, 1874), <i>Halichondria foliata</i> (Bowerbank, 1874), <i>Isodictya laciniosa</i> (Bowerbank, 1874), together with a number of others, see van Soest and Stone, 1986.
Form	Massive, lamellate or with very flattened branches; irregular lamellae with conulate projections. Sizes to 20cm high and across the base.
Photographs	BELUM: Mc490. SW of Lunga, Firth of Lorne, Hebrides. (B.E. Picton)
Colour	Pale beige, yellow or green. When dried, becomes orange-brown or purple.



Smell	None
Slime	None
Consistency	Fairly compressible.
Surface	Rugose, with very porous appearance; "open" in appearance.
Apertures	Oscules are at the edges and on the faces of the lamellae, on conulate projections at regular intervals. Excurrent channels converging on the oscules are obvious. Pores are conspicuous and distributed fairly uniformly over the surface.
Contraction	None
Skeleton	A reticulate skeleton of curved smooth styles, sparsely echinated with entirely spined acanthostyles. The ectosomal skeleton consists of tangential, relatively slender, subtylostyles. Very fine toxa are present in internal membranes.
Spicules	Megascleres are smooth styles (a), which are usually abruptly curved near the head, and taper to a fine point, size range at least 350-580µm, and slender subtylostyles (b) with microspined heads in the ectosome. Entirely spined acanthostyles (c), ca. 90µm, occasionally echinate nodes in the interior. Microscleres are palmate isochelae (d), ca. 18-21µm and toxa (e) with an abrupt central flexion, ca. 260-500µm. Some of these categories may be absent in a given specimen.

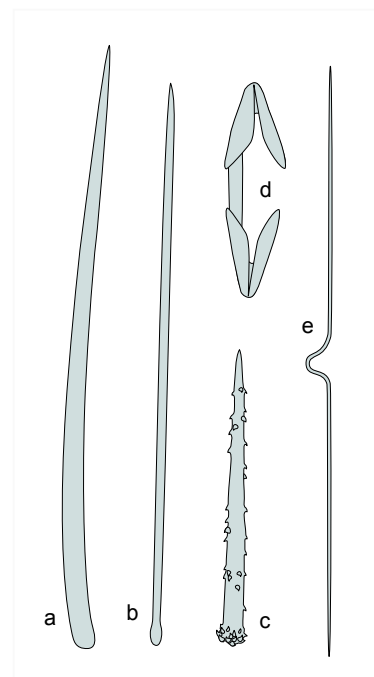

Voucher	BELUM : Mc490. Lunga, Firth of Lorne, Scotland.
Habitat	Cirralittoral, on <i>Lophelia</i> , rock, stones, etc. to depths in excess of 100m, usually below 40m.
Distribution	Arctic, southwards to west coasts of Ireland and France. Scarce within diving range, but recently recorded from Rockall; Insh Is., Firth of Lorne; Loch Sunart, Sound of Mull; and Rathlin Is., and the Maidens, N. Ireland.
Identity	The spiculation of this species is very variable, and any of the categories toxa, acanthostyles, isochelae or acanthostyles and isochelae, may be absent or rare in a given specimen. This has in the past caused specimens to be assigned to a variety of species, genera and families.
References	Bowerbank, 1866, p.333; 1874, pp. 145, 198, 219. van Soest and Stone, 1986, p.46.

Source	D. Moss, B.E. Picton.	Editors D. Moss, B.E. Picton.
		Draft 1 2/90

***Antho involvens* (Schmidt, 1864:37)**

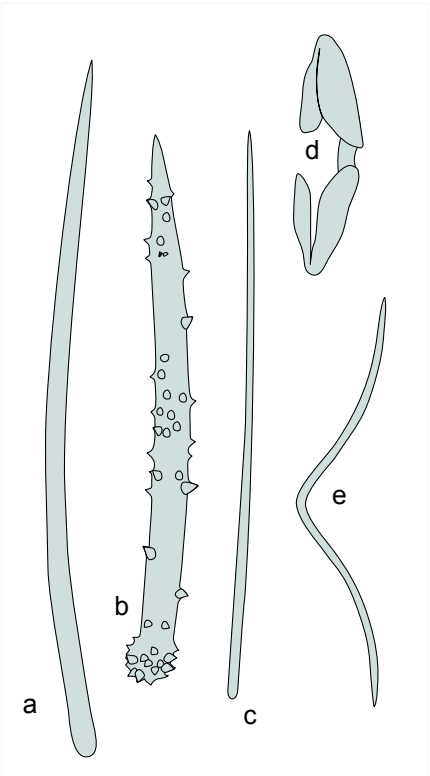
Family	CLATHRIIDAE (=MICROCIONIDAE)	
Synonyms	<i>Isodictya beanii</i> Bowerbank, 1866:334, <i>Dictyoclathria beanii</i> (Bwk., 1866) Burton, 1933:504, <i>Myxilla involvens</i> Schmidt, 1864:37. <i>Antho inconstans</i> Topsent, 1925 is considered to be a distinct species.	
Form	Thin sheet forming extensive patches on rock surfaces. In encrusting form it can be easily detached from the substrate. The literature claims "Can become branched - erect, sometimes stalked", but BEP considers this to refer to a separate species.	
Photographs	BELUM: Mc1363. W. Blackstone, Skomer Island, south Wales. (B.E. Picton)	
Colour	Watery orange to bright red.	
Smell	None.	
Consistency	Fairly tough sheet, which holds together well when scraped off.	
Surface	Smooth, slightly hispid.	
Apertures	Oscules conspicuous, spaced regularly across the surface, with slightly raised conical rims; circular and consistent in size. Ostia apparent on close examination. Excurrent channels are inconspicuous, not at the surface of the colony, but their ends are visible inside the oscules.	
Contraction	None to slight.	
Skeleton	An anisotropic reticulation, with a triangular or quadrangular mesh of megascleres (acanthostyles) (b) of varying sizes, many sparingly spined, often quasi-echinated by smooth megascleres at the internodes of the net. Long smooth megascleres (styles) (a) pierce the surface. Fine accessory ectosomal styles (c) are present.	
Spicules	Megascleres of the main skeleton are acanthostyles (b), (never acanthostrongyles) entirely but often sparingly-spined; typically 145-160µm in length. Ectosomal styles (a) are ca. 500µm. The accessory spicules are fine styles or subtylostyles (c) with microspined heads 330 x 4µm. Microscleres are palmate isochelae (d) (ca. 17-23µm), which may be rare, and toxa (e), which may be abundant.	
Voucher	BELUM : Mc1363. Skomer Island.	
Habitat	Vertical or steeply inclined rock faces in both sheltered and exposed places.	
Distribution	"South coast of England; France; Spain; Mediterranean etc." Known recently from Skomer; Rathlin Island. Confusion with <i>Antho inconstans</i> (q.v.) leaves previous records in doubt.	
Identity	Many Clathriids form red sheets, but the spicule complement of <i>Antho</i> spp. is quite different from that of <i>Microciona</i> spp. Another British <i>Antho</i> sp. possibly to consider is <i>A. dichotoma</i> , a branching - erect, stalked species of unknown colour and almost identical spiculation. So far this has only been recorded from deeper water (82m +). <i>Antho</i> is also easily confused with <i>Plocamilla coriacea</i> (Bwk 1874:228) (q.v.), which forms bumpy sheets and may also grow on other sponges. Acanthostrongyles are the predominant megascleres of the main skeleton in <i>Plocamilla</i> , otherwise the spicule complement is similar for both species (with slight size differences).	
References	Arndt, 1935, p.81. Lévi, 1960, pp.76-78.	
Sources	B.E. Picton, S.M. Stone. Editors D. Moss, B.E. Picton.	

***Antho inconstans* (Topsent, 1925 : 664).**

Family CLATHRIIDAE (=MICROCIONIDAE)  
 Synonyms *Plocamia inconstans* Topsent, 1925.  
 Form Thin sheet forming extensive patches on rock surfaces or on other sponges (e.g. *Stelletta grubii*).  
 Photographs BELUM: Mc1826. S. of the Neck, Skomer Island, south Wales. (B.E. Picton)  
 Colour Orange-red.  
 Smell None.  
 Consistency Fairly tough sheet, which holds together well when scraped off.  
 Surface Lumpy and irregular, with a slightly velvety appearance, similar to *Microciona spinarcus*.

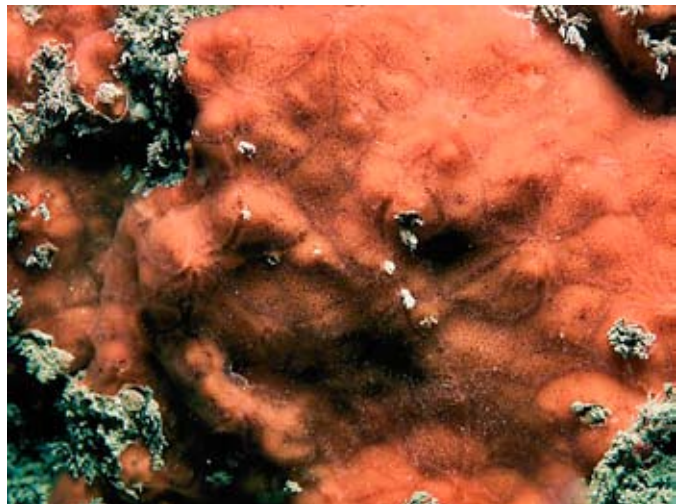

Apertures Oscules inconspicuous, scattered, irregular in shape and size. Excurrent channels are generally conspicuous, converging on the oscules and forming irregular stars.

Contraction None to slight.

Skeleton An anisotropic reticulation, with a triangular or quadrangular mesh of megascleres (acanthostyles) of varying sizes, quasi-echinated by smooth megascleres at the internodes of the net. Longer smooth megascleres (styles) pierce the surface, but these are much shorter than the corresponding spicules in *Antho involvens*. Fine accessory ectosomal spicules are present.

Spicules Megascleres of the main skeleton are acanthostyles (b) and acanthostrongyles (c). The acanthostyles have a region of denser spination near the head and near the tip, and the smooth point itself is very short and abrupt. Typically ca. 135-155µm in length. Smooth ectosomal styles (a) ca. 200µm in length, slightly fusiform with a constriction above the head. The accessory spicules are fine subtylostyles (d) (sometimes styles) with microspined heads (this may not be visible with a light microscope). Microscleres are palmate isochelae (f) (ca. 17µm), which may be rare, and toxa (e), which may be abundant.

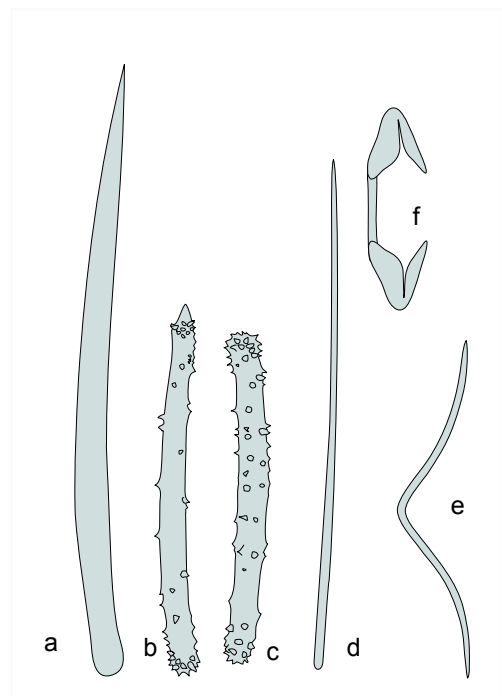

Voucher BELUM : Mc1349. Skomer Island.

Habitat Vertical or steeply inclined rock faces in both sheltered and exposed places. May be on other sponges such as *Stryphnus ponderosus* and *Stelletta grubii*.

Distribution "South coast of England; France; Spain; Mediterranean etc." Known recently from Lough Hyne, Co. Cork; W. Anglesey; Skomer; N. Cornwall; Jersey; Guernsey.

Identity Many Clathriids form red sheets, but the spicule complement is quite different from that of *Microciona* spp. The characters given here and for *Antho involvens* should distinguish these two species, which have often been synonymised in the past. *Antho inconstans* is easily confused with *Plocamilla coriacea* (Bwk 1874:228), which forms bumpy sheets and may also grow on other sponges, indeed the two species can be found growing alongside each other. Acanthostrongyles are the predominant megascleres of the main skeleton in *Plocamilla*, and the acanthostyles do not show the band of spines near the tip as in *Antho inconstans*, looking more like those in *Antho involvens*. Otherwise the spicule complement is similar for these three species (with slight size differences).

References Lévi, 1960, pp.78-80 as *Antho involvens* var. *inconstans*.

Sources B.E. Picton, S.M. Stone. Editors D. Moss, B.E. Picton.



***Antho coriacea* (Bowerbank, 1874: 228).**

Family	CLATHRIIDAE (= MICROCIONIDAE)
Synonyms	<i>Plocamilla coriacea</i> .
Form	Moderately thin sheets, with a rounded rugose surface, typically ca. 5mm thick.
Photographs	BELUM: Mc1549. Goleen Cliff, Lough Hyne, Cork. (B.E. Picton)
Colour	Bright orange-red or ochre yellow.
Smell	None?
Slime	Not noticeable.
Consistency	Fairly firm, holds together well when collected, but somewhat crumbly and easily torn.
Surface	Fairly smooth in appearance, with moderate friction; tuberculate, uneven. N.B. Lévi (1960) describes it as “finely hispid”.
Apertures	Oscules are inconspicuous.
Contraction	Slight - difficult to determine.
Skeleton	The main skeletal feature is fairly regular, isotropic and dense reticulation of acanthostrongyles, with acanthostyles also present, the latter often in ‘upright’ positions. There are also a few larger styles, associated with ascending fibres and penetrating the surface (sometimes quasi-echinating the fibres). Slim subtylostyles form brushes at the surface. Very variable quantities of spongin reinforce the spicule fibres.
Spicules	The megascleres include acanthostrongyles 80-100µm; acanthostyles of 110-190µm, the larger being very lightly spined at the head only; styles of ca. 300-400µm. The subtylostyles measure ca. 200-250 x 2-4µm. The microscleres are palmate isochelae, ca. 11-15µm and toxa which predominantly fall into two size groups: 30-60µm (relatively fine) and 130-180µm (more sturdy). The larger toxa may have spined points.
Voucher	BELUM : Mc890. Saltee Islands, Wexford.
Habitat	Vertical or steeply inclined rock faces from the shallow sublittoral downwards. Often found encrusting other sponges, such as <i>Stelletta grubii</i> and <i>Stryphnus ponderosus</i> . Most frequent in sites with moderate to strong tidal streams.
Distribution	Known recently from Ireland, Anglesey.
Identity	In appearance this species is quite similar to many other of the troublesome ‘red crust’ Clathriids (especially <i>Antho involvens</i> ), but a bright orange red surface with a bumpy appearance is fairly recognisable. The spicule complement, with a predominance of acanthostrongyles, is distinctive (see note for <i>Antho involvens</i> ).
Reference	Lévi, 1960, p. 80.
Source	D. Moss, B.E. Picton (S.M. Stone).

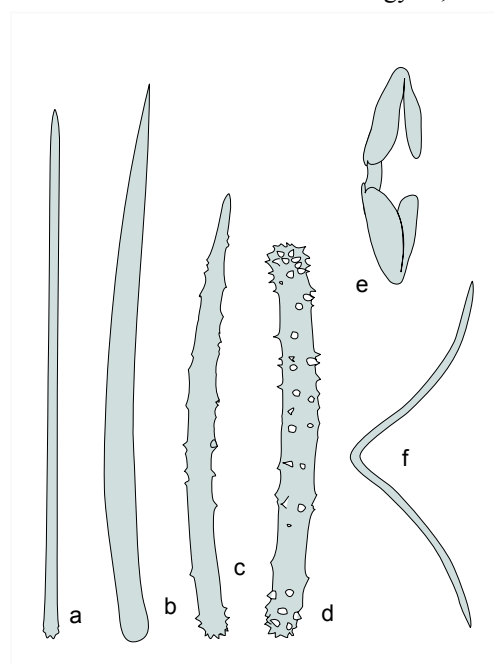

Editors D. Moss, B.E. Picton.  
Draft 1 2/90

***Ophlitaspongia papilla* (Bowerbank, 1866:378)**

Family CLATHRIIDAE (=MICROCIONIDAE)

Synonyms *Ophlitaspongia papilla* Bowerbank, 1866:378.

Form Thin sheets, usually 2 - 3mm thick, but can develop into cushions of uniform thickness up to 10mm thick. Diameter of the animal may be up to 10cm.

Photographs The Rapids, Lough Hyne, Cork. (B.E. Picton)

Colour Deep orange - red. The pigment squeezes out readily.

Smell "Not strong" - "none" (?).

Consistency Moderately firm and elastic. "Compressible, resilient. Breaks somewhat in the manner of a soft biscuit."

Surface Very finely granular, "even, hispid", "minutely wrinkled". The surface has a smooth dense appearance which is quite distinctive.

Apertures The oscules are conspicuous and evenly distributed in a regular fashion between 5 and 10mm apart over the surface. Neat, round and mostly flush with the surface, but the margins can be raised slightly above the surface. "Occasionally sub-fistular."

Contraction None.

Skeleton Very characteristic. In cross-section a ladder-like skeleton of spongin can be seen, which forms an anisotropic reticulation of well developed fibres. The primary ascending fibres are semi-cored by plumosely arranged megascleres, which often quasi-echinate the fibres. The secondary connecting fibres usually do not contain spicules. Accessory spicules are usually interstitial, rather than at the surface.

Spicules The principal megascleres of the main skeleton are short fat styles or subtylostyles (a) 110-(117)-130µm. The accessory spicules are thin subtylostyles (b) 105-(118)-130µm. The microscleres are toxa (c) with smooth tips 50-(55)-60µm. Chelae are absent.

Voucher BELUM : Mc588. Rutland Harbour, Donegal.

Habitat On rock, commonly under boulders on the lower shore and also in the shallow sublittoral (to 5m CD). "On clean rock, shells, *Fucus*," and *Laminaria* stipes in areas of strong water movement (either tidal or wave action).

Distribution "British Isles; France and Spain." A common shore species with recent records from south-west England, western Ireland, Strangford Lough and Tiree. Fry (1971) did research on this species from the Menai Straits and Anglesey.

Identity Superficially *Ophlitaspongia seriata* could be confused with several other species. However the spiculation is distinctive and the form, colour and habitat make it readily identifiable. It could be confused with *Amphilectus fucorum* (q.v.) but when alive the strong smell of *Amphilectus* can be used as an initial indication; *Amphilectus* has a much softer consistency. It could also be confused with *Microciona atrasanguinea* (q.v., a shallow sublittoral species which also forms thin sheets), but whereas *Ophlitaspongia* can be peeled off the rock, *Microciona* usually crumbles and tears and is much thinner. The spiculation is also very different.References Arndt, 1935, p.82.  
Bowerbank, 1866, p.377; 1874, p.167.  
Fry, 1971, pp.158-178.  
Lévi, 1960, p.64.  
Simpson, 1968, pp.37, 89-119.

Sources B.E. Picton, S.M. Stone.

Editors R. Earll, D. Moss, B.E. Picton.

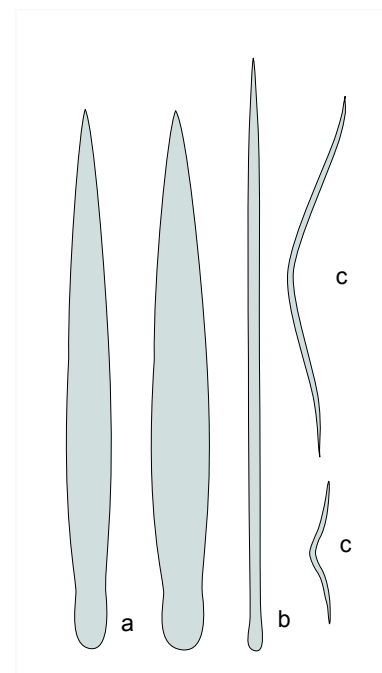

***Microciona atrasanguinea* Bowerbank, 1862:824.**

Family	CLATHRIIDAE (=MICROCIONIDAE)
Synonyms	<i>Plumohalichondria atrasanguinea</i> (Bowerbank, 1862:824) Hanitsch, 1890:207
Form	Thin sheets covering extensive areas, typically 3mm thick by up to 30cm diameter. In the literature it has been reported as a cushion, but this may be the result of the sponge growing over a saddle oyster (BEP). Typically looks like a patch of red paint.
Photographs	BELUM: Mc140. Lee's Wreck, Strangford Lough, Down. (B.E. Picton)
Colour	Bright red, scarlet or blood red. The blood-red sublittoral form is described here, and may be a distinct species from the scarlet one which seems to occur both in the littoral and sublittoral.
Smell	None.
Consistency	Difficult to determine because of thinness of sheet but fairly soft; difficult to scrape off - it crumbles and tears.
Surface	With little structure - conforms closely to the underlying substrate. Excurrent channels are clearly visible as dark branching lines converging on the oscules. Slightly velvety appearance; minutely porous. "Tuberculate, hispid; often creviced" according to Lévi (1960).
Apertures	Oscules have slightly raised transparent rims, apparent mainly because of converging excurrent channels. These oscules are "numerous and regularly spaced over the surface".
Contraction	Difficult to determine.
Skeleton	In the littoral form (juvenile) the skeleton is usually 'Hymedesmoid', with both the principal spicules of the main skeleton (usually styles) and also the auxiliary spicules (acanthostyles) standing up from a basal sheet of spongin, the bases of the spicules being implanted in the spongin and the points directed towards the surface. Slender accessory spicules (subtylostyles) are scattered throughout. In thicker sublittoral specimens (adult form) the skeleton becomes 'plumose'. The main skeleton then consists of plumose columns of spicules incorporating spongin 'raised' from the basal layer of the juvenile form. These are in turn echinated by smaller spicules (acanthostyles). Slender ectosomal spicules are present.
Spicules	Principal spicules of the main skeleton are subtylostyles (a) (rarely sparingly spined at the base) which measure 220-(250)-280µm long x 10µm thick and 110-(130)-145µm; (note however that Lévi (1960) gives a size range of 110-375µm. Auxiliary megascleres are entirely-spined acanthostyles (b), 80-(90)-135µm. Slender accessory subtylostyles (c) measure 225-(260)-355µm and have microspined heads. The microscleres comprise palmate isochelae (d) 8.5-12µm, and smooth tipped toxa (e), which may be numerous, 100-125µm and 18-40µm.
Voucher	BELUM : Mc821. Strangford Lough, Down.
Habitat	Vertical surfaces of rock or wrecks. Boulders in brackish conditions. Encrusting pebbles in areas of strong current (Menai Straits) in the Littoral zone.
Distribution	"Atlantic coasts of Europe (from Shetlands southwards), Mediterranean etc." Known recently from Strangford Lough; Rathlin Island; Menai Straits; Dauceddau, Milford Haven. Littoral or shallow sublittoral.

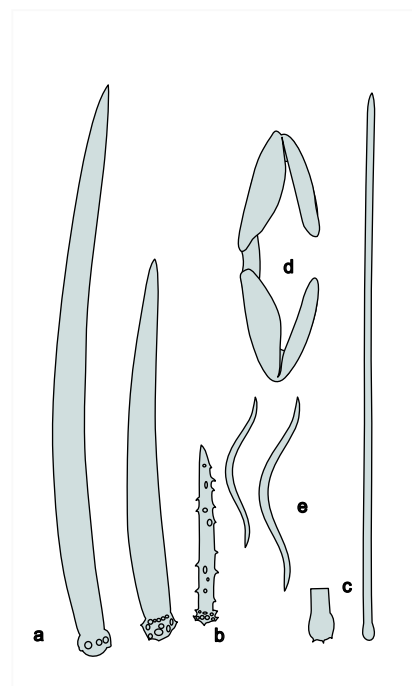

Identity	<i>Microciona</i> species and other Clathriids often form thin reddish sheets. The dendritic branching of the excurrent channels of this species may be characteristic but the spicules should always be checked for a positive identification. Superficially it may be confused with <i>Ophlitaspongia seriata</i> (q.v.), but note the regular arrangement of oscules in the latter species which is not so apparent in <i>M. atrasanguinea</i> .	
References	Arndt, 1935, p.78. Lévi, 1960, p.72.	
Sources	B.E. Picton, S.M. Stone, (D. Moss).	Editors D. Moss, B.E. Picton.

### ***Microciona armata* Bowerbank, 1866.**

Family	CLATHRIIDAE (= MICROCIONIDAE)
Synonyms	None in general use.
Form	Thin sheet covering rock or bivalve shells, to thin crust 1-5mm thick.
Photographs	BELUM: Mc1736. Calf of Man, Isle of Man. (B.E. Picton)
Colour	Light red, reddish-orange, "blood-red". Brown when dried.
Smell	None
Slime	None.
Consistency	Difficult to determine in thin specimens, but rather brittle in thicker ones.
Surface	Smooth to casual inspection, but very finely hispid.
Apertures	Oscules have transparent converging excurrent channels.
Contraction	None
Skeleton	Typically microcionid with ascending plumose bundles of large, sparsely spined acanthostyles, echinated by smaller acanthostyles. (See diagram on page 36). These bundles rarely branch, so thicker specimens tend to break with a right-angled edge, and bundles separate easily. There is a surface layer of subtylostyles. Toxa and palmate isochelae are frequent throughout the skeleton.



Spicules	The principal megascleres are almost smooth acanthostyles (a), slightly spined around the head, ca. 200-780 x 8-15µm. Secondary echinating acanthostyles (b), ca. 100-200µm, are entirely and heavily spined, with larger, recurved, spines towards the tips. Slender (sub)tylostyles (c), ca. 150-350µm (300-450µm according to van Soest and Stone), with microspined heads, are present in the surface. (It may be difficult to see these spines). Microscleres include palmate isochelae (d), ca. 7-23µm and toxa (e), ca. 45-250µm.
----------	--

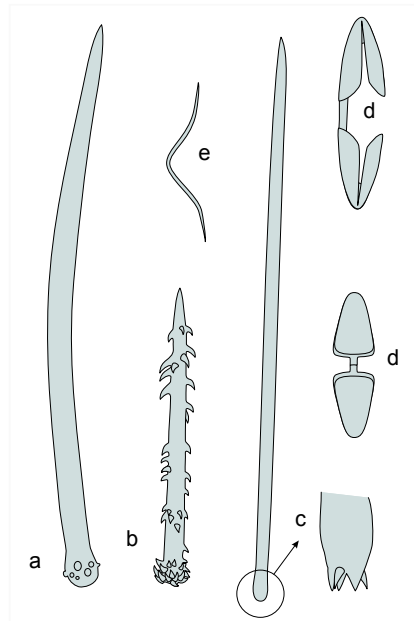

Voucher	BELUM : Mc1643. Strangford Lough, Down.
Habitat	On bivalve shells on muddy sediments, rocks and boulders in sheltered sites, and also on bedrock in strong tidal streams. Intertidal to 180 m.
Distribution	"N. Atlantic": White Sea to Mediterranean. Coasts of Ireland, southern and western Britain, Channel Isles. Recently known from Calf of Man, Strangford Lough, Lough Hyne, Skomer Is.

Identity	The validity of the large range in spicule sizes given above is uncertain (but see Levi, 1960, p.73, from where it is apparent that spicule sizes tend to vary considerably in this species). In any given specimen such wide variation is unlikely to occur. Separation of the various microcionid 'red crusts' is difficult and needs careful microscopic examination. Lévi (1960, p.66) gives a key to the genus <i>Microciona</i> . This species does have
----------	--

extremely large, recurved spines on the smaller acanthostyles, which are quite distinctive. A distinct species has recently been discovered near Skomer Island which appears to be undescribed. It forms thick, bright red sheets, and has a spicule compliment similar to *Microcionia armata* but with smaller spines on the secondary acanthostyles.

References Arndt, 1935, p.78.  
Bowerbank, 1866, p.130; 1874, p.60.  
van Soest and Stone, 1986, p.45.

Sources B.E. Picton (D. Moss).

Editors D. Moss, B.E. Picton.  
Draft 1 2/90

### ***Microcionia strepsitoxa* Hope, 1889.**

Family CLATHRIIDAE (= MICROCIONIDAE)

Synonyms None in common use.

Form Thin crust, to 20+cm<sup>2</sup>

Photographs BELUM: Mc1731. Calf of Man, Isle of Man. (B.E. Picton)

Colour Red, orange-red.

Smell None.

Slime None.

Consistency Hard to determine; “comes away in scraps”.

Surface Conforms closely to underlying substrate. Excurrent channels often clearly visible.

Apertures Oscules large, distinct, with slightly raised rims, at centre of system of conspicuous, convergent, sub-surface channels.

Contraction Hard to determine. Fragments tend to curl up in alcohol (which becomes orangeish).

Skeleton Typically microcionid, see *M. atrasanguinea* and skeletal diagram for *Microcionia armata* on page 36. According to Levi (1960, p.67) there is some tendency for the longer principal megascleres in the plumose columns to be found towards the surface.

Spicules Principal megascleres are acanthostyles (a), perhaps slightly curved, with spines at the head only (these spines may be almost invisible); size 350-700 x 5-7µm. Echinating acanthostyles (c), are straight to slightly curved, and covered with spines; 70-200 x 4-6µm. Auxiliary subtylostyles (b), 150-500 x ca. 2-5µm, may have rugose or very lightly spined heads. Microscleres are palmate isochelae (d), 12-20µm (in Mediterranean, 11-15µm according to Levi, 1960) and toxa of two types (e): ca. 40-140µm with large central flexion and ca. 200-460µm with a very small, somewhat twisted, central flexion.

Voucher BELUM : Mc1743. Calf, Isle of Man.

Habitat Vertical rock surfaces in regions of considerable water movement. Also *Aequipeecten* valves, stones, etc. Littoral, infra- and circalittoral.

Distribution Channel, Atlantic, Mediterranean. Known recently from Anglesey, Calf of Man, SW and NE Ireland, Azores.

Identity Difficult, if not impossible, to separate visually from various other “red crusts”. The conspicuous star-like arrangement of channels converging to the oscules (best seen in close-up photographs) may give a clue. Microscopically the presence of large toxa with a small twisted, central flexion is distinctive, though some other *Microcionia* species share this feature. Occasionally in aberrant specimens the isochelae may be scarce.

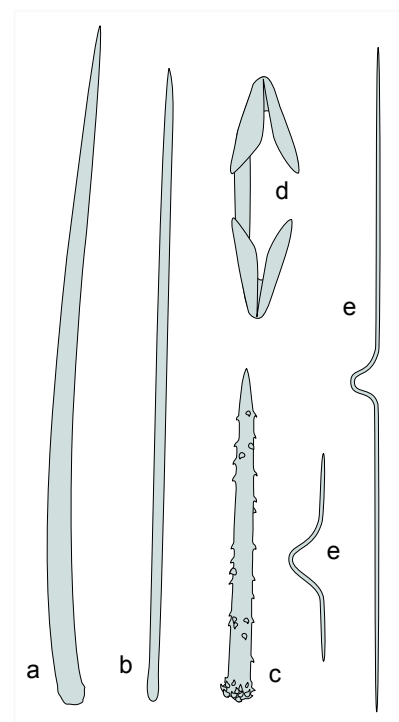

Reference Lévi, 1960, p.67.

Source D. Moss, B.E. Picton.

Editors D. Moss, B.E. Picton.

Draft 1 2/90

## *Microciona spinarcus* Carter and Hope, 1889:101.

Family CLATHRIIDAE (=MICROCIONIDAE)

Synonyms None in common use.

Form A thin sheet typically 4mm thick which covers rock surfaces in patches 15cm or more in diameter.

Photographs BELUM: Mc1742. Calf of Man, Isle of Man. (B.E. Picton)

Colour Yellow to pale orange.

Smell None

Consistency Difficult to determine in thin sheet.

Surface Slightly irregular and velvety with many small round inhalant pores and excurrent channels running to oscules.

Apertures Oscules are inconspicuous, with slightly raised transparent margins. The large hole in the photograph is really a dead barnacle although oscules are associated with it.

Contraction Oscules and excurrent channels collapse on removal from water.

Skeleton Typical *Microciona* skeleton - see description for *M. atrasanguinea*. Plumose columns of the principal skeletal megascleres are supported by spongin and echinated by smaller auxiliary megascleres (acanthostyles). Slender ectosomal spicules are also present.

Spicules Principal megascleres are basally-spined styles (a), 340-480µm. Echinating auxiliary megascleres are entirely-spined acanthostyles (b), 80-205µm. The slender accessory ectosomal spicules are subtylostyles (c), ca. 200-225µm. Microscleres are palmate isochelae (d), ca. 6µm and 11µm (which may be very rare), and thick toxa (e) (ca. 200µm) with strongly spined tips. These may be common.

Voucher BELUM : Mc1742. Calf, Isle of Man.

Habitat Common on vertical rock faces in exposed places; under boulders in rapids - seems to favour strong water movement. Frequently associated with *Alcyonium digitatum* and *Corynactis viridis*. "Found growing on *Pecten*."

Distribution "British Isles (type locality is Hastings); France; Spain." Known recently from Lough Hyne; N. coast of Donegal; N. coast of Co. Antrim; Calf of Man; St Kilda; Lundy.

Identity Difficult to distinguish from other encrusting orange species but the details of the surface may enable provisional identification. Examination of the spicules is essential and even then it may be difficult to distinguish from *Microciona fallax*, though toxa seem to be very scarce in the latter species.

References Arndt, 1935, p.79.

Lévi, 1960, p.76.

Sources B.E. Picton, S.M. Stone.

Editors D. Moss, B.E. Picton.

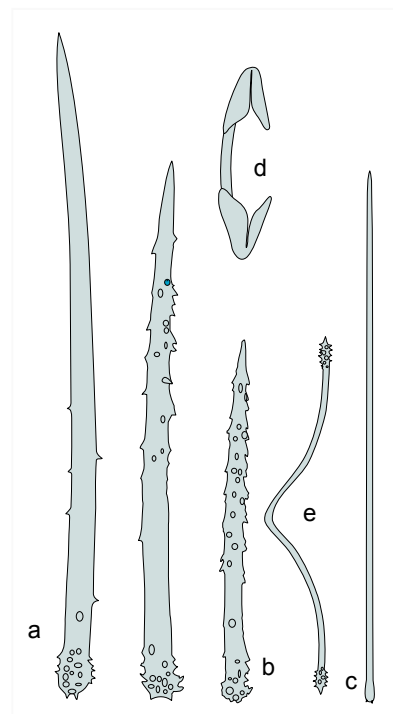

***Microciona fallax* (Bowerbank, 1866)**

Family	CLATHRIIDAE (=MICROCIONIDAE)
Synonyms	Referred to as <i>Microciona</i> sp. 'A' in a previous edition of this guide.
Form	Thin sheet or cushion covering rock in patches to 15cm or more in diameter.
Photographs	
Colour	Red to reddish-orange.
Smell	?
Consistency	Crumbly.
Surface	Bumpy-rough. Excurrent channels may be obvious.
Apertures	The oscules are fairly regularly distributed and reasonably obvious because of the presence of converging channels.



Contraction	Some, especially of the oscules.
Skeleton	Typical <i>Microciona</i> with plumose columns of large, nearly smooth, acanthostyles echinated by smaller, entirely-spined acanthostyles. There is a surface layer of subtylostyles and very abundant minute chelae. Toxa may be rare and not present in all specimens. Fine flexuous subtylostyles may be common, scattered throughout the tissue.
Spicules	Spiculation is similar to that of <i>Microciona spinarcus</i> . The toxa taper to points and are sparsely spined near their ends.
Voucher	BELUM : Mc1763. Calf, Isle of Man.
Habitat	On vertical rock faces in exposed places with strong wave action or tidal streams.
Distribution	Known from the south and west coasts of Ireland: Saltee Is., Co. Wexford; Sherkin Is., Co. Cork; Rathlin O'Birne Is., Co. Donegal.
Identity	This sponge is very similar to <i>M. spinarcus</i> (q.v.). The presence of flexuous subtylostyles and scarce microspined toxa seems to be characteristic. This, combined with the bumpy surface, may be diagnostic.

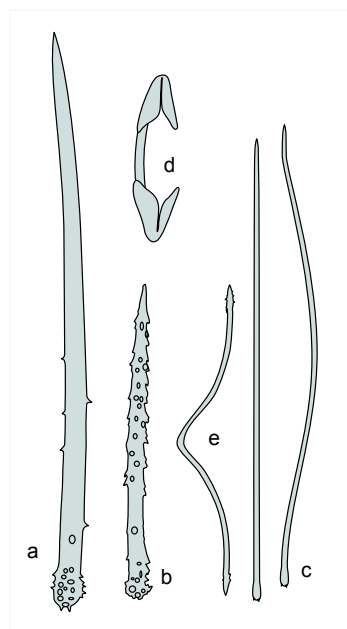

Source B.E. Picton. Editors D. Moss, B.E. Picton.

***Desmacidon fruticosum* (Montagu, 1818:112)**

Family	DESMACIDIDAE
Synonyms	None in common use.
Form	Massive-lobose; substantial growths often with massive tubular processes. The processes are simple or coalescent, often fusing at the bases and so resembling malformed, hand-like structures. Sometimes the thicker branches have a longitudinal groove in one side (? is this a common feature?).
Photographs	Scilly Isles. (K. Hiscock)
Colour	Yellow to orange. Are there any other colours?
Smell	None.



Slime	Exudes large amounts of slime when removed from the water.
Consistency	“Firm, compressible.”
Surface	Bristly.
Apertures	“Oscules are usually small, scattered and numerous”.
Contraction	
Skeleton	An irregular reticulation of thick multi-spicular fibres of tornotes. There is no special ectosomal skeleton nor any echinating spicules.
Spicules	The megascleres are tornotes (a), with oxete or mucronate ends, “184-236 $\mu$ m”. The microscleres are spatuliferous anchorate chelae (b) of two sizes, “32-49 $\mu$ m”, and sigmata (c) (of two sizes also?), “29-63 $\mu$ m”.
Voucher	MNHN Paris.
Habitat	? Usually on horizontal surfaces. “On mud, sand, gravel, rock, or broken shell.” Recent records are from 30m or greater depths.
Distribution	“British Isles; France; Spain.” Recent diving records from the Scilly Isles and Galway Bay.
Identity	More information is needed about this species. Anyone finding it is asked to record all possible information and to send it to the Editors. The skeletal net of tornote bundles with isochelae and sigmata in a massive yellow sponge which exudes slime is unlikely to be confused with other UK sponges.
Reference	Arndt, 1935, p.73.
Sources	J.D. Guiterman, S.M. Stone. <span style="float: right;">Editors J.D. Guiterman, D. Moss, B.E. Picton.</span>

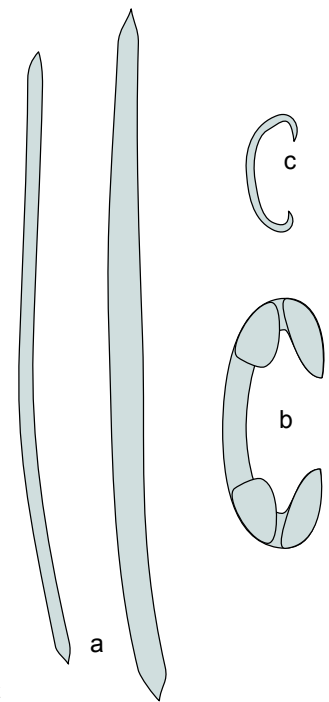

### ***Myxilla incrustans* (Johnston, 1842:122)**

Family	MYXILLIDAE subfamily MYXILLINAE
Synonyms	<i>Dendoryx incrustans</i> (Johnston, 1842:122) Gray, 1867:535
Form	A thick, spreading cushion, with raised ridges.
Photographs	Friar Is., Connemara. (B.E. Picton)
Colour	Usually sulphur yellow.
Smell	None.
Slime	Exudes a large amount of slime when taken out of the water.
Consistency	Moderately soft, elastic, crumbly.
Surface	Distinctive, consisting of numerous deep labyrinthine channels, across which run cobweb - like strands of tissue.
Apertures	Oscules are variable in size, numerous and scattered. They are obvious, circular and typically in lines along the raised ridges.
Contraction	Not noticeable.
Skeleton	A regular, isodictyal, reticulation with multi-spicular fibres, without echinating spicules. There is a surface layer of tornotes, tangential or at an angle to the surface. Spongin is scarce.



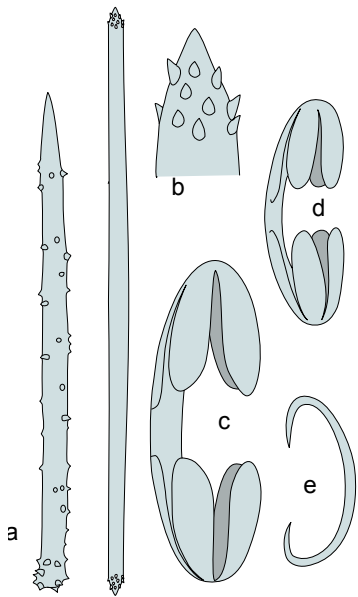

Spicules	The megascleres of the main skeleton are acanthostyles (a) 145-(170)-200µm. The ectosomal spicules are tornotes (b) with spear-shaped, microspined, ends, which are occasionally unequal 180-(190)-200µm. These lie in vertical brushes. Microscleres are spatuliferous anchorate chelae of two sizes, (c) 40µm and (d) 18µm, and sigmata (e) of two sizes, 33µm and 15µm.	
Voucher	BELUM : Mc564. Malin Beg, Donegal.	
Habitat	On rock in clear water. "LW to 400m on stones, shells, sand and mud."	
Distribution	"Arctic; Atlantic coasts of Europe south to Gibraltar; Mediterranean, etc." Recently known from many sites around the British Isles.	
Identity	This is probably the commonest massive, yellow sponge in exposed sites on vertical or clean rock. Initially identification needs to be checked with a microscope. Having checked that it is <i>Myxilla</i> (with a network of acanthostyles, without echinating spicules, accompanied by spatuliferous anchorate isochelae, and with tornotes at the surface), it is necessary to examine the tornote ends (b) with a microscope lens of good resolution (x40 objective is adequate). A number of spicules may have to be examined before it can be decided unambiguously which type is present.	
Breeding	Embryos are commonly found in specimens of <i>M. incrustans</i> during the months of August and September. These are globular, measuring 0.3mm to 0.5 mm (largest diameter).	
References	Arndt, 1935, p.58. Hiscock, Stone and George, 1983[1984], p.27.	
Sources	J.D. Guiterman, S.M. Stone. Editors J.D. Guiterman, D. Moss, B.E. Picton.	

### ***Myxilla fimbriata* (Bowerbank, 1864:251)\***

Family MYXILLIDAE, subfamily MYXILLINAE.

Synonyms *Isodictya fimbriata* Bwk. 1864:251, *Isodictya lurida* Bwk. 1866:336.

Form Cushion usually 6-7mm thick; can be 30mm thick. Found as distinct specimens 2-5cm across, with an irregular outline. The specimens are rounded in cross section with steep sides.

Photographs 1. Keem Bay, Achill Island, Mayo.

Colour Bright orange in surface layers, yellow in deeper layers. Specimens from less clear water conditions may be beige in colour. The sponge goes black or brown in alcohol, staining the label, but may fade to a dirty, pale brown.

Smell Slight.

Slime None.

Consistency Quite firm, tears easily. "Resilient."



Surface	Not 'open' as in <i>M. incrustans</i> though underlying porous areas are clearly visible through transparent 'skin'. "Slightly hispid", smooth to touch.
Apertures	The oscules are small, with slightly raised transparent rims. They are placed towards the central, thickest parts of the sponge, or raised on ridges. There are no oscular channels.
Contraction	Slight.
Skeleton	The reticulation of multispicular fibres is less regular and isodictyal than in other <i>Myxilla</i> spp. There are no echinating spicules associated with these fibres. Special ectosomal spicules (tornotes) are present. Spongin is scarce.
Spicules	The megascleres of the main skeleton are long, sparsely-spined acanthostyles (a) 265-(300)-350µm in length. The surface tornotes (b) measure 202-(290)-325µm in length and have abruptly terminating ends, ending in a short point, often mucronate. The ends are sometimes slightly unequal lying in vertical brushes. Different development stages of tornote ends can be present in any one specimen, making recognition difficult. However the broad pattern should conform to the diagram given here. Microscleres are spatuliferous anchorate chelae, of two sizes (c) 60µm and (d) 27µm. Sigmata are infrequent or absent, thin, and easily overlooked.
Voucher	BELUM : Mc575. Skird Rocks, Galway.
Habitat	On rock in lower infralittoral and upper circalittoral.
Distribution	"Arctic; Faroes; Norway; Sweden; British Isles!" Known recently from various sites on the W and SE of Ireland, where this sponge is a characteristic circalittoral species in sites exposed to the Atlantic. Also Rathlin Is., Co. Antrim; St. Abbs; Coll; Lewis.
Identity	Superficially there might be confusion with <i>Amphilectus fucorum</i> but there are distinct spicule differences. The blackening of the sponge in alcohol is rapid and striking, and this combined with a lack of slime in what is otherwise a typical Myxillid skeleton makes this species distinctive from other Myxillid species such as <i>M. rosacea</i> and <i>M. incrustans</i> . If there are echinating spicules and the chelae are arcuate, the specimen belongs to a different genus, e.g. <i>Ectyodoryx</i> . Note from BEP: "There is definitely another form/species of this sponge with distinct oscular channels, which goes dark brown in alcohol, doesn't slime and has a similar spiculation. However the acanthostyles in this form are much thicker."
References	Arndt, 1935, p.58. Bowerbank 1866, p.337; 1874, p.147.
Sources	B.E. Picton, S.M. Stone, R. Earll. Editors R. Earll, D. Moss, B.E. Picton.

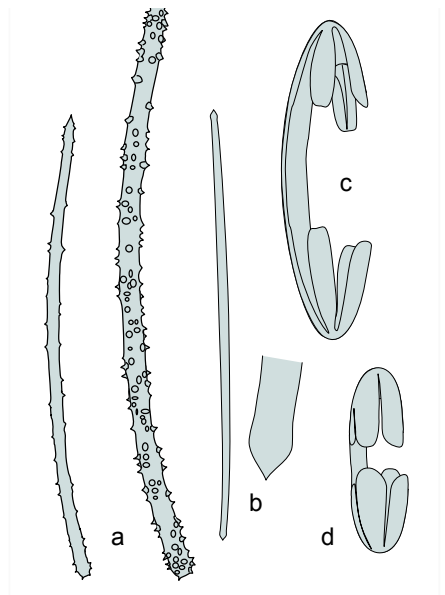

### *Myxilla rosacea* (Lieberkuhn, 1859:521)\*

Family	MYXILLIDAE
Synonyms	None in common use.
Form	Cushions 0.5 - 1cm thick, forming patches up to 15cm across; becoming branched - erect in deeper waters. It may form upright growths around hydroid stems.
Photographs	BELUM: Mc1847. E. Tearaght Is., Blaskets, Kerry.
Colour	Yellow, or "dirty rose-red", or brownish orange when alive.
Smell	None.
Slime.	Considerable quantities are exuded.
Consistency	"Loose, somewhat crumbly. Elastic."



Surface	A loose, porous appearance, similar to that of <i>M. incrustans</i> . Slightly hispid.
Apertures	The oscules are scattered across the animal, and have raised edges. Exhalant channels run up to the oscules; “not apparent when preserved”.
Contraction	None.
Skeleton	The main skeleton is a reticulation (sub-isodictyal) of acanthostyles in multispicular fibres, with no echinating spicules. Special ectosomal spicules (tornotes) are present. Spongin is scarce.
Spicules	The megascleres of the main skeleton are acanthostyles (a) whose spines are few but strong, and present throughout the length of the spicule 140-(145)-152µm . The surface tornotes (b) bear three or four small spines at the ends and are 140-(150)-160µm long, and lie in vertical brushes at the surface. The microscleres are spatuliferous anchorate chelae (c) of two sizes (12-15µm, 20-25µm), which are present throughout the sponge, together with small sigmata (d), ca. 17-35µm.
Distribution	“Arctic; Faroes; British Isles; Atlantic coasts of France and Spain; Mediterranean; etc.” Widely distributed and common on the western coasts of the British Isles.
Identity	Superficially it can be very similar to <i>M. incrustans</i> , but it does not seem to form the raised, oscule bearing ridges of the latter species (?). Examination of the tornote ends at high power is necessary to confirm identification. It is possible that more than one species is involved here.
Voucher	BELUM : Mc1010. St Kilda.
Habitat	At exposed sites, on rock, from the infralittoral “down to 300 m, and on shells”. Also found on the shore.
References	Arndt, 1935, p.59 Hiscock, Stone and George, 1983[1984], p.27.
Sources	B.E. Picton, S.M. Stone.                      Editors D. Moss, B.E. Picton.

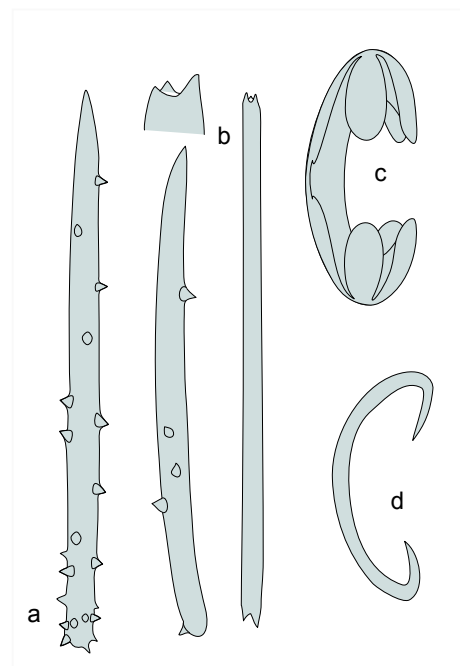

### *Myxilla cf. rosacea*

Family	MYXILLIDAE
Synonyms	none
Form	Massive-lobate, sometimes with ‘tassels’, very irregular.
Photographs	Limestone, Strangford Lough, Down. (B.E. Picton)
Colour	Grey/white to pink/pale orange.
Smell	None.
Consistency	Very soft and slimy (“wet brain”).
Surface	The surface is irregular, almost conulate, being raised into many bumps. There is a thin transparent surface membrane. Typical Myxillid pores are absent. There are denser white patches where spicules are more abundant.
Apertures	Oscules are scattered, and somewhat irregular in shape. They are large but not numerous or conspicuous, with raised transparent edges.
Contraction	The surface collapses on removal from water, but there is no true contraction.



Skeleton	The principal skeleton consists of a regular reticulation of acanthostyles. Tornotes are present in the surface. Chelae and sigmata are present throughout.	
Spicules	Acanthostyles (a) 170-(195)-210µm, more densely spined than those of <i>M. rosacea</i> , tornotes (b) 170-(180)-210µm, with microspined ends. Chelae (c) are about 35-40µm and 15-20µm; abundant sigmata (d), ca.25µm and 15µm, are present.	
Voucher	BELUM : Mc229. Strangford Lough, Down.	
Habitat	Found in sheltered areas with reasonable current (1/2-1 knot) on <i>Modiolus modiolus</i> ; almost free on mud; on hydroids and rock.	
Distribution	So far known only from Strangford Lough between 20 and 30m.	
Identity	Appearance is quite unlike other Myxillids. Spiculation is similar to <i>M. rosacea</i> ( <i>q.v.</i> ) but the acanthostyles are larger and more densely spined.	
Sources	B.E. Picton, S.M. Stone.	Editors D. Moss, B.E. Picton.

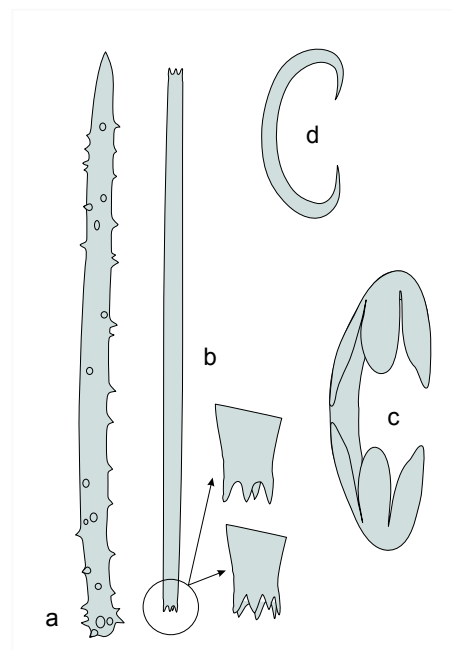

### *Iophon hyndmani* (Bowerbank, 1858:302)

Family	MYXILLIDAE
Synonyms	In recent literature it is treated as a synonym of <i>Iophon ingalli</i> (Bwk, 1866:258). As it belongs to a taxonomically difficult group, it may be best, at the moment, for us to treat it as <i>I. hyndmani</i> . Also cited as <i>Pocillon hyndmani</i> (Bwk,1858:302) Topsent 1894:8.
Form	Thin sheet or cushion, developing into branching-repent form with anastomosing branches, 3 - 4mm diameter.
Photographs	1. Glannafeen Cliff, L. Hyne, Cork (on algae). (B.E. Picton)

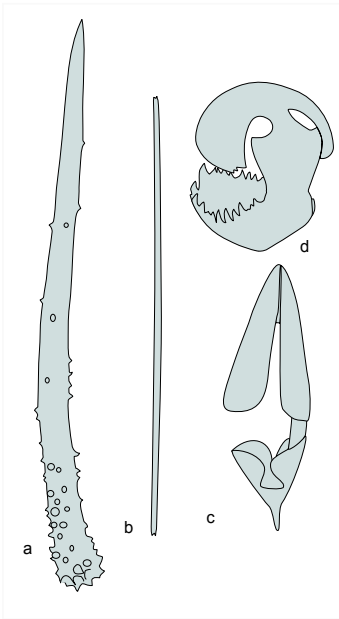

Colour	Pale yellow, purple only when preserved. The colour change on preservation in alcohol to brown is distinctive, paper labels are stained brown.	
Smell	? None, not strong?	
Consistency	Moderately soft, branches have no axial skeletal structure and apparently only develop fully in fairly sheltered conditions. Friable and not easy to section.	
Surface	“Wrinkled or thrown into prominent folds.” Initially smooth sheets, developing into fistular outgrowths, and eventually anastomosing branches.	
Apertures	Oscules “small, scattered”, not obvious.	
Contraction	None.	
Skeleton	A plumo-reticulation of loose, multispicular fibres, with echinating spicules. There is a surface layer of strongyles (lying tangentially or in vertical brushes). Spongin is scarce.	
Spicules	Megascleres of the main skeleton are acanthostyles (a), which are smooth in the distal (i.e. further from the base) half, 200-(225)-250µm. The echinating acanthostyles are entirely spined and are 130-(155)-175µm “110µm” long. The ectosomal spicules are very thin tornotes (b), with strongylote ends which bear crowns of a few spines, ca. 135-(170)-195µm. Microscleres are palmate anisochelae (c), 13-20µm long, and bipocilles with saucer shaped ends (d), 9-15µm long.	
Voucher	BELUM : Mc138. Strangford Lough, Down.	
Habitat	On shells such as <i>Modiolus modiolus</i> , <i>Chlamys varia</i> , and <i>Aequipecten opercularis</i> ; on rocks, in localities sheltered from wave action, with no or slight tidal action. “On hydroids, other sponges, coralline algae, nullipores, fucoids, etc.”	
Distribution	“Norway; British Isles; France; Mediterranean.” Recent voucher specimens from Strangford Lough (the original type specimen was collected from Strangford Lough by Hyndman). Also Mulroy Bay; Lough Hyne; Rathlin Is.; Kilkieran Bay; Skomer; Loch Sunart, Loch Fyne. Common.	
Identity	Difficult to identify with confidence when encrusting, but when well developed the characteristic branching combined with the colour are fairly distinctive. It belongs to a very difficult group taxonomically, so all identifications must be treated as provisional - see also <i>Iophon ingalli</i> , <i>Iophon pattersoni</i> (Bwk., 1866:255), etc. This description is based partly on voucher material collected from the type locality, Strangford Lough, in 1980.	
Reference	Bowerbank, 1866, p266-268. Arndt, 1935, p.61.	
Sources	B.E. Picton, S.M. Stone.                      Editors R. Earll, D. Moss, B.E. Picton.	

***Iophon nigricans* (Bowerbank, 1858:297)**

Family MYXILLIDAE

Synonyms *Menyllus nigricans* (Bwk., 1858:297) Gray 1867:533

Form Ascending finger-like growths with broader bases, cushions, massive-lobose.

Photographs 1. Sligneach Mor, L. Sunart, west Scotland. (B.E. Picton)  
2. Boreray, St Kilda. (B.E. Picton)

Colour Off-white, grey, through bright yellow to bright orange, blackening on contact with air and on preservation.

Smell None.

Consistency Fairly soft and crumbly.

Surface Irregular, with raised areas of denser appearance supported by the underlying skeleton, with a transparent surface membrane between these ridges.

Apertures Oscules are slightly raised, with transparent rims, and are found along the edges of the fingers and on raised ridges of lobed form.

Contraction Oscules disappear and surface membrane collapses on removal from water.

Skeleton A fairly regular mesh of acanthostyles which is reminiscent of *Myxilla* spp. There are dense bundles of tornotes lying tangentially and at an angle to the surface. Bipocilles and anisochelae are scattered throughout the body with small anisochelae more abundant at the surface.Spicules Acanthostyles (a) stout, typically 220-(240)-260 $\mu$ m long; tornotes (b) with swollen microspined ends, stout, 240-(245)-250 $\mu$ m long. Anisochelae (c) ca. 26 $\mu$ m and 10 $\mu$ m. Bipocilles (d) small ca. 7.5 $\mu$ m.

Voucher BELUM : Mc1182. Maidens, Antrim.

Habitat Found in sheltered or moderately exposed sites, with moderate to strong tidal streams. On rocks, boulders, steep rockfaces and shells. Circalittoral. Common on brachiopod valves in Firth of Lorne.

Distribution Common and widespread in the English Channel, Ireland and W. Scotland.

Identity The blackening on death is very noticeable, and the bipocilles and tornotes with microspined ends are characteristic. Larger specimens may resemble *Myxilla incrustans* or *Myxilla rosacea* superficially.

Reference Bowerbank, 1866, p266-268.

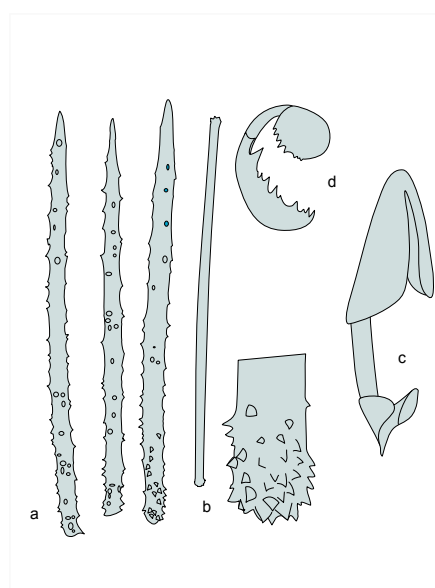
Sources B.E. Picton, S.M. Stone.  
B.E. Picton.

Editors D. Moss,

***Hymedesmia brondstedi* Burton, 1930:497**

Family	HYMEDESMIIDAE	
Synonyms	<i>Dendoryx dujardini</i> (Bwk., 1866:224) Topsent, 1888:146, <i>Stylopus dujardini</i> (Bwk., 1866) Levinsen, 1887:512, nec <i>Halisarca dujardini</i> Johnston, 1842.	
Form	A thin somewhat slimy sheet on rocks or shells. Patches up to 15cm diameter have been seen, 2-3mm thick.	
Photographs	Great Saltee Island, Wexford. (B.E. Picton)	
Colour	Usually grey-brown. Also reported to be sometimes pale or deep “yellow, orange-yellow, violet or bright red”.	
Consistency	Thin and fragile, difficult to remove as a sheet or to section.	
Surface	With pores scattered fairly evenly all over. Smooth. Obvious excurrent channels may be present.	
Smell	?None	
Apertures	Oscules scattered over surface of sponge, with conical raised edges.	
Contraction	Some.	
Skeleton	In all <i>Hymedesmia</i> spp. there are acanthostyles with their heads standing on the substrate and their shafts sticking up through the sponge. In this species they are short and may easily be missed. The rest of the skeleton consists of flexuous columns or fibres of many parallel smooth tornotes with tylote ends which fan out at the surface. Skeleton is Hymedesmoid, i.e. permanently encrusting with both principal and secondary endosomal spicules orientated perpendicularly to the substrate.	
Spicules	The principal megascleres are acanthostyles (a), entirely spined, but especially thickly on the heads, 110-135µm. Accessory megascleres are tornotes (b) 180-(190)-200µm, with strongylote to subtylote ends, sometimes with unequal ends, rarely polytylote. This description, although technically accurate may be misleading in practice as the acanthostyles are often few in number and easily missed. Thus the main body of the sponge usually appears to consist of bundles of tornotes. Microscleres are absent.	
Voucher	BELUM : Mc164. Strangford Lough, Down.	
Habitat	Very common, e.g. on valves of <i>Aequipecten opercularis</i> and other shells; rock surfaces especially in the kelp zone.	
Distribution	“Arctic, Atlantic coast of Europe, Mediterranean” Known recently from E. Scotland, St. Abbs; W. Scotland, Tiree; Strangford Lough; Lough Hyne, Co. Cork; Saltee Is., Co. Wexford.	
Identity	The appearance seems to be fairly characteristic, but caution is needed. A Hymedesmoid skeleton with no microscleres is suggestive, but other <i>Hymedesmia</i> spp. from Britain which lack microscleres include <i>Halichondria hibernica</i> Stephens 1916 : 237. <i>Hymedesmia radiata</i> is actually a species of <i>Eurypon</i> . BEP has collected several specimens with spiculation and skeleton more or less as described here, but with different external appearances, and given the large number of <i>Hymedesmia</i> spp. already described it is quite possible that more species exist which lack chelae or sigmata. <i>Hymedesmia</i> species which lack microscleres are frequently placed in the genus <i>Stylopus</i> and several other species are described in the continental literature.	
References	Arndt, 1935, p.64, as <i>Stylopus dujardini</i> . Van Soest, 1987, p.20, as <i>Hymedesmia coriacea</i> .	
Sources	B.E. Picton, S.M. Stone.	Editors D. Moss, B.E. Picton.

***Hymedesmia jecusculum* Bowerbank, 1882: 56.**

Family	HYMEDESMIIDAE
Synonyms	<i>Hymeniacidon jecusculum</i> Bowerbank, 1866: 198
Form	Thin sheets, up to 10cms across, but smaller typically.
Photographs	BELUM: Mc1309. Loch Duich, W. Scotland. (B.E. Picton)
Colour	Deep orange or red.
Smell	None.
Slime	None.
Consistency	Soft.
Surface	Smooth, with subsurface exhalent canals visible. Densely covered with oval pore areas.



Apertures	Oscules may not be apparent. Pores in oval pore-sieve areas with smooth tissue between.
Contraction	Hard to determine because of thinness of sheets.
Skeleton	Hymedesmoid, with large primary acanthostyles and also smaller acanthostyles echinating the substrate. The rest of the skeleton consists of flexuous columns or fibres of many parallel tornotes, which fan out to run parallel with the surface. Arcuate isochelae reinforce the ectosome.

Spicules Primary acanthostyles (a) measure  $\mu\text{m}$  in length by ca.  $\mu\text{m}$  in width. The head is thickly set with spines, whilst small, rather scattered, spines extend along the shaft but are much less frequent in the distal half. There is usually an abrupt curvature just above the head, the rest of the shaft being straight. The smaller acanthostyles (b) measure  $\mu\text{m}$  in length by  $\mu\text{m}$  in width. They are straight or very slightly curved, and conspicuously spined along the whole length. The spines on the head are fairly long, those on the shaft recurved. The tornotes (c) are slightly fusiform, thin, measuring  $\mu\text{m}$  in length, by  $\mu\text{m}$  in width. They are symmetrical, pointed at both ends. Microscleres are arcuate isochelae (d), ca.  $\mu\text{m}$  in length.

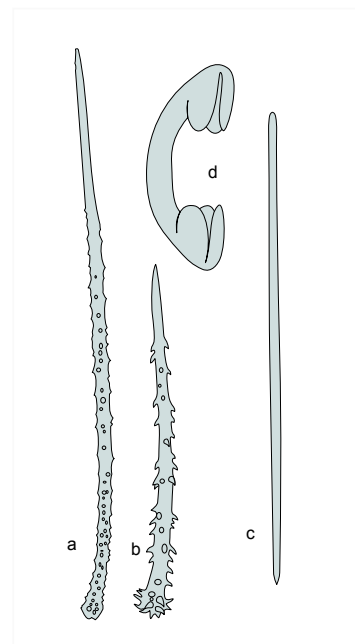

Voucher	BELUM : Mc1309. Loch Duich, Scotland
Habitat	On bedrock and boulders, usually in deep water below 25m depth, but originally described from a cave in the intertidal zone. On horizontal rock in clear water.
Distribution	West coast of Ireland and Scotland, this is the commonest <i>Hymedesmia</i> species in diving range in these areas.
Identity	External appearance is not particularly helpful, but the pore sieves and thin sheet may suggest a hymedesmid sponge. The spicule complement and sizes are distinct from the other <i>Hymedesmia</i> species in this Guide, but there are many other <i>Hymedesmia</i> species and the complex is currently ill-understood.

## References

Sources	B.E. Picton	Draft 1 3/90
---------	-------------	--------------



***Hymedesmia pansa* Bowerbank, 1882: 56.**

Family HYMEDESMIIDAE

Synonyms None.

Form Thin sheets, up to 3cms across, but smaller typically.

Photographs Gurraig Sound, Kilkieran Bay, Galway. 12cms. The sponge in the middle is *Hemimycale columella*. (B.E. Picton)

Colour Consistently pale yellow. “Yellow, or yellowish orange” (in the Mediterranean). “Deep orange, rarely red”. (Amber yellow when dry, pale pink in spirit).

Smell None.

Slime None.

Consistency Soft.

Surface Smooth, with subsurface exhalant canals visible. Densely covered with oval pore areas.

Apertures Oscules may not be apparent. Pores in oval pore areas with smooth tissue between. “Oscules dispersed, simple”.

Contraction Hard to determine because of thinness of sheets.

Skeleton Hymedesmoid, with large primary acanthostyles and also smaller acanthostyles echinating the substrate. The rest of the skeleton consists of flexuous columns or fibres of many parallel (subtylo)tornotes, which fan out to run parallel with the surface. Arcuate isochelae reinforce the ectosome.

Spicules Primary acanthostyles (a) measure 220-(235)-250 $\mu\text{m}$  “155-300 $\mu\text{m}$ ” in length by ca. 5-10 $\mu\text{m}$  in width (ca. 110-170 x 3-10 $\mu\text{m}$  in the Azores, according to Boury-Esnault & Lopes). They have a slightly curved shaft and the head is thickly set with spines, whilst small, rather scattered, spines extend along the shaft but are much less frequent in the distal half. The smaller acanthostyles (b) measure 95-(103)-110 $\mu\text{m}$  “60-120 $\mu\text{m}$ ” in length by 4-7 $\mu\text{m}$  in width. They are straight or very slightly curved, and conspicuously spined along the whole length. The spines on the head are fairly long, those on the shaft recurved. The tornotes (c) are very slender, straight, measuring 215-(237)-260 $\mu\text{m}$  “180-260 $\mu\text{m}$ ” in length, by 2-3 $\mu\text{m}$  in width. They are strongylote to subtylote, one end being rounded and sometimes very slightly swollen, the other tapering to a fine point, slightly fusiform; indeed they could equally be described as styles. Microscleres are arcuate isochelae (d), ca. 16-19 $\mu\text{m}$  in length (11-22 $\mu\text{m}$  in specimens from the Azores) with a less strongly curved shaft than in most *Hymedesmia* species.

Voucher BELUM : Mc1576. Rathlin Island, Antrim.

Habitat On rock, stones and bivalve shells, to 300m. Reported on algae and sponges in the Mediterranean. On horizontal rock in clear water.

Distribution Channel (Roscoff), west coast of England, Mediterranean, Azores.

Identity External appearance is not particularly helpful, but the pore sieves and thin sheet may suggest a hymedesmid sponge. The spicule complement and sizes are distinct from the other two *Hymedesmia* in this Guide, but there are many other *Hymedesmia* species and the complex is currently ill-understood.References Arndt, 1935, p.67.  
Boury-Esnault and Lopes, 1985, p.187.  
Stephens, 1921, p.36.  
Topsent, 1925, p.672; 1936, p.29.

Sources G. Ackers (D. Moss, B.E. Picton).

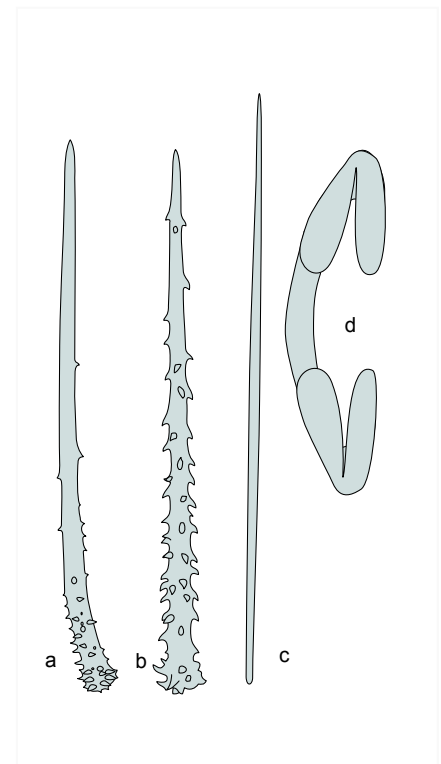

Editors D. Moss, B.E. Picton.

Draft 1 3/90

***Hymedesmia paupertas* (Bowerbank, 1866: 223-224)**

Family HYMEDESMIIDAE

Synonyms *Anchinoe paupertas sensu* Stephens, 1921:35. NB. the species known as *Anchinoe paupertas* in the Mediterranean is a species of *Anchinoe* (*Phorbos*) and is not this species.

Form Small thin sheets usually covering areas only 1 or 2cm in diameter, very irregular in outline, giving the appearance of several separate patches.

Photographs Calve Island, Sound of Mull, west Scotland. (B.E. Picton)

Colour Bright blue or green - distinctly unusual.

Smell None

Consistency Difficult to determine.

Surface With small pore sieves, similar to *Hemimycale columella*. This appears to be characteristic of a group of *Hymedesmia* spp. which may all be related more closely to *Phorbos* and *Hemimycale* than to other *Hymedesmia* species.

Apertures Oscules with converging excurrent channels and transparent, slightly raised rims, few in number and towards the centre of patches.

Contraction Difficult to determine.

Skeleton A basal layer of acanthostyles of two sizes with their heads on the substrate. The longer ones have smooth shafts, the shorter are entirely spined. Fibres of parallel tornotes, with slightly different ends, run up through the body to the surface. The surface layer of chelae is especially packed in the pore areas.

Spicules Acanthostyles (a) of two types are present: long ones with more or less smooth shafts, 360-(400)-420µm long; and short entirely spined ones, 130-(150)-155µm long. There are also tornotes (c), length 225-(263)-275µm, and arcuate isochelae (d), 25-32µm, with particularly broad shafts when viewed face-on, and very arcuate from the side.

Occasional aberrant spicules (b) apparently derived from the larger acanthostyles, may be present.

Voucher BELUM : Mc513. Lunga, Firth of Lorne, Hebrides.

Habitat So far recorded from deep rocky areas, sheltered or with moderate exposure. A circalittoral species, found on cliffs in W. Scotland, and on limestone ridges in western Ireland.

Distribution Known recently from Bill's Rocks, Achill Is., Co. Mayo; Rathlin O'Birne Is., Co. Donegal; St. John's Pt., Co. Donegal; west coast of Scotland.

Identity The combination of pore sieves and bright blue or green colour seems to be characteristic of this species, as is the **shape of the chelae** and tornotes. Many *Hymedesmia* species exist, whose live appearance is currently unknown. *Terpios gelatinosa* (q.v.) is a blue sponge found in the littoral zone.

References Stephens, 1921, p.35.

Source B.E. Picton.

Editors D. Moss, B.E. Picton.

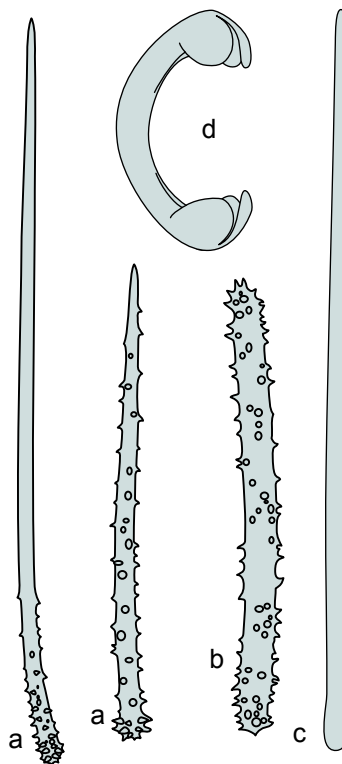

***Spanioplion armaturum* (Bowerbank, 1866: 183)**

Family	HYMEDESMIIDAE	
Synonyms	<i>Hymeniacion armatura</i> Bowerbank, 1866: 183, <i>Hymedesmia stephensi</i> Burton, 1930: 494.	
Form	Moderately thin sheets, up to 7cm across, to cushions 1cm thick.	
Photographs	Long Sheelagh, Strangford Lough, Down. (B.E. Picton)	
Colour	Grey (dark red brown when dried).	
Smell	None	
Slime	“Slimy”.	
Consistency	Soft.	
Surface	Smooth, with obvious exhalent canals which become deep grooves on removal from the water. “Uneven, hispid, in places slightly conulose”.	
Apertures	Oscules few in number, sometimes scattered, or at the edge of specimens growing on shells. Ostia not apparent.	
Contraction	Considerable contraction and collapse of the oscular channels occurs on removal from water.	
Skeleton	The ectosome consists of tangentially arranged strongyles, sometimes collected into bundles. In the choanosome there are styles loosely arranged into tracts, together with many scattered small acanthostyles.	
Spicules	There are three types of megascleres. The styles (a) measure 235-(250)-260µm “220-250µm” by 2-8µm, and are slightly curved. The heads of some show tylote and/or mucronate tendencies, and very sparse spines may occur towards the head end. Strongyles (b) measure 195-(200)-205µm by 1-8µm, and sometimes possess variably and unequally dilated ends. The acanthostyles (c) are 55-(72)-90µm “40-65µm” by 1-5µm, and they are characteristically small and thin, with only slightly swollen heads, and very short points. They are weakly, but entirely, spined. Microscleres are absent.	
Voucher	BELUM : Mc211. Strangford Lough, Down.	
Habitat	On stones, bivalve shells, and under boulder/bedrock overhangs. Found both in very sheltered conditions in sites like Strangford Lough, in <i>Modiolus</i> communities, and on very exposed bedrock, eg. at St. Kilda. In the Mediterranean, reported on bryozoans, other sponges, and plant debris. Shore to 50m.	
Distribution	N. Atlantic, Mediterranean. Known recently from Lough Hyne, Strangford Lough, several localities in the Channel, St. Kilda.	
Identity	The size and shape of the acanthostyles, and the variability of the other two megascleres, are characteristic on microscopic examination. This sponge typically covers shells of <i>Chlamys varia</i> and develops into thick cushions completely covering the shell, with a single oscule at the outer edge. It is frequently perforated by many tubes of polychaete worms.	
References	Arndt, 1935, p.82. Bowerbank, 1866, p.183; 1874, p.88. Burton, 1930, p.494. Topsent, 1928, p.236.	
Source	G. Ackers (B.E. Picton).	Editors D. Moss, B.E. Picton. Draft 1 2/90

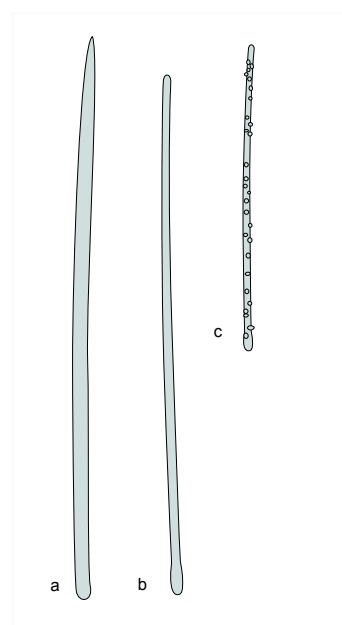

***Hemimycale columella* (Bowerbank, 1874:243)**

Family HYMEDESMIIDAE

Synonyms *Stylotella columella* (Bwk., 1874) Topsent, 1894:8.

Form Thin sheet to cushion.

Photographs South Haven, Skomer Island, south Wales. (B.E. Picton)

Colour Bright red to pale orange or pink. The darker coloured depressions have lighter coloured rims.

Smell None.

Consistency Moderately soft when alive and undisturbed.

Surface Slippery, smooth. The surface is covered in shallow, circular, non-contractile depressions of varying diameters. The rims are usually lighter coloured than the rest of the body. The depressions contain the inhalent pores, and are covered by a fine, gauze-like, mesh. These depressions become less obvious when the sponge is left out of the water.



Apertures Oscules occur infrequently. They are located on top of special papillae which contract if disturbed and are lost on preservation.

Contraction Noticeable. In particular the oscules cease to be obvious when the sponge is removed from the water. "Cushion tends to curl up at the edges when preserved."

Skeleton Plumose. The main skeleton is of loose fibres of spicules, which run vertically up to the surface, branching and anastomosing. There is no special ectosomal skeleton.

Spicules The megascleres are anisostrongyles (i.e. strongyles with unequal ends), sometimes modified to styles to subtylostyles. These measure 300-(330)-345µm in length by 6-8µm in width. There are no microscleres.

Voucher BELUM : Mc1258. Rathlin Is, Antrim.

Habitat A common species, found on clean rock, "stones or shingle". It attains its optimal development in the kelp zone. Apparently not found in harbours.

Distribution "Arctic; British Isles; France; Mediterranean." Not North Sea coasts. Northern limit probably is the west coast of Scotland.

Identity Provided the colour is red-pink and the rims of the depressions are of a lighter colour, the identification stands a good chance of being correct, but in case of doubt microscopic examination is essential. Several other genera contain species which have depressions with rims which are the same colour as the general surface (see e.g. *Phorbastictius* and *Hymedesmia paupertas* in this Guide).References Arndt, 1935, p.55.  
Forster, 1955, p.533.  
Hiscock, Stone and George, 1983[1984], p.26.

Sources S.M. Stone. Editors J.D. Guiterman, D. Moss, B.E. Picton.

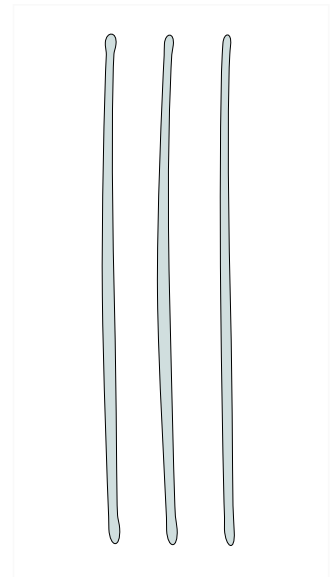

***Phorbas fictitius* (Bowerbank, 1866:124)**

Family	HYMEDESMIIDAE	
Synonyms	<i>Anchinoe fictitius</i> (Bowerbank, 1866:124) Stephens, 1921:45, <i>Plumohalichondria fictitia</i> (Bowerbank, 1866:124) Hanitsch, 1894:195, <i>Microciona fictitia</i> Bowerbank, 1866:124.	
Form	Thin sheets to cushions, up to 14mm thick when contracted. Forms patches up to 30cm across.	
Photographs	Gob na H'Airde, St Kilda. (B.E. Picton)	
Colour	Variable. Grey, pale orange pink, to deep red. This is a species where the amount of pigment present generally reflects prevailing water clarity and illumination levels. On the west coast of Ireland it is normally bright red, while in turbid water in Strangford Lough it is pale pink. In alcohol the sponge and alcohol go the same colour, "a greyish yellow".	
Smell	Present, but not strong.	
Consistency	Firm, "compressible".	
Surface	Smooth to slippery, with circular depressions containing inhalent pore sieves similar to those in <i>Hemimycale columella</i> , but the rims are the same colour as the rest of the sponge. Unlike <i>Hemimycale</i> the inhalent depressions contract in disturbed and collected specimens. The depressions are smaller at ca. 1mm (max 2mm) than in <i>Hemimycale</i> when out of the water, and are more uniform in diameter in any given specimen.	
Apertures	Oscules are distinct, with raised translucent rims; raised oscular channels may be visible whilst <i>in situ</i> but disappear on preservation. Regularly distributed.	
Contraction	Distinct: 25 - 50%.	
Skeleton	Plumose. Main skeleton of ascending multispicular fibres of tornotes echinated and almost concealed by acanthostyles. Tornotes also form the ectosomal skeleton. Chelae are present, abundant in the ectosomal region. Spongin does not encase the spicules in the ascending fibres as much as in the Crellinae (q.v.)	
Spicules	Megascleres are tornotes with dissimilar, oxecote, ends (a), 310-(330)-350µm. Acanthostyles are of two sizes, the larger (b) are basally spined, 330-(430)-490µm and the smaller (c) entirely spined, 130-(155)-195µm. Microscleres are arcuate isochelae (d), 18-25µm.	
Voucher	BELUM : Mc468. Tiree, Hebrides.	
Habitat	In exposed or tide swept areas on rock. Most often recorded in the infralittoral zone, on gully walls. "Can be locally abundant, in the littoral and to 19m; on hydroids, oyster shells and under stones."	
Distribution	"British Isles; France; Spain, Mediterranean." Known recently from Strangford Lough; Tiree; Western Ireland; Saltee Is., Co. Wexford; Isle of Man; Lley peninsula. A fairly common species.	
Identity	This species has been confused <i>in situ</i> with <i>Hemimycale columella</i> but its raised oscular rims, conspicuous oscules and the lack of white rims to the uniformly-sized depressions make it quite easy to distinguish from <i>Hemimycale</i> . A number of Phorbasinid and Hymedesmid species could be confused superficially with this species, so the spiculation and skeleton must be checked for positive identification. Both spiculation and colour are similar to <i>Hymedesmia jecusculum</i> (q.v.), but this species is permanently a thin sheet. <i>Phorbas</i> is distinguished from <i>Crella</i> spp. by having echinating spicules on the ascending fibres, and ectosomal spicules of tornotes rather than acanthostyles.	
Reference	Stephens, 1921, p.45 as <i>Anchinoe fictitius</i> .	
Sources	B.E. Picton, S.M. Stone.	Editors R. Earll, D. Moss, B.E. Picton.

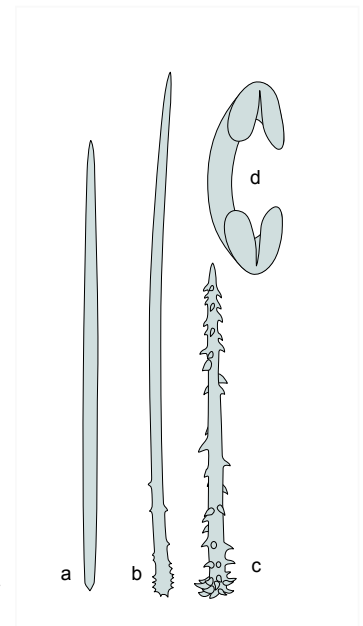

***Phorbas plumosum* (Montagu, 1818:116)**

Family HYMEDESMIIDAE

Synonyms *Plumohalichondria plumosa* (Montagu, 1818) Carter, 1885:355, *Microciona plumosa* (Montagu, 1818) Parfitt, 1868:15, *Pronax plumosa* (Montagu, 1818) Gray, 1867:536, *Stylostichon plumosum* auctt.

Form A thin cushion, typically 5mm to 1cm thick, spreading in patches of diameter typically ca. 6cm. It may become massive-lobose in sheltered locations.

Photographs BELUM: Mc525. Saltee Islands, Wexford. (B.E. Picton)

Colour Variable: "scarlet", orange to dirty violet-brown.

Smell A strong smell, variously described as like iodine or 'garlic on breath'; or (?) 'like *Amphilectus*'.

Consistency Somewhat crumbly, compressible and fairly resilient.

Surface More or less smooth or somewhat tuberculate or "conulate", with transparent tissue between the tubercles.

Contraction Slight. (There is a tendency to 'curl up' on removal from the water).

Apertures Oscules "small", scattered, "numerous" and obvious; they may be in groups. Excurrent channels are present.

Skeleton A plumose skeleton of ascending multi-spicular fibres of acanthostyles, echinated by smaller acanthostyles. There is a well developed ectosomal skeleton of tornotes arranged in vertical brushes. Spongin is scarce.

Spicules Megascleres of the main skeleton are large acanthostyles (a), 180-(200)-240µm, sparsely spined and echinated by smaller acanthostyles (b), 80-(110)-140µm, which are densely and entirely spined. The ectosomal tornotes (c) have oxete ends and are 160-(170)-185µm in length. The microscleres are arcuate isochelae (d) of distinctive shape, small and fine, ca. 15µm.

Voucher BELUM : Mc525. Saltee Islands, Wexford.

Habitat Common. Typically found in shallow water - the kelp zone, especially in highly exposed sites, and in 'rapids' situations on upper surfaces of rocks. It may also occur in semi-sheltered situations with moderate current. "Littoral to 680m."

Distribution "Faroës; British Isles; Atlantic coasts of France and Spain; Portugal; etc." Recently known from Tiree, St Kilda, W. Scotland; Strangford Lough; Lough Hyne; Saltee Is., Co. Wexford; Co. Galway; N. and W. Cornwall; Anglesey; Sussex; Jersey.

Identity The smell and appearance are fairly characteristic, but there are several other species of *Phorbas* whose living characters are not known, as well as the others described here. The spicule complement with only one size of chela and no sigmata is characteristic of *P. plumosum*.

Reference Arndt, 1935, p. 80.

Sources B.E. Picton, S.M. Stone, (D. Moss). Editors D. Moss, B.E. Picton.

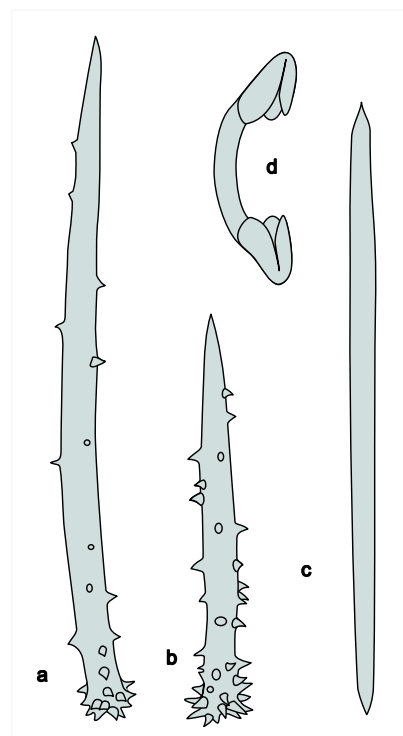

***Phorbas dives* (Topsent, 1891: 543)**

Family HYMEDESMIIDAE  
 Synonyms *Microciona dives* Topsent, 1891: 543, *Stylostichon dives* auctt.

Form Crust to cushions to about 1cm thick; spreading in patches to more than 1m across.

Photographs BELUM: Mc1374. Gabrielle Rock, Guernsey, Channel Isles. (B.E. Picton)

Colour Creamy to brownish or greenish yellow, orange.

Smell A slight 'spongy' or "fresh marine" smell.

Consistency Compressible, fairly resilient; breaks when bent through ca. 90°.

Surface More or less smooth with conspicuous broad subsurface channels converging on the oscules.

Contraction Slight.

Apertures Quite numerous, of moderate size.

Skeleton A plumose skeleton of ascending multispicular fibres of acanthostyles, with smaller accessory acanthostyles. Occasionally spicules at the end of the fibres penetrate the surface. Tornotes common in the surface, more or less perpendicular to it. Abundant sigmata in the endosomal tissues and chelae arcuatae, most abundant near the surface.

Spicules The megascleres of the main skeleton are acanthostyles (a), 180-(211)-275µm, sparsely spined especially away from the head. The auxiliary acanthostyles (b) are 60-(92)-110µm long, and relatively strongly spined. The ectosomal tornotes (c) are 132-(147)-155µm long. Microscleres are sigmata and arcuate isochelae. The sigmata (e) are usually in two size groups, ca. 15-18µm and 35-40µm - the latter are more numerous. The isochelae (d) are mostly of two size classes, ca. 13-15µm and ca. 20µm, with a few ca. 35µm and a very few ca. 8-10µm (the latter may be difficult to detect).

Habitat Vertical hard substrate faces, from shallow sublittoral (well-shaded and wave exposed) to 75m; on overhangs and under cobbles and boulders. Among *Cystoseira* (Topsent, 1891); may be associated with *Axinella dissimilis*.

Distribution Known recently from Anglesey, Selsey Bill, Roscoff, Channel Isles, Lough Hyne. Apparently restricted to the south west of the British Isles?

Identity The appearance, with conspicuous subsurface channels, is not very distinctive. The spicule complement, however, is fairly distinctive: there are apparently several species of *Phorbas* with similar spiculation, but differing in the size and relative abundance of the isochelae, and the size, shape and spination of the acanthostyles. *Phorbas bihamigera* is very similar to this species, but has abundant chelae of two size classes in a surface layer. The channels are more noticeable in close-up photographs *in situ*.

References Topsent, 1891, p.523; 1934, p.1.

Sources D. Moss (G. Ackers, B.E. Picton).

Editors D. Moss, B.E. Picton.  
 Draft 1 2/90

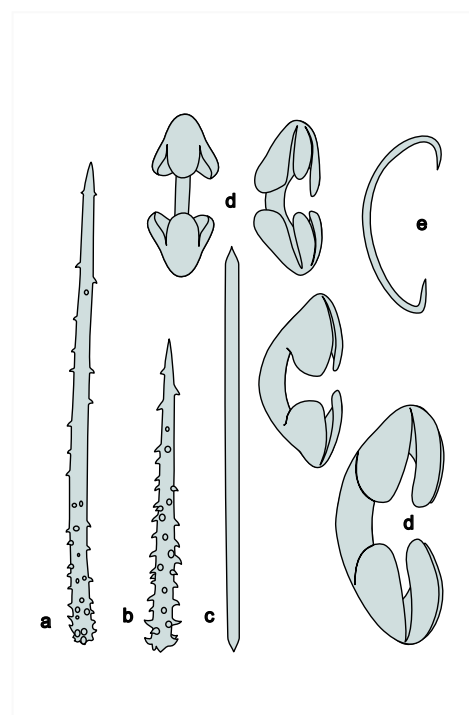

***Plocamionida ambigua* (Bowerbank, 1866: 136)**

Family	HYMEDESMIIDAE
Synonyms	<i>Microciona ambigua</i> Bowerbank, 1866: 136.
Form	Thin sheets, up to ca. 20cms across.
Photographs	BELUM: Mc1780. E. of Mewstone, Skomer, south Wales. (B.E. Picton)
Colour	Pale red (Mediterranean specimens), orange, yellow or ochre. Grey-brown in alcohol, light brown dried.
Smell	None
Slime	None
Consistency	Soft, but difficult to determine as very thin.
Surface	Even, hispid. (?Tuberculate, Mediterranean specimens).
Apertures	Oscules numerous and small.
Contraction	None



**Skeleton** A basal layer of acanthostrongyles lying tangentially to the substratum with short, entirely spined acanthostyles oriented more or less at right angles to the substratum with their heads towards the base. Much larger acanthostyles with spines almost confined to the head regions project from this basal layer. There is a surface layer of tornotes arranged more or less tangentially. Chelae arcuatae are scattered sparsely in a layer near the surface.

**Spicules** The principal spicules of the main skeleton are large acanthostyles, measuring 500-750µm, “to 2000µm”. They are minutely and basally spined. The auxilliary skeletal spicules are smaller, entirely spined, acanthostyles, ca. 155-400µm.

In juvenile specimens these auxilliary acanthostyles echinate the substrate, and they echinate the indistinct plumose columns of large acanthostyles in mature forms. (Note that for Mediterranean specimens, the lengths of these two categories of acanthostyles are given as up to 375µm, and 110-130µm respectively - i.e. **much** shorter than quoted above). Acanthostrongyles form a basal layer on the substratum. They are entirely spined, curved, possess (often unequally) swollen ends, and can be distorted and variable; 70-180µm in length.

The ectosomal spicules are straight, very slender tornotes, ca. 200-420µm in length. They may have short and simple mucrons at their ends. The microscleres are chelae arcuatae with slightly curved shafts, ca. 19-37µm.

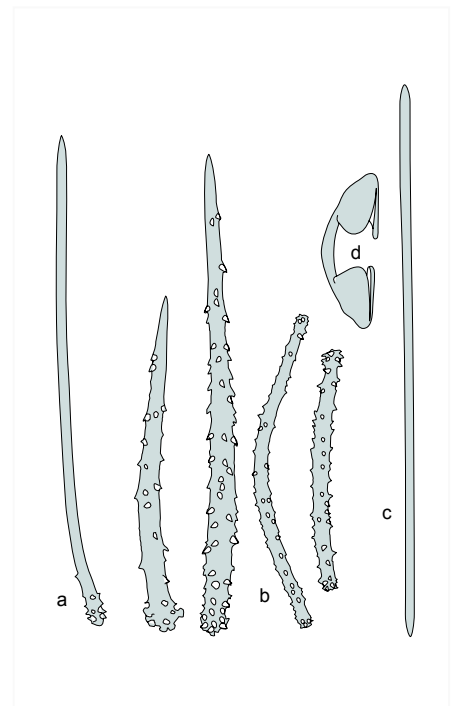

Voucher	BELUM : Mc1528. Ardnoe Point, Sound of Jura, Scotland.
Habitat	On bivalve shells, stones, bedrock and saddle oysters; on <i>Posidonia</i> in the Mediterranean, 45-360m.
Distribution	Channel (Straits of Dover, Roscoff), Shetland, Norway, Sweden, and more generally in the N.E. Atlantic. Mediterranean. Known recently from Firth of Lorne (W. Scotland), N. and S.W. Ireland. Not uncommon.
Identity	The diagnosis for the genus <i>Plocamionida</i> is a <i>Microciona</i> like skeleton, with diactinal ectosomal spicules (tornotes), and chelae with curved shafts. This is based on a misconception as this genus truly belongs in the Hymedesmiidae! A basal layer of fairly distinctive asymmetrical acanthostrongyles immediately suggests this species, but beware <i>Plocamiancora arndti</i> , which is not uncommon in the Sound of Mull and around Rathlin Island. It has anchorate chelae and more robust, symmetrical acanthostrongyles.
References	Arndt, 1935, p.87. Bowerbank, 1866, p.136; 1874, p.65. Topsent, 1936, p.51.

Source G. Ackers (B.E. Picton).

Editors D. Moss, B.E. Picton.

Draft 1 2/90

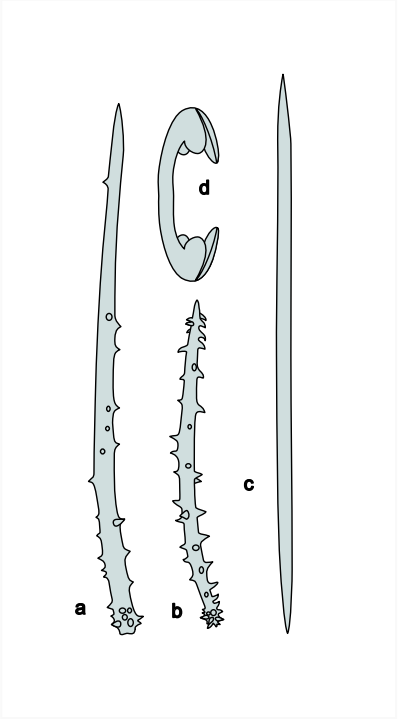

***Crella rosea* (Topsent, 1892:xxiii)**

Family	CRELLIDAE	
Synonyms	<i>Yvesia rosea</i> Topsent, 1892:xxiii, <i>Pytheas rosea</i> (Topsent, 1892:xxiii) Lévi, 1950.	
Form	Massive-lobose. A series of lobes joined into an extensive sheet to 30cm or more across and 3cm thick.	
Photographs	BELUM: Mc1739. Calf of Man. (B.E. Picton)	
Colour	A rather watery orange grading into a purplish tinge, often brownish - orange or reddish-brown; also yellow. "Rose red."	
Smell	None - slight.	
Consistency	Fairly soft but quite tough.	
Surface	More or less transparent with densely packed inhalant pores gathered into groups. These inhalant areas are quite distinctive as the surface between the pore areas is less transparent.	
Apertures	Oscules large, allowing a view of the excurrent channels; terminating lobes of the body. One or two dark exhalant canals run down the sides of the oscular lobes. In contracted preserved specimens this appears as a smooth groove.	
Contraction	Considerable, changing the rounded appearance to a more angular one.	
Skeleton	Plumose. The main skeleton is of thick multispicular ascending fibres of strongyloxea. Large straight (endosomal) acanthostyles echinate the substrate, and smaller curved (ectosomal) ones are present throughout the body. The surface skeleton is a dense tangential layer of acanthostyles. Spongin may be present in large amounts, encasing the spicules in the ascending fibres.	
Spicules	Megascleres include strongyloxea (c), 300-(310)-340µm; ectosomal acanthostyles (b), 88-(110)-130µm long, entirely covered with very strong conical spines; and endosomal acanthostyles (a), entirely spined, typically 125-220µm in length. Microscleres are arcuate isochelae, ca. 18µm, found especially at the surface.	
Voucher	BELUM : Mc48. Portquin. N. Cornwall.	
Habitat	Found on steeply inclined and vertical rock faces in moderately and fully exposed headlands, channels and open coast.	
Distribution	"Norway; Roscoff; Mediterranean etc." Known recently from Kellan Head, near Padstow, N. Cornwall; Scilly Isles, Wolf Rock; S. Devon; Skomer Is, S. Wales; Calf, Isle of Man; Blasket Islands, Co Kerry. Apparently a southern species in the British Isles.	
Identity	Appearance is characteristic, somewhat reminiscent of <i>Myxilla rosacea</i> . Spicules, especially surface acanthostyles, are very distinctive, and are one of the diagnostic features separating the Crellinae from the Phorbasinae. In most <i>Crella</i> species these ectosomal acanthostyles are found only in a dense surface layer, but in this species they are found throughout the body of the sponge.	
References	Arndt, 1935, p.77. Topsent, 1925, p.688.	
Sources	B.E Picton, (G. Ackers). Editors D. Moss, B.E. Picton.	

***Mycale (Aegagropila) contarenii* (Martens, 1824: 455)**

Family	MYCALIDAE
Synonyms	None in common use.
Form	Varies from sheets or cushions of unequal thickness to massive-lobose. The lobes may become elongate and anastomose, leading to a superficially ramose appearance. Specimens can grow to a considerable size - at least 10cm diameter and thickness.
Photographs	Kylesalia Creek, Kilkieran Bay, Galway, Ireland. (B.E. Picton)
Colour	Yellow, yellow green. "A live, ochrous yellow (never red)"; "pinkish grey". "Preserved, white to light brown".
Smell	Quite marked: sweetish-pungent(!)
Slime	None.
Consistency	Firm to soft, even. "Firm, compressible".
Surface	Typically covered by small conules, raised up by the skeletal fibres, giving the surface a somewhat reticulate appearance.
Apertures	"Oscules few, large when open, found at summits of the lobes or scattered and carried on membranous fistules on encrusting forms".
Contraction	Slight in encrusting form.
Skeleton	Plumoreticulate. The main skeleton is an irregular reticulation of multispicular fibres. The ectosomal skeleton is a tangential, comparatively feeble, triangular or polygonal reticulation of multispicular fibres. Spongin reinforces the skeletal fibres to a varying degree.



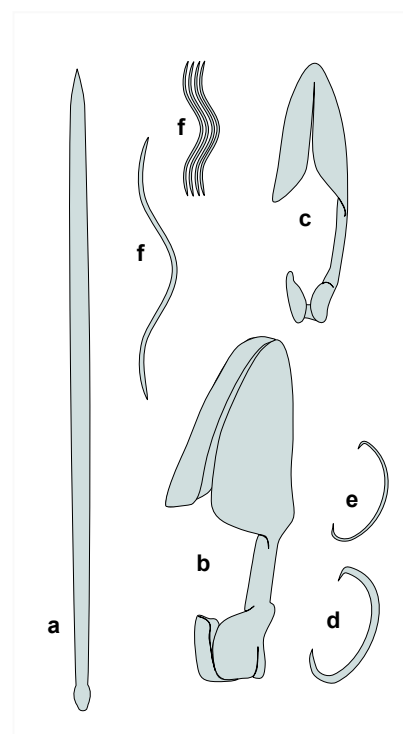

Spicules	The megascleres typically are slightly curved (sub)tylostyles (a), thicker towards the pointed end, with a more or less pronounced head; length 220-(275)-320 $\mu$ m, varying between individuals. The microscleres includes palmate anisochelae in 3 size groups. The largest (b) are ca. 31-47 $\mu$ m and, when present in any numbers, are grouped into rosettes in the surface. The middle size (ca. 12-25 $\mu$ m) are solitary and variable in number (and may even be absent). The smallest isochelae (c) are solitary, often abundant, with one tooth characteristically standing out from the shaft giving the spicule a noticeably angular profile, ca. 13-15 $\mu$ m. Sigmata (d,e) (of two sizes?) are present. The larger are numerous, robust and somewhat twisted, sizes generally in the range 40-65 $\mu$ m. The smaller (if present) are thinly scattered and very slender and consequently sometimes hard to find, ca. 16-22 $\mu$ m. They were not present in the material examined here, though both thick and thin large sigmata were present. Toxa (f) are either single and scattered or, nearly always, in small bundles forming toxodragmata. They are small (ca. 20-70 $\mu$ m) and fine, with a widely extended central flexion. They are always present but sometimes rare and difficult to detect.
----------	--



Voucher	BELUM : Mc1620. Lough Hyne, Cork.
---------	-----------------------------------

Habitat	“Littoral to 37m, growing on stones, shells, algae, sessile coelenterates and <i>Chlamys varia</i> ”. On boulders, cobble, at sheltered sites with moderate tidal streams.	
Breeding	Reproduces in summer by budding, buds located at summits of the conules.	
Distribution	“British Isles. Common along the Atlantic coast of France and Spain; Mediterranean”. Azores.	
Identity	The appearance alive is distinctive but probably not diagnostic. That, combined with a microscopic examination, should provide a ready identification; cf. <i>Mycale macilenta</i> (q.v.).	
References	Arndt, 1935, p.47. Topsent, 1924, p.91.	
Sources	S.M. Stone (D. Moss, B.E. Picton).	Editors D. Moss, B.E. Picton. Draft 1 2/90

### ***Mycale (Mycale) lingua* (Bowerbank, 1866: 187)**

Family	MYCALIDAE	
Synonyms	<i>Esperia placoides</i> Carter, 1876: 316, <i>Esperella murrayi</i> Ridley & Dendy, 1886: 338.	
Form	Encrusting to massive-lobose to massive-fig. Various described as being “roundish”, “resembling the tongue of a sheep”, or “an inverted triangular pyramid”. It is apparent that some specimens tend to grow in an erect, flattened form, with the attached base narrower than the apex. Grows up to 30 cms in height, with variable width and depth.	
Photographs	Loch Seaforth, Harris, Outer Hebrides. (B.E. Picton)	
Colour	Grey, pale buff. (In spirit, “pale yellow”, “whitish yellow or gray”. The specimen in GA’s collection is dull greenish yellow in spirit).	
Smell	None observed.	
Slime	None.	
Consistency	Rather tough, very fibrous, but easily compressed.	
Surface	Sulcate, the furrows forming an irregular reticulation over the surface. Within the furrows, the dermal membrane is smooth, elsewhere it is rather shaggy in appearance (like “sun-cracks upon a cake of mud”).	
Apertures	Oscules are borne on shallow, transparent cones of height 2-3mm, and have a diameter of 4-10mm. The inhalent pores lie along the surface of the furrows, and can only be seen with the aid of a microscope in preserved material but are obvious in living specimens.	
Contraction	The sulcate cracks close on collection.	
Skeleton	Phemoreticulate, of ascending multispicular fibres of styles, with small amounts of spongin binding the fibres. Towards the surface, some fibres run parallel to the surface, and some become splayed like a brush and penetrate the surface.	
Spicules	Megascleres are styles (a), usually straight, occasionally slightly curved, 460-(510)-560 [530-1150] x 13-20µm. Their ends are variable in shape. The head may be that of a typical style, or may tend to that of a subtylostyle, or may be constricted like a handle. The points may be abrupt or long.	

Microscleres are palmate anisochelae (b,c), sigmata (d) and trichodragmata, (e). The anisochelae fall into two distinct size classes, ca. 35 $\mu$ m and 70 $\mu$ m, the larger ones (b) being found in rosettes, mainly near the dermal membrane. Sigmata are ca. 16-32 $\mu$ m in length. Trichodragmata are ca. 42-78 $\mu$ m long and 11-14 $\mu$ m thick.

Voucher	BELUM : Mc1345. Brittany, France.	
Habitat	Found at depths between 30m and 2460m.	
Distribution	Widely distributed over the north Atlantic, from the Azores to Spitzbergen. Also known from the Mediterranean, north west coast of America and Australia. At depths accessible by SCUBA, the distribution of this essentially deep water species is probably localised into discrete areas. Known recently from Ushant, Brittany; Rathlin Is; Loch Sunart, Insh Is. and Bach Is, Firth of Lorne; Faeroes.	
Identity	The furrowed grooves on the surface of the sponge are highly characteristic.	
References	Ridley and Dendy, 1887, p.67. Topsent, 1892, pp.88 and 89. Lundbeck, 1905, pp.24 and 29. Topsent, 1924, p.86	
Source	G. Ackers, B.E. Picton.	Editors D. Moss, B.E. Picton.

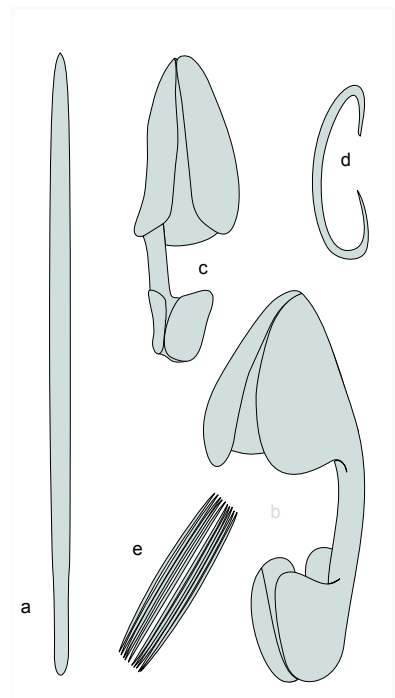

Draft 1 2/90

### *Mycale (Carmia) macilenta* (Bowerbank, 1866:176)

Family	MYCALIDAE
Synonyms	None in common use.
Form	Thinly encrusting with irregular outlines when growing on rock. Can become a thick cushion when growing on living Queen scallops <i>Aequipecten opercularis</i> (though possibly this is a separate species).
Photographs	1. Lee's Wreck. (encrusting form). (B.E. Picton) 2. Caolas Cregan, L. Creran, west Scotland (on <i>Aequipecten opercularis</i> ). (B.E. Picton)
Colour	Alive, the encrusting form is normally pale yellow or green. The form on <i>Aequipecten</i> varies from brown to purple or "vivid red". When preserved it is "yellow or brown".
Smell	None
Slime	None
Consistency	Soft, easily crushed.
Surface	Smooth, velvety.
Apertures	Oscules are clearly visible in living sponges, slightly raised above the general level of body, with transparent rims which collapse on collection. In thinly encrusting specimens transparent excurrent channels can be seen converging on oscules. Cushions on <i>Aequipecten</i> may only have a single oscule.
Contraction	Slight contraction occurs and osculae close.



Skeleton	Plumoreticulate, of ascending multi-spicular fibres of subtylostyles (“which do not divide or anastomose”), ending in loose brushes at the surface, with scattered megascleres lying in between. Rosettes of larger anisochelae frequent near the surface, with smaller anisochelae scattered throughout tissue. There is no specialised ectosomal skeleton. The surface is supported by the widely spaced, terminal brushes of the main skeleton, with a few single megascleres (sometimes these are absent altogether) scattered in the large interstices. Spongins is minimal.	
Spicules	The megascleres are generally straight-shafted, slightly fusiform, subtylostyles (a), with barely formed elliptical heads, between 200-(270)-300µm long. The microscleres include palmate anisochelae of three sizes. The largest (b) are grouped into rosettes in the ectosome (ca. 33-59µm). The middle size are solitary and scarce (ca. 17-24µm). Those of the smallest size (c) (11-15µm) are very abundant and widely dispersed throughout the body. They have a distinctive lower tooth which is very short and curved in towards the shaft. The sigmata (d) group into two size categories (65-115µm and 21-28µm); the larger ones are always less frequent and both sizes may be scarce. Toxa (e) are variable in length (60-250µm) and width, but usually frequent.	
Voucher	BELUM : Mc1536. Lough Hyne, Cork.	
Habitat	Littoral to at least 40m, encrusting mainly on <i>Pecten</i> and <i>Aequipecten</i> . On rock faces and wrecks in both sheltered and exposed conditions. Apparently fast growing. “Also on <i>Laminaria</i> and hydroids.”	
Distribution	Common along the Channel coasts of “British Isles; France”. Also “Belgium”; Atlantic coasts of “France; Spain”; and “Mediterranean”. Common on <i>Aequipecten</i> in Strangford Lough and Scottish sea lochs. The encrusting form has been found in Strangford Lough entrance, in Lough Hyne and at St Kilda.	
Breeding	“Breeds with abandonment between August and mid-October. Larvae are found at the base of the sponge.”	
Identity	The most difficult of all the <i>Mycale</i> spp. to recognise, as its appearance and spiculation can be so variable. (This may indicate a complex of closely related species!) It most closely resembles <i>Mycale contarenii</i> (q.v.) but can be distinguished by the relative rarity of large sigmata, presence of small sigmata, and large and small toxa, the toxa not being grouped in bundles. <i>Mycale similaris</i> (q.v.), is also similar but the presence of trichodragmata in the latter helps to distinguish the two species, although these spicules are so small that they can easily be overlooked.	
References	Arndt, 1935, p.48. Topsent, 1924, p.105.	
Source	S.M. Stone, B.E. Picton.	Editors D. Moss, B.E. Picton.

### ***Mycale (Aegagropila) rotalis* (Bowerbank, 1874:327)**

Family	MYCALIDAE
Synonyms	None in common use.
Form	Thin sheet to thick cushion to massive-lobose (?), with smooth, irregular lobes.
Photographs	Rutland Harbour, Donegal. (B.E. Picton)
Colour	A more or less bright carmine-red,” rarely rose-red”, very conspicuous.
Smell	None.
Consistency	Fairly soft but quite tough. “Resilient.”



Surface	Distinctive - a closely packed series of dots can be seen under close examination or slight magnification. Porous, with dark spaces under the surface membrane. "Smooth, uneven."	
Apertures	Oscules are few, large, conspicuous, "scattered and varying in size". They are slightly raised above the surface, and the ends of the excurrent channels can be seen as membranes inside each oscule.	
Contraction	Slight - oscules close.	
Skeleton	Plumoreticulate. The main skeleton consists of an irregular reticulation of multispicular fibres (of subtylostyles). The ectosomal skeleton is a tangential, triangularly meshed reticulation of multispicular fibres. Spongin reinforces the skeleton fibres to a varying degree. The ectosomal membrane is easily detached.	
Spicules	Megascleres are stout, straight-shafted subtylostyles (a), 240-(280)-300µm long. Loose interstitial subtylostyles lying between the fibres are often flexuous. The microscleres are palmate anisochelae of 3 sizes (b) (ca. 30µm, 25µm and 15µm). None of these form rosettes. In other <i>Mycale</i> spp. the largest anisochelae usually do form rosettes. Also present are sigmata (c) of two sizes, ca. 65-70µm and 20-25µm.	
Voucher	BELUM : Mc475. Tiree, Hebrides.	
Habitat	On vertical rock faces in sheltered, and also very exposed, sites. On boulders and rocks in sheltered areas with moderate to strong tidal streams. "Also on shells (e.g. <i>Chlamys</i> ), stones, seaweed, hydroids, and in rock crevices."	
Distribution	Widely distributed and common; "British Isles; France and Mediterranean". Known recently from Co. Wexford; Lough Hyne, Co. Cork; Co. Galway; N. coast of Co. Donegal; Strangford Lough, Co. Down; Tiree, W. Scotland.	
Identity	The characteristic surface, once seen, is very distinctive. There is potential confusion with many other red encrusting species, but most are much thinner crusts. The spicule complement will immediately confirm <i>Mycale</i> spp. and the particular microsclere combination present confirms <i>Mycale rotalis</i> . Note the lack of rosettes of anisochelae in this species.	
References	Arndt, 1935, p.50. Topsent, 1924, pp.100-105.	
Sources	B.E. Picton, S.M. Stone. Editors D. Moss, B.E. Picton. Photograph 79.	

### ***Mycale (Carmia) similaris* (Bowerbank, 1874:319)**

Family	MYCALIDAE
Synonyms	<i>Rhaphiodesma sordida</i> Bowerbank, 1874:230,354, <i>Esperella sordida</i> (Bwk., 1874) Topsent, 1890:201, <i>Hymeniacidon subclavata</i> Bowerbank, 1866:209.
Form	Thin sheet, cushion or massive-lobose, very irregular in shape.
Photographs	Mc335 Horse mussel beds, Strangford Lough, Down. (B.E. Picton)
Colour	Typically orange-red, also "brown, yellow, white (the latter as small patches underneath <i>Lithothamnium</i> )". Colour is due to certain substances found in the spherule cells, seen in the matrix in a transverse section.
Smell	None.



Consistency	Fairly soft but tough.	
Surface	Transparent with darker pore areas. “Even, conulose.” The ectosomal membrane is without spicules and supported, but rarely pierced, by ascending spicular brushes, causing the conulate appearance.	
Apertures	A few large oscules at the tops of the lobes. These are “scattered and fistular” in cushion forms. Converging excurrent channels are visible as darker streaks. Pores ‘sprinkled’ across the surface give it a punctate appearance.	
Contraction	Slight.	
Skeleton	Plumoreticulate, of ascending multispicular fibres of subtylostyles, reinforced with variable amounts of spongin. There is no specialized ectosomal skeleton. In juvenile specimens the fibres are well spaced and independent but, as the sponge matures, the fibres branch and anastomose, and the plumosely arranged network becomes apparent.	
Spicules	The megascleres are long, straight-shafted subtylostyles (a) with barely formed elliptical heads, mostly 255-(275)-290µm. Microscleres include palmate anisochelae (b) of 3 sizes (ca. 40µm, 20µm and 12µm), the largest grouped into rosettes of 12-20 spicules in the ectosome. Sigmata (c) of two sizes, the largest (ca. 65µm) are always present and numerous, whereas the smaller (ca. 37µm, of variable thickness) can be rare. Toxa (d) (ca.200µm) are very long and fine with a very abbreviated central flexion in proportion to the overall length, and with the ends gently recurved; these may be very rare. Trichodragmata (e) (ca. 27-32µm), of characteristic ‘spindle-shape’, are very small and can be overlooked.	
Voucher	BELUM : Mc437. Strangford Lough, Down.	
Habitat	“ELWS to 30m, growing on a wide variety of Mollusca, including <i>Ostrea</i> , <i>Pecten</i> and <i>Chlamys</i> ; on <i>Lithophyllum</i> , <i>Fucus</i> , <i>Sertularia</i> , stones and rocks.” In Strangford Lough this species occurs on clumps of <i>Modiolus modiolus</i> (horse mussels) and <i>Chlamys varia</i> in an area of moderate current (max. 1 knot).	
Distribution	“British Isles; France; Mediterranean.” Known recently from Strangford Lough and the Sound of Jura.	
Identity	The spicule complement, especially the large toxa and characteristic trichodragmata, is quite distinctive. Until more is known about the live appearance of other Poecilosclerida it is difficult to say how characteristic the external appearance is. Mycalid species most readily confused with this species are <i>Mycale contarenii</i> and <i>Mycale macilenta</i> (q.v.), but colour, shape and size of toxa and presence or absence of trichodragmata can help in distinguishing them. In life confusion with <i>Mycale rotalis</i> is more likely.	
Reference	Topsent, 1924, pp.109-113.	
Sources	B.E. Picton, S.M. Stone. Editors D. Moss, B.E. Picton.	

### ***Biemna variantia* (Bowerbank, 1858:327)**

Family	DESMACELLIDAE
Synonyms	<i>Desmacella variantia</i> (Bwk, 1858:327) Lundbeck 1902:98, <i>Biemna peachii</i> (Bwk, 1866:276).
Form	Encrusting, becoming a thick cushion (e.g. 1-1.5cm thick by 7cm diameter; thickest at the centre and tapering to the edge). “It can grow into cuplike or lamellate forms when mature” (?).
Photographs	Lee’s Wreck, Strangford Lough, Down. (B.E. Picton)
Colour	Beige, occasionally yellow.



Smell	None.
Consistency	Very soft and friable.
Surface	Uneven with conulose projections, due to the ends of spicule fibres supporting the surface, rather like <i>Dysidea</i> . Larger specimens may have a distinctly 'lumpy' or shaggy appearance due to development of surface projections.
Apertures	Several oscules, scattered across the upper surface of the sponge, seen as dark holes in surface. Inhalent pore areas are obvious between conulose projections when seen alive.
Contraction	Slight.
Skeleton	Plumose. Stout multispicular fibres (of styles), branching and anastomosing, ascend through the sponge and support the surface. Tissue is packed with abundant microscleres. Minimal amounts of spongin are present.
Spicules	Megascleres are styles (a) 360-(580)-700µm abruptly bent near the rounded end. Microscleres are sigmata (b) of two size categories, ca. 50-70µm and ca. 10-20µm; raphides (c), ca. 165µm, gathered loosely into trichodragmata, and commata, 63µm, which are like small, straight, fusiform oxea. These microscleres are very numerous and are easily lost from the sponge and so may contaminate samples of other species if put together into the same container.
Voucher	BELUM : Mc319. Strangford Lough, Down.
Habitat	On vertical surfaces with moderately strong water movement. At Hake Island, Sherkin Island, on underside of boulders; "on mud, gravel, stones". Tolerant of brackish conditions in Daucleddau estuary, Milford Haven.
Distribution	"Arctic-boreal south to ca. 40°N. Mostly recorded from deep water, although type locality (Tenby) was intertidal." Known recently from Strangford Lough; Lough Hyne; Sherkin Island; Blaskets; Skomer; Milford Haven; Guernsey.
Identity	The appearance is quite characteristic but a check of the spicules is necessary for confirmation.
References	This species has had a chequered taxonomic history and a revision may decide that its name has been too severely compromised and has to be changed. See: Arndt, 1935, p.54. Bowerbank, 1866, p.171; 1874, p.84. Wiedenmayer, 1977, p.161. Wilson, 1925, pp.422-424.
Sources	B.E. Picton, S.M. Stone. Editors D. Moss, B.E. Picton.

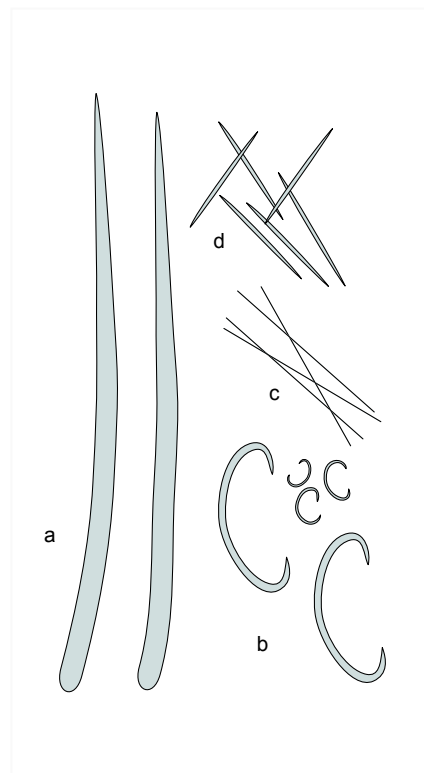

### ***Amphilectus fucorum* (Esper, 1794:278)**

Family	ESPERIOPSIDAE.
Synonyms	<i>Isodictya fucorum</i> , <i>Isodictya edwardii</i> , <i>Isodictya normani</i> , <i>Isodictya gracilis</i> , <i>Isodictya uniformis</i> , (all Bwk., 1866), <i>Esperiopsis fucorum</i> (Esper, 1794) Topsent, 1890:201.
Form	Extremely polymorphic and fast-growing, changing shape in a few weeks. Encrusting as thin sheets or cushions, Massive lobose; with or without 'tassels', or branched. It can also occur in hollow 'amphora' shaped forms in sheltered conditions.
Photographs	Whirlpool Cliff, L. Hyne, Cork. (B.E. Picton)
Colour	An intense reddish orange. The pigment squeezes out easily between thumb and forefinger. It goes colourless in alcohol. The sponge may be colourless in deeper water.



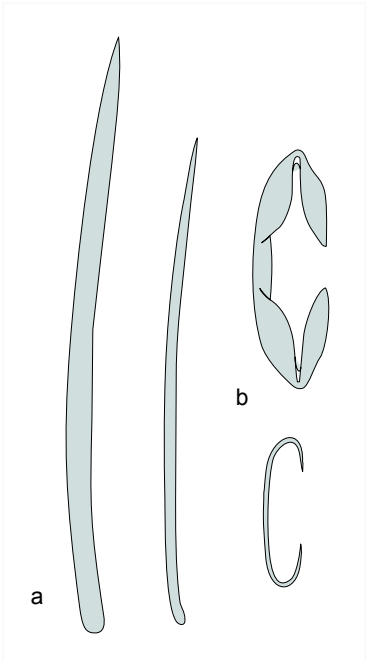

Smell	A characteristic and unpleasant strong smell - not dissimilar to that of <i>Halichondria panicea</i> . Not present in 'amphora' form?	
Slime	None produced.	
Consistency	Soft and easily torn, very compressible.	
Surface	Even. Minutely hispid. Moderate friction. Fairly open in appearance. The sub-ectosomal tissue is peppered with inhalent pore channels which are covered with a thin, transparent layer. This is apparent in the field.	
Apertures	The oscules may be only slightly raised from the surface or be characteristically at the top of volcano-like growths and may have 'tassel' growths originating near the margin of the oscules. The oscules do not contract. They are inconspicuous in encrusting forms, and large or crateriform in massive forms; they are often arranged in linear series in the branching forms.	
Contraction	Slight.	
Skeleton	Plumoreticulate. The main skeleton is an isodictyal to sub-isodictyal reticulation of multispicular fibres, reinforced with variable amounts of spongin (depending on the age of the sponge). There are no echinating spicules, nor any special ectosomal skeleton.	
Spicules	The megascleres are smooth, usually curved, styles (a) 170-(225)-500µm and 150-(170)-200µm. The micro-scleres are small palmate isochelae (b) (20µm), which may be rare in some specimens. These chelae are typical of the Microcionidae (Clathriidae) and may indicate that this species should be placed in that family (BEP).	
Associations	Amphipods and nematodes. The aberrant polychaete worm <i>Spinther oniscoides</i> is often found associated with this sponge.	
Voucher	BELUM : Mc175. Strangford Lough, Down.	
Habitat	A wide range, from sheltered sites to extremely exposed ones. It may be found in strong tidal rapids, e.g. Menai Straits and Strangford narrows; on rock and under stones; amongst hydroids (it will grow up <i>Tubularia</i> stems); and has even been found on ascidian tests. It is often found growing on/in <i>Laminaria</i> holdfasts on the lower shore and shallow sublittoral. The 'amphora' form grows on shells in sheltered places. An infralittoral species, seldom found in the circalittoral zone.	
Distribution	A common and widespread species in the British Isles. Voucher specimens from: Faeroe, Strangford Lough; Menai Straits; W. Anglesey; Skomer; Lundy; Cornwall; W. Sussex; Tiree. "Atlantic coasts of Europe, from Norway to France."	
Identity	The shape of this sponge is very variable and is in many ways almost as polymorphic as <i>Halichondria panicea</i> ; like <i>Halichondria panicea</i> it also occurs in a wide variety of situations. It is a very common species in the shallow sublittoral, especially in areas of increased water movement, e.g. tidal narrows. The smell, nature of the tassel form, the oscules, colour and surface texture in combination are useful in helping recognition of this sponge, whilst alive or freshly collected.	
	S.M.S.: 'A problematic species undergoing taxonomic review. Treat all identifications as provisional at present. There are a large number of Bowerbank synonyms to be checked which may result in a 'splitting' of the entity <i>A. fucorum</i> as now understood. <i>Corybas lobata</i> (q.v), is probably closely related to <i>A. fucorum</i> ; the spiculation of the two species is almost identical.' However, <i>Corybas</i> has a more regular skeleton of ascending bundles of styles with single connecting styles. The chelae of <i>Corybas</i> are anisochelae (but with only slightly disparate ends). <i>Corybas</i> is cream coloured when alive. <i>In situ</i> , <i>Amphilectus</i> is one of at least 5 species of common red or reddish-brown encrusting sponges, but the soft texture and open surface of <i>Amphilectus</i> are quite distinctive.	

References Arndt, 1935, p.53.  
Hiscock, Stone and George, 1983[1984], p.26.  
Uriz, 1983, pp.237-240.

Sources B.E. Picton, S.M. Stone, G. Ackers, D. Moss.

Editors R.Earl, D. Moss, B.E. Picton.

## *Amphilectus lobata* (Montagu, 1818: 85)

Family ESPERIOPSIDAE

Synonyms *Isodictya lobata* Bowerbank, 1864: 139,  
*Isodictya (Halichondria) clarkei* Bowerbank,  
1864: 330, *Corybas lobata* Gray, 1867: 537,  
*Chalinula ovulum* G. Schmidt, 1870: 38,  
*Mycale ovulum* Lundbeck, 1905: 34, *Corybas*  
*ovulum* Arndt, 1935: 50.

Form 4-15mm round, egg-shaped, or flattened cushions growing on brown algae, hydroids or erect bryozoans. Larger specimens are cylindrical or rather irregular in shape as a result of growth along the branches of the substrate organism and coalescence of originally separate individuals.

Photographs Zara Shoal, Strangford Lough, Down. (B.E. Picton)



Colour Pale yellow, beige.

Smell Strong, pungent: "Garlic", "*Halichondria panicea*".

Slime None.

Consistency Slightly elastic, very soft.

Surface Very finely hispid.

Apertures On small cushions there is a single oscule, flush with the surface; larger specimens may have oscules in rows along a ridge, or somewhat scattered; Ostia in the dermal membrane.

Contraction None noticeable.

Skeleton Primary polyspicular bundles, cross-linked here and there by single spicules, run from the substratum to the surface. The arrangement may be somewhat confused basally, but becomes more uniform near the surface. In the primary bundles (in which 6-8 spicules may be closely set side by side) the spicules (curved styles) all have their pointed ends in the direction of the surface. The primary bundles may curve along their lengths. The transverse interlinking spicules are also styles. The dermal membrane is largely clear of styles, but contains scattered anisochelae. Spongin is not obviously abundant, and is colourless.

Spicules Megascleres are more or less curved styles (a), the curvature occurring nearer to the rounded end of the spicule. They are slightly thicker in the middle region (fusiform) and slightly constricted just above the head. Lengths are 145-(190)-230 $\mu$ m (up to 310 $\mu$ m in some specimens), with widths of 2-4 and 7-10 $\mu$ m (even 11 $\mu$ m sometimes). Anisochelae (b) are variable in size, from 15-23 $\mu$ m in length. They also vary greatly in the relative sizes of the chelate ends. "In some specimens the difference between the ends is so slight as to suggest isochelae", but usually the size difference is considerable. In some specimens considered to be the same species the anisochelae can be up to 45 $\mu$ m in length.

Voucher BELUM : Mc1838. Milford Haven, Pembroke, Wales.

Habitat Almost always found on weed, hydroids, erect bryozoans, in low-lying littoral rock pools and in the infralittoral zone to 200m depth; usually in strong water movement. May be common coating the basal portion of the hydroids *Hydrallmania falcata* and *Sertularia argentea* in tidal streams of 3-7 knots. Often found in rias and sea loch entrances.

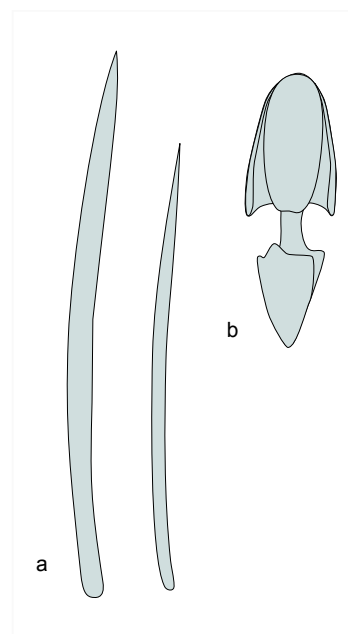

Distribution	North Atlantic: Devon, North Wales, Faroe Isles, Kattegat, Norway, Iceland, Greenland, Baltic Sea, White Sea. Common in the entrance to Carlingford Lough and the narrows of Strangford Lough, Co. Down, N. Ireland; and in Milford Haven and Daucledau River, Pembrokeshire.	
Identity	A spicule preparation or thin, cleared section of the sponge is required. The variable anisochelae and the smooth styles are diagnostic. There might be confusion with <i>Amphilectus fucorum</i> (q.v.), but in this species the microscleres are isochelae, the skeletal arrangement is more regular and usually the colour of the sponge is reddish-orange.	
Reference	Lundbeck, 1905: 34 ( <i>Mycale ovulum</i> ).	
Sources	W.C. Jones (G. Ackers, B.E. Picton).	Editors D. Moss, B.E. Picton.

---

### ***Axinella damicornis* (Esper, 1794:249, pl.xxix)**

Family	AXINELLIDAE	
Synonyms	None in common use.	
Form	Branching-erect with branches compressed and 'webbed' together. Variable in appearance. Up to 10 cm in height, with short stalk. The fusion of the branches tends to result in irregular growth forms in taller specimens. In lower growing, squatter specimens the lamellae become fused and convoluted, producing growth forms that are not unlike miniature 'ross coral' ( <i>Pentapora foliacea</i> ). The terminal branches are about 3mm in diameter.	
Photographs	The positions of the oscules are revealed by the small flaps of tissue, the one to the bottom right hand side of the specimen being particularly obvious. Lough Hyne, Cork. (B.E. Picton)	
Colour	Bright to deep yellow, verging sometimes towards deep orange at the margins. Distinctively 'bright'.	
Consistency	Firm with strong axial skeleton. Lamellae are flexible.	
Surface	Characteristic 'mealy' appearance to the surface, as though dusted with small yellow particles. Surface velvety, with projecting spicules of uneven length, approximately twice that of <i>Axinella dissimilis</i> . Wide canals run up the sponge to arrive radially at 'vents' on the distal edges of the lamellae.	
Apertures	Small oscules are borne on the apices of the lamellate branches. When alive, the open oscules are partially surrounded by a small triangular 'flap' of tissue, arising from the oscular rim. On collection this flap cannot be differentiated and the oscules themselves become inconspicuous.	
Skeleton	Plumose. A dense central core composed mostly of bundles of (3 or 4) oxea, forming a plumose reticulation, which terminates in brushes of styles which penetrate the surface.	
Spicules	Strong oxea (a), bent to a greater or lesser degree in the middle, occasionally with tylote swelling(s), typically ca. 400-(450)-520µm. Strong styles to subtylostyles (b), occasionally tylostyles, 420-(630)-1030µm long, slightly bent.	
Voucher	BELUM : Mc1306. Brittany, France.	
Habitat	In Lough Hyne - on vertical cliff face at 15m in sheltered location. In Donegal - on rock reefs at 30m. In both localities <i>Axinella dissimilis</i> is also present. Donegal locations are moderately exposed to wave action. <i>Eunicella verrucosa</i> and <i>Alcyonium glomeratum</i> are also characteristic of the habitat. It occurs in similar habitats in SW Britain, sometimes in silty locations, always (?) on sloping rock surfaces (G.A.). Often found partly hidden in hydroid/bryozoan undergrowth on Lundy. In the Mediterranean this is a common species, often covered with the zoanthid anemone <i>Parazoanthus axinellae</i> .	
Distribution	Scarce in the British Isles. Known recently from Ireland: Lough Hyne, Co. Cork; Skird Rocks, Galway Bay; St. John's Pt., Co. Donegal; Rathlin O'Birne Is., Co. Donegal; Rathlin Is. and Portrush, Co. Antrim; Ardnoc	

point, Sound of Jura, W. Scotland; Scilly Isles; Channel Isles; Devon; Lundy; Roscoff; a common Mediterranean species.

**Breeding** Buds (between May and September in Mediterranean at Banyuls).

**Identity** The overall form is similar to *Stelligera rigida* but the mealy appearance of surface and bright yellow colour are characteristic. Most readily confused with *Axinella verrucosa* (Esper, 1794:275), so far recorded from Roscoff and the Channel Isles (see Table below). It may be synonymous with *Axinella pyramidata* Stephens 1921:63, but this species has only been recorded from Roscoff since it was first described from off Co. Kerry at 68m. Spicule complement confirms *Axinella* sp. but all *Axinella* species have similar spicules with only size and subtle shape differences between species.

The following Table provides a list of visual characters for distinguishing between *Axinella damicornis* and *Axinella verrucosa*. This is a preliminary version and needs field testing.

**Feedback is welcome.**

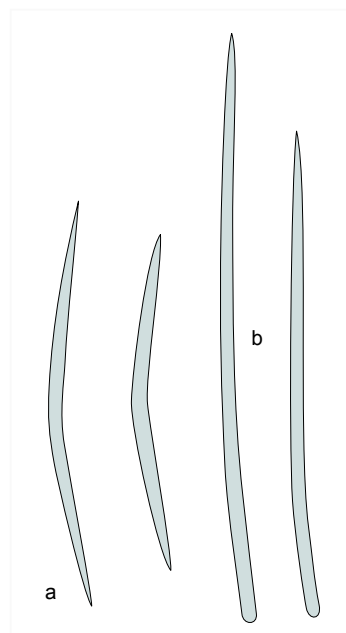

<i>Axinella damicornis</i>	<i>Axinella verrucosa</i>
Strong tendency for branches to fuse.	Branches tend to remain free.
Branches often compressed, never cylindrical.	Branches tend to be cylindrical.
Colour when alive: bright-yellow with 'mealy' surface.	Colour when alive: ochre-yellow to ' <i>Axinella dissimilis</i> yellow'.
'Shaggy', hispidation obvious.	Hispidation not obvious.

**References** Boury-Esnault, 1970, pp.491-496.  
 Hiscock, Stone and George, 1983[1984], p.22.  
 Pansini, 1982 [1983], p.87.  
 Siribelli, 1961, pp.1-24.  
 Topsent, 1934, p.33.

**Sources** B.E. Picton, S.M. Stone, (G. Ackers). Editors D. Moss, B.E. Picton.

***Axinella dissimilis* (Bowerbank, 1866:318.)**

**Family** AXINELLIDAE



**Synonyms** *Isodictya dissimilis* Bowerbank, 1866:318, *Halichondria distorta* Bowerbank, 1866:240, *Tragosia polypoides* (Schmidt, 1862:62) Stephens, 1917:14. This species was known as *Axinella polypoides* in previous editions of this guide, but *Axinella polypoides* is now considered to be a distinct species, probably confined to the Mediterranean Sea.

**Form** Branching-erect, the diameter of the branches varying evenly or unevenly along their length (resembling annulations). The branches are usually oval in cross-section, and may coalesce (see photo. no. 35). In stunted specimens, coalescence may be so pronounced that it results in lamellate forms. Thick stalk.

**Photographs** 1. Banquette Bay, Sark, Channel Isles.  
 2. SW of Rathlin O’Birne, Donegal.  
 3. L. Hyne, Cork. (c/up)

**Colour** Yellow, pale orange, or buff. Turns brown in alcohol.



Consistency	Moderately firm, moderately elastic; surface (but not central core) cracks when axis is bent through 90 deg. (cf. <i>Raspailia</i> , <i>Stelligera</i> and <i>Haliclona oculata</i> in which the surface does not crack with this degree of bending.)	
Surface	Even. Velvety because of the quantity of projecting spicules which are of uniform length.	
Apertures	The oscules are small and regularly spaced along the sides of the branches in flat fan-like specimens or at the edges of lamellate forms. They are placed in depressions and are often opposite, producing the annulate appearance described above. They have a number of short, shallow, surface grooves converging on them. These stellate grooves can be seen readily in preserved material but not underwater. (The grooves are covered with a thin membrane which collapses when the specimen is removed from the water). See photograph. A major distinction in <i>Axinella polypoides</i> is the fact that the osculae are arranged all round the branches.	
Skeleton	Plumose. An axial skeleton of longitudinally orientated megascleres forms a stiff core along the centre of each branch. There is a softer, extra-axial, skeleton of thin fibres, which radiate at right angles from the core towards the surface. These fibres sometimes splay out in plumose fashion to end as brushes at the surface (the majority piercing the surface). The amount of spongin encasing the spicules is variable.	
Spicules	The megascleres are styles (a) 220-(305)-360µm and oxea (b) 180-(200)-210µm - usually both are present. Variations in size between styles and oxea can occur - both can be the same length, or the styles can be longer than the oxea, but the reverse is rarely the case - see note on the variability of the spicule complement under <i>Axinella infundibuliformis</i> . The ectosomal brushes may consist of styles only, and these are often longer than the styles of the main skeleton. Microscleres are trichodragmata (c) scattered throughout the skeleton. These are difficult to see for the first time and need a microscope of good resolution. They look like small ill-defined smudges.	
Associates	Other sponges, commonly <i>Scypha spp.</i> , can be found growing on the branches.	
Voucher	BELUM : Mc1377. Guernsey, Channel Is.	
Habitat	Mainly on upward facing clean or silty rock, usually in deep (30m) water but also shallower - typically found in the circalittoral in SW Britain, but in Jersey and Brittany also occurs in the lower infralittoral, competing directly with foliaceous algae. Prefers clean oceanic water, but tolerates silt. Also reported "on shingle and muddy sand" (??) - confirmation would be valuable.	
Distribution	Typically a southern species, "Madeira, Spain, France, British Isles, (Mediterranean - probably only <i>Axinella polypoides</i> present)". Recently known from SW. Britain, as far north	

as Anglesey, and the Atlantic coast of Ireland as far north as Rathlin Is., Co. Antrim; and with one recent confirmed Scottish record from Loch Scridain, Mull. Not known from North Sea coasts of U.K.

**Identity** The presence of stellate oscular grooves is diagnostic of a closely related group of branched Axinellid species including *Axinella dissimilis*. A number of other branched axinellids have been reported from the continental channel coast but not yet from Britain. See also *Axinella damicornis* and *Axinella flustra*. Specimens on the south side of Skokholm Is, Dyfed, were recently observed to fall into two morphotypes, with smaller, hand-shaped specimens and larger irregular and sparsely branched specimens growing alongside each other. Critical observations and photographs of this phenomenon from other sites would be interesting.

**References** Arndt, 1935, p. 88.  
Bowerbank 1866, pp. 240, 318; 1874, pp. 103, 139.  
Cabiocch, 1968, pp. 221-222(key).  
Hiscock, Stone and George, 1983[1984], p.22.  
Topsent, 1934, p.34.

**Sources** S.M. Stone, B.E. Picton, (D. Moss). Editors J.D. Guiterman, D. Moss, B.E. Picton.

### *Axinella flustra* Topsent, 1892: 122.

**Family** AXINELLIDAE

**Synonyms** *Tragosia flustra* (Topsent, 1892)

**Form** Branching-erect, the branches being very flattened (about 2-4mm thick) and lamellate, all in the same plane, with well rounded ends. There is usually a pronounced basal stalk ca. 1cm long; to about 7cms in height.

**Photographs** Aran Is, Galway. (D.W. Connor)

**Colour** Beige, greyish yellow.

**Smell,Slime** None.

**Consistency** Compact, with flexible branches.

**Surface** Even, slightly tuberculate, and slightly hispid, with moderate friction. Faint star shaped canal patterns are visible in situ.



**Apertures** Oscules inconspicuous, regularly distributed over one surface of lamella.

**Contraction** None.

**Skeleton** The axial skeleton is compressed, conforming to the outline of the branches. The core consists of numerous, irregularly disposed, slender oxea, cemented by variable quantities of spongin. At the periphery of the axial skeleton numerous stouter oxea, orientated parallel to the surface of the axis, are found. Variations on the structure of the axial skeleton occur with styles sometimes present, and the peripheral oxea are not always clearly differentiated.

Large styles echinate the axial skeleton, their heads in the axis, with their points piercing the sponge surface to give the hispid appearance.

**Spicules** Megascleres are styles and oxea. The styles (a) are very variable in size, 300-(685)-900 x 7-20µm, and are usually bent abruptly in the lower one third to one quarter of their length. The oxea (b) are stout, and often strongly curved by an abrupt bend in their centres. They measure ca. 150-(180)-220 x 4-15µm.

Microscleres are trichodragmata, up to 40µm long by 8µm wide. They can be difficult to see.

**Voucher** BELUM : Mc1315. Aran Islands, Galway.

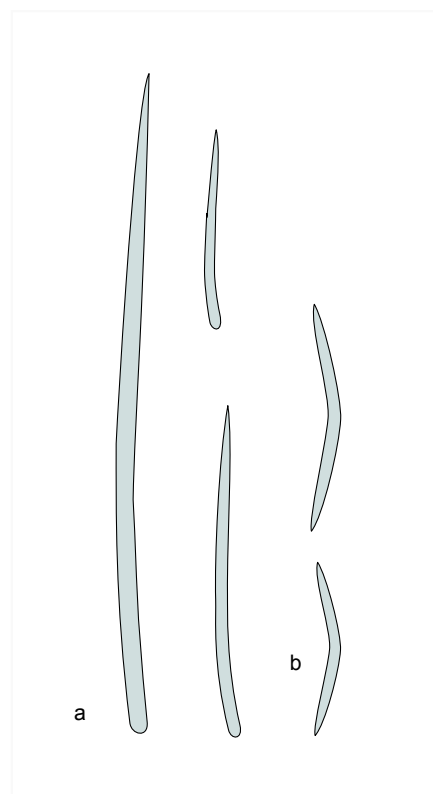

Habitat	Found in rocky areas, often together with <i>Axinella dissimilis</i> (q.v.), from ca. 25-320m. More habitat information is required.	
Distribution	Rare in the British Isles, only having been recorded from Ireland (at ca. 40m on the west side of the Aran Islands). Otherwise known from Brittany, northern Spain, the Azores, and Cape Verde islands.	
Identity	The flattened branches with their even contours give the sponge a resemblance to the bryozoan <i>Flustra foliacea</i> , hence its specific name. Flabellate forms of <i>Axinella dissimilis</i> , <i>Axinella infundibuliformis</i> and <i>Phakellia ventilabrum</i> (q.v.) have thicker branches. <i>Endectyon delaubenfelsi</i> (q.v.) has a similar low growing, erect habit, but with a more complicated branching arrangement. <i>Endectyon teissieri</i> Cabioch 1968 (see under <i>Endectyon delaubenfelsi</i> , this guide) has a very similar growth form to <i>Axinella flustra</i> , but is thinner and more extensively branched.	
References	Topsent, 1892, p.122; 1904, p.139; 1928, p.177.	
Source	G. Ackers, B. Picton.	Editors D. Moss, B.E. Picton. Draft 1 3/90

### *Axinella infundibuliformis* (Linnaeus, 1759:1348)

Family	AXINELLIDAE
Synonyms	<i>Tragosia infundibuliformis</i> (Linnaeus, 1759) Gray, 1867:513.
Form	Variable in shape but usually cup-like or lamellate. The walls are of regular thickness with the margins of the cup/fan rounded and firm. Stalked or substipitate.
Photographs	Insh Is, Firth of Lorne, west Scotland. (B.E. Picton)
Colour	Buff, pale creamy-yellow.
Smell	None.
Consistency	Moderately firm and resilient. Pieces break off if bent through 90 degrees. "Compact."
Surface	The outer surface presents moderate friction when rubbed. The inner surface has many pin hole sized exhalant openings. These are larger than the inhalant pores on the outer surface. Neither surface is bristly.
Apertures	Oscules are "small, scattered evenly" over one surface; in cup-like specimens, all the exhalant openings are found on the inner surface.
Contraction	Not noticeable.
Skeleton	Plumoreticulate. The contrast between a stiffer axial skeleton and a softer extra-axial skeleton, which is characteristic of branched Axinellids, is scarcely noticeable in this species. The megascleres tend to show an axial condensation towards the centre of the choanosome, and a sub-anisotropic reticulation in the extra-axial regions with sub-plumose primary fibres (the amounts of spongin encasing spicules is variable), ending as brushes at the surface. (NOTE: the variability of the spicule complement and architectural structure is a well-known feature of Axinellids. All kinds of combination can be found e.g. megascleres can be all oxea (making confusion with Halichondrida possible), or all styles. If both types are present together, a zonation can often be detected i.e. in a reticulation, the multispicular primary fibres are usually formed by styles and the connective secondary fibres formed of oxea (often unispicular or up to 3 spicules thick). Surface brushes may consist of long or short spicules which pierce the surface (resulting in a rough surface, smooth surfaces

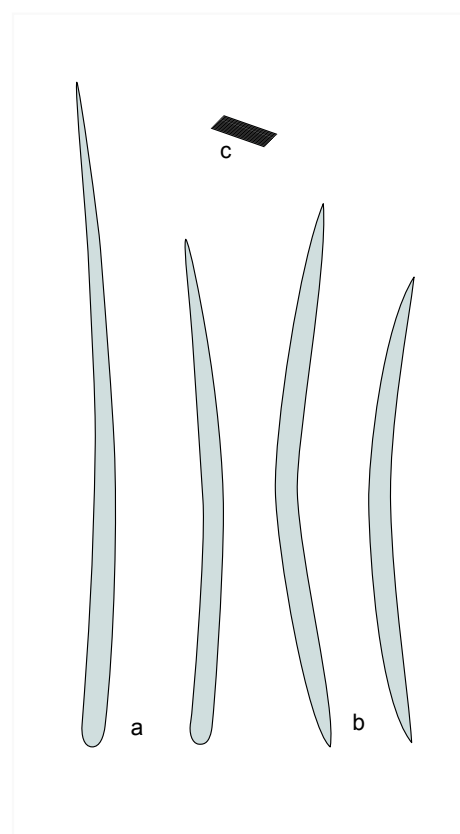

	being a rarity in Axinellids). Dense axial skeleton may be absent; extra-axial reticulation may be completely replaced by plumose fibres.)
Spicules	Megascleres are styles (a) 260-(330)-360µm and oxea (b) 210-(250)-280µm (slightly curved) and occasionally strongyles. Microscleres are trichodragmata (c), longer than those of <i>Axinella dissimilis</i> but often inconspicuous.
Voucher	BELUM : Mc1530. Ardnoe Pt, Sound of Jura.
Habitat	“Shallow sublittoral to 630m.” Usually found on bedrock, cliff ledges, or stable boulders in the circalittoral zone, usually on horizontal surfaces in semi-sheltered conditions where it must be tolerant of the presence of sediment. Reported on “shells, gravel stones, sand or mud” but this may refer to dredgings from deeper water. (??)-confirmation of this would be valuable.
Distribution	“Norway; Faeroes; U.K.; North and East France.” Recently known from W. coasts of Scotland and Ireland; Anglesey; Lundy; etc where it is a common and conspicuous species in the right habitat. Apparently not found on North Sea coasts of the U.K., although a photographic record exists from off Northumberland. (Bamber & Coughlan, 1989)
Identity	A well formed cup with rounded edges, attached by a central stalk, is unlikely to be anything but <i>Axinella infundibuliformis</i> . However a few other rarer species form cups so identification should be confirmed by microscopic examination. <i>Phakellia ventilabrum</i> (q.v.) is one such species, distinguished by possessing long flexuous (vermiform) styles (not straight or slightly curved ones). <i>Phakellia ventilabrum</i> is said to have thin walls and a sharp edged rim to its cup, and also to differ in texture from <i>Axinella infundibuliformis</i> , being of a laxer consistency.
References	Arndt, 1935, p.90. Bowerbank, 1866, p.317; 1874, p.137 Hiscock, Stone and George, 1983 [1984], p.22.
Sources	S.M. Stone, (D. Moss, B. E. Picton).                      Editors D. Moss, B.E. Picton.

### ***Phakellia ventilabrum* (Linnaeus, 1767:1296)**

Family	AXINELLIDAE
Synonyms	None in common use.
Form	Cuplike or lamellate, attached by fairly narrow base i.e. sub-stipitate. Edge of cup/fan sharp, frayed, not neatly rounded, except in juvenile specimens.
Photographs	St. John’s Pt., Donegal. (B.E. Picton)
Colour	Grey, Also reported as “yellow, often with a green tint” (?). Confirmation would be valuable.
Smell	None
Consistency	Firm, elastic, fairly tough, but becomes laxer in older specimens, when it can become easily torn.
Surface	“Even.” Slightly velvety; no projecting spicules visible to naked eye. In cuplike forms, the interior of the cup is dotted with small openings which are larger than the openings on the outer surface. Both surfaces have a tendency to be marked by an ascending system of “vein-like” lines. In older specimens the surface can become wrinkled (i.e. rugose), especially towards the base.
Apertures	Exhalent openings (oscles) are confined to one surface; in cuplike forms seen as pin-hole sized openings scattered over the inner surface of the cup. Pores are not visible with the naked eye (?).
Contraction	None.
Skeleton	Plumose. An axial or mesial condensation of densely packed vermiform megascleres (i.e. flexuous spicules), with radially arranged ascending plumose fibres arising from the core and branching and anastomosing towards the surface. At the surface they form brushes. Minimal amounts of spongin encase the spicules.





Spicules	Megascleres are long, vermiform strongyles (a) 420-(525)-620 x 7.5µm forming the axial condensation, whereas the plumose fibres consist of styles (b) 220-(420µm)-500 x 7.5µm which are slightly curved at the base. "Styles may be supplemented or even replaced by oxea (c)". These are mostly anisoxea, with one end finely tapering and the other blunt or telescoped. No microscleres are present.
Voucher	BELUM : Mc449. St. John's Pt, Donegal.
Habitat	Slightly sheltered locations close to deep water. At St. John's Point, Donegal, at 30m on rock ridges. At Skird Rocks, Galway, characteristic of Konnecker's Axinellid association - <i>Axinella dissimilis</i> , <i>Axinella infundibuliformis</i> , <i>Diazona violacea</i> , <i>Eunicella verrucosa</i> , <i>Alcyonium glomeratum</i> .
Distribution	"Arctic, Atlantic coasts of Europe". Known recently from Ireland: the Aran Islands and Skird Rocks, Galway Bay; Donegal Bay; and W. Scotland: the entrance to Loch Sunart, Sound of Mull.
Identity	Similar to <i>Axinella infundibuliformis</i> but often larger, more brittle, with a sharp edge to the cup (rounded in <i>Axinella</i> ). Colour is grey, c.f. <i>Axinella</i> which is slightly brown to yellow. <i>Axinella</i> has trichodragmata and lacks vermiform megascleres. Other lamellate Axinellids recorded from British Isles include <i>Axinella arctica</i> Vosmaer, 1885:25. <i>Phakellia robusta</i> Bowerbank 1866:120 and <i>Phakellia rugosa</i> (Bwk 1862:770).
References	Arndt, 1935, p.90. Bowerbank, 1866, p.122; 1874, p.57. Könnecker, 1973, pp. 451-472.
Sources	B.E. Picton, S.M. Stone. <span style="float: right;">Editors D. Moss, B.E. Picton.</span>

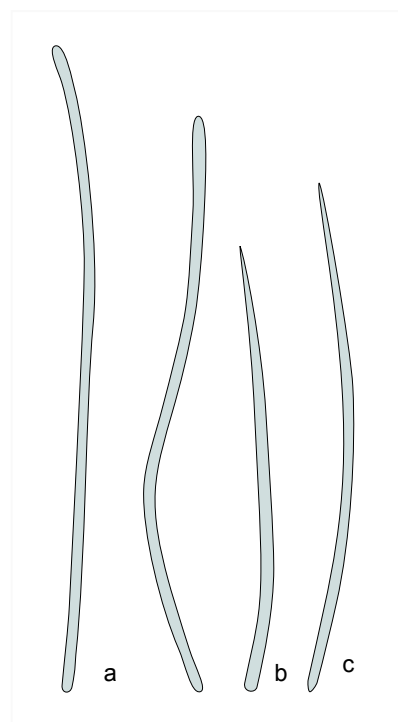

### ***Bubaris vermiculata* (Bowerbank, 1862: 229)**

Family	BUBARIDAE
Synonyms	<i>Hymeraphia vermiculata</i> Bowerbank, 1862: 141-143, <i>Bubaris vermiculata</i> Bowerbank, 1862: 141-143, <i>Hymeraphia vermiculata</i> var. <i>erecta</i> Carter, 1876: 307, <i>Axinella erecta</i> (Carter, 1876: 307).
Form	Thin sheets, up to 10cms across, often growing over barnacles. (? In erect form, "short, cylindrical, angular, club-shaped sponges, becoming massive, lobed, and lobulated, or compressed and expanded flabellately", up to 12cms in height).
Photographs	Skird Rocks, Galway. (B.E. Picton)
Colour	Wine red, "vivid red". (Greyish yellow in alcohol, light buff yellow when dried).
Consistency	Firm.
Surface	Uneven, finely hispid. With "depressions and elevations".
Apertures	Oscules minute. Pores "inconspicuous"; grouped in sieves according to Boury-Esnault and Lopes, 1985.
Contraction	? oscules contract on collection.
Skeleton	In crust form, styles echinate the sponge base, with their heads on the substrate, and their points projecting beyond the ectosome to give the hispid appearance. Vermiform spicules may be heavily concentrated at the base of the sponge, or dispersed throughout.



**Spicules** Styles (a) are slender, up to 3000µm in length (Arndt states 130µm, presumably in error). The vermiform spicules are oxea (b) and perhaps strongyles, that are robust, irregular and crooked; 280-600µm (?) in length. Microscleres are absent.

**Voucher** BELUM : Mc572. Skird Rocks, Galway.

**Habitat** On pebbles, and bivalve shells. The more extensive sheets develop on rock surfaces. Reported growing on deep water coral, and amongst beds of *Sabellaria spinulosa* at 60-70m.

**Distribution** Recorded from many parts of the Atlantic and Mediterranean. Off UK shores, recorded from the north of Scotland, Shetland and to the Faroe Islands. Recorded recently from Skird Rocks (Galway Bay), St. John's Point (Donegal) and Kenmare River (Kerry), in Ireland. Found from relatively shallow water (less than ca. 25m) to about 3000m.

**Identity** The crust form is difficult to distinguish from other red crusts by sight, but the vermiform spicules are characteristic. The erect form can be distinguished from other erect sponges by the presence of vermiform spicules, and from other species of *Phakellia* (which also possess vermiform spicules) by the more regular cup or lamellate shapes of the latter (see *Phakellia ventilabrum*, q.v.).

N.B. It is not certain whether there are two forms of *Phakellia vermiculata* that are ecologically (and genetically?) distinct, or whether a crust will eventually develop into an erect form. The former view has prompted the separation of the erect form into a variety (synonym 3 above) and a species (synonym 4).

**References** Arndt, 1935, p.87.  
Boury-Esnault and Lopes, 1985, p.171.  
Bowerbank, 1862, p.229; 1866, p.141; 1874, p.67; 1882, p.54.  
Ridley and Dendy, 1887, p.182.

**Sources** G. Ackers (D. Moss, B. Picton).

Editors D.Moss, B.E. Picton.

Draft 1 2/90

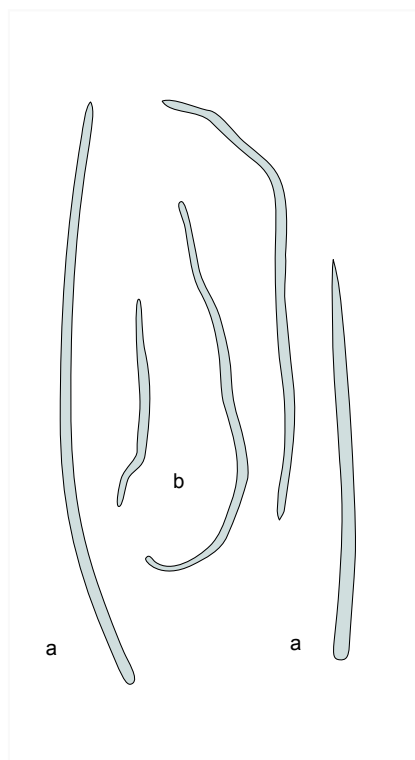

## *Ciocalypta penicillus* Bowerbank, 1864:180

**Family** HALICHONDRIIDAE.

**Synonyms** None in common use; for others see Arndt, 1935.

**Form** Very characteristic. The sponge consists of a basal cushion buried in sand or gravel, from which project large conical, translucent, ridged, thick walled, non-contractile papillae.

**Photographs** Banquette Bay, Sark Channel Isles. (B.E. Picton)

**Colour** White-cream to cream-yellow to grey (both cushions and papillae). Sometimes the base and papillae may be of different colours, the base being greyish yellow and the papillae translucent white? (This feature needs confirmation.)

**Smell** ? None (please check smell and report).

**Consistency** Basal cushions are moderately firm, moderately elastic. Most of the papillae can be bent through 180 deg. without breaking, although some do break. (Cf. *Polymastia* spp. in which none of the papillae break on bending to this extent.)

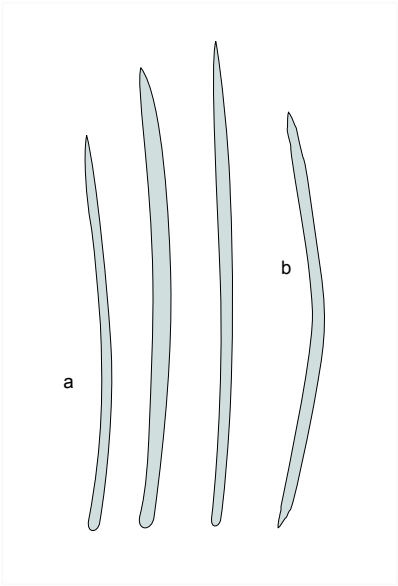

Surface	The surface of the papillae has a glassy, translucent appearance, through which vertical spicule fibres can be seen with the unaided eye. A central core is usually conspicuous in living material. These are responsible for the vertical ridges.	
Apertures	Oscules are on top of some of the papillae (which are therefore exhalent processes as well as inhalent - this contradicts the first edition of the photograph captions). The oscules can be seen only when the sponge is undisturbed underwater.	
Contraction	Not noticeable.	
Skeleton	Halichondroid. The main skeleton is an irregular reticulation consisting mostly of larger spicules, with a tendency to form ascending fibres. In the papillae there is a central condensation with radially arranged ascending fibres. The ectosomal skeleton is a tangential reticulation (sometimes very diffuse), with smaller spicules predominant. ?There may be sub-surface spaces . Spongin is scarce.	
Spicules	The spiculation is simple: smooth megascleres consisting of large and small slender oxea and styles. The styles (a) are incompletely differentiated into two size categories, 300-(370)-425µm & 500-(550)-610µm, and the oxea (b) 470-(550)-630µm. The spicules frequently have telescoped or distorted extremities. There are no microscleres.	
Voucher	BELUM : Mc548. Saltee Islands.	
Habitat	In clear water. Always with basal cushion buried in sand or gravel which may be covered by a layer of silt. The usual habitat of clean coarse sand with some gravel indicates a preference for a degree of exposure to wave action or tidal streams.	
Distribution	“European seaboard of Atlantic from Heligoland south to Spain, Portugal, Mediterranean, etc” Known recently from Coll & Tiree; Lundy; Skomer; Wexford; Donegal.	
Identity	May be confused with <i>Polymastia</i> , <i>Eumastia</i> and other papillate genera. The larger size and thick ridged walls of the <b>conical</b> papillae, some of which break if bent, and their glassy look, are very helpful features once learned. Also the papillae of <i>Ciocalypta</i> do not appear to contract or collapse as do those of <i>Polymastia</i> spp. In <i>Polymastia mamillaris</i> a network of spicule fibres can often be seen underwater in the papillae. The spicule fibres in the papillae of <i>Ciocalypta</i> are central and vertical and do not form an obvious net, but appear as a <b>central core</b> . <i>Pseudaxinyssa digitata</i> is a similar species living in the same sort of habitat but currently known only from the French side of the English Channel, and the Mediterranean Sea. It has lateral digitations on the much larger papillae.	
References	Arndt, 1935, p. 105. Hiscock, Stone and George, 1983[1984], p.25.	
Source	S.M. Stone, (B. E. Picton).	Editors D. Moss, B.E. Picton.

### ***Halichondria bowerbanki* Burton, 1930:489**

Family	HALICHONDRIIDAE
Synonyms	<i>Halichondria coalita</i> (Lamouroux, 1816:80). *
Form	Polymorphic, varying from a cushion to almost a branching-repent form. A cushion can give rise to oscular chimneys with oscules at the top or, more typically, to a profusion of simple, solid, tassel-like branches with the oscules mainly along their length (cf. <i>Halichondria panicea</i> ). In some sheltered localities the branches grow over other organisms and loop like bramble stolons, attaching to any suitable object they encounter.
Photographs	1. & 2. Lee's Wreck, Strangford Lough, Down. (B.E. Picton)

Colour Usually buff or cream, never green.  
 Smell Not obvious.  
 Consistency Soft and moderately elastic. Branches do not break even if bent through 180 deg. (cf. *Halichondria panicea*).

Surface Smooth or uneven, often with a translucence which enables the outline of some deeper structures to be seen. In a collected specimen the translucence and consistency are reminiscent of parchment. Surface spicules are sometimes more or less parallel and united into widely spaced fibres, or the spicules are arranged in no obvious order.

Apertures Oscules are “usually small”, (but see photo 59) and either at the tops of chimneys, whose shape is uneven, or along the sides of branches. Larger oscular chimneys (up to 1 cm tall) tend to have an ill defined translucent band running up one side. The apical termination of this band (canal?) contributes to the unevenness of the oscular rims (cf. *Halichondria panicea*).

Contraction Not noticeable.

Skeleton Halichondroid. The main skeleton is a confused reticulation of oxea of variable size with a slight tendency to form fibres 4 - 10 spicules thick. The ectosomal skeleton is typically a regular reticulation of similar spicules arranged tangentially, these either lying singly and parallel to one another, or formed into fibres: this regular arrangement can become confused and lost. The surface spicules help to reinforce a well-defined ectosomal membrane. Sub-surface spaces are not as well developed as in *Halichondria panicea*. Very small quantities of spongin are present.

Spicules Simple. Megascleres are slightly curved slender oxea only: 400-(500)-600 x 12µm, and 200-(253)-320 x 2.5µm. The spicules are rather more slender and show a wider size range than in *Haliclona* spp., with which certain forms of *Halichondria* may be confused. No microscleres.

Voucher BELUM : Mc150. Strangford Lough, Down.

Habitat On rock or other animals, even ascidian tests. It reaches its maximal development in harbours and estuaries, being very tolerant of muddy and brackish conditions where it tends to replace *Halichondria panicea*. (But there are reports of both *Halichondria* species occurring together in silty conditions, e.g. from Sussex.) *Halichondria bowerbanki* can be partly embedded in mud. *Halichondria bowerbanki* occurs typically from the upper infralittoral downwards, and is never (?) found on the shore. *Halichondria panicea* occurs from the shore to the lower infralittoral, rarely deeper.

Distribution “Arctic; Norway; Belgium; British Isles; France; Mediterranean.” A common species in the British Isles.

Identity The variable nature of *Halichondria bowerbanki* can make it very difficult to identify positively. The most likely confusion is with *Halichondria panicea*. The table with *Halichondria panicea* will help to separate the two species. Some growth forms are peculiar to one or other of the species and these are indicated. The growth of tassels in *Halichondria bowerbanki* seems to be a good character, but these are not present all year round. Frequently however, it is impossible to be certain to which of the two species a specimen belongs.

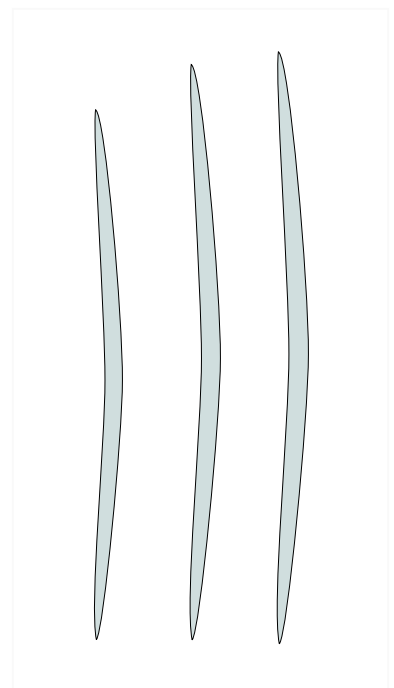

However larval differences prove that two species **are** involved here. The cushion forms, with modest oscular chimneys, can be mistaken for *Myxilla incrustans* (q.v.). The confusion arises when a specimen of *Halichondria bowerbanki* has an 'open' sub-surface appearance, which is reminiscent of the labyrinthine channels of *M. incrustans*.

References Arndt, 1935, p.102, as *Halichondria coalita*. See also references for *Halichondria panicea*.  
Hartman, 1958a, pp. 24-36, 102.

Sources S.M. Stone, (B.E. Picton, G. Ackers).

Editors D. Moss, B.E. Picton.

### ***Halichondria panicea* (Pallas, 1766:388)**

Family HALICHONDRIIDAE

Synonyms This very polymorphic species has given rise to a long list of synonyms which is now under review. It may be decided to re-establish some of these names, especially when they refer to distinctive forms, in order to encourage the collection of more information about the living animal. Names still in use on the continent include *Halichondria membrana* (Bwk., 1866:165) and *Halichondria topsenti* de Laubenfels 1936 (new name for *Halichondria reticulata* (Bwk., 1861:159)).

Form Very polymorphic, varying from thin sheets, massive forms and cushions to branching-repent forms (eg. a 3-dimensional clump of anastomosing hollow branches). Prone to giving off stout branching processes which develop into oscular chimneys. At certain seasons of the year slender, almost filamentous, branching processes (the 'albescens' form of Bowerbank) are produced. The photographs indicate the diversity of form.

Photographs 3. Gob na H' Airde, St Kilda. (B.E. Picton)

Colour Green in well-lit sites owing to the presence of algae. Cream-yellow in shaded sites. "Ash-grey, brown or (rarely) brownish-red when alive."

Smell Distinctive, like freshly deposited kelp on the strandline. This smell, once learned, is of very great help in determining difficult cases. (*Halichondria bowerbanki* does not smell like this.)

Consistency Compressible, resilient but crumbly - i.e. when handled can readily break (both cushion and branching forms), until skeleton has become well consolidated. Branches break if bent through 20 degrees (this is helpful in separating it from *Halichondria bowerbanki* whose branches do not break.

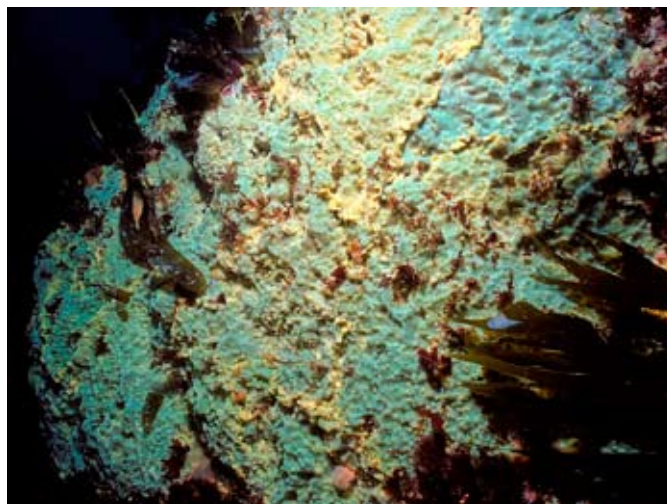

Surface	Usually smooth, often with a slightly glassy appearance especially when air is trapped below the surface in the sub-ectosomal system. Surface spicules are often united into fibres, which form a light regular net visible with the naked eye, although a x10 hand lens may be needed. This net is not always present. Even.
Apertures	Oscules are circular, raised on conules in the cushion form (eg. photo 4) and often regularly spaced; but are at the branch tips in the branched forms (photo 6), in addition to being sited along the branches. In some forms (? affected by currents) the oscules can be flush with the surface, or in lines on ridges. Oscular rims are of regular outline (?).
Contraction	Not noticeable.
Skeleton	Halichondroid. Main skeleton is a confused incipient reticulation of megascleres of variable size with little tendency to form ascending fibres and connecting branches. The ectosomal skeleton is typically a regular reticulation of tangentially arranged fibres of spicules which are similar to those of the main skeleton; but it can become confused. The spicules help to reinforce a well defined ectosomal membrane; the ectosomal fibres are 2 - 5 megascleres thick. A well marked system of sub-ectosomal spaces can be present, setting off the ectosomal skeleton from the confused interior. Very little spongin is present.
Spicules	Megascleres of slightly curved, slender, oxea only; typically 200-(265)-320µm long but can vary between 100 and 480µm. These are more slender and show a wider size range than those of typical <i>Haliclona</i> spp., with which certain forms of <i>Halichondria</i> might be confused. There are no microscleres.
Associations	This species frequently shelters many species of amphipods and annelids; over 50 species have been found in association with it in the Menai Straits, for example.
Voucher	BELUM : Mc109. Portrush, Co Antrim.
Habitat	An opportunistic species, found on the shore down to the circalittoral, which adapts to a wide range of niches. Usually on rock or any other hard substrate, e.g. crab carapaces, shells, etc. It sometimes grows profusely on the stipes of <i>Laminaria hyperborea</i> (in clean water habitats affected by tide and wave induced water movement); often well developed in tidal rivers and harbours. (? the faster the currents the better developed is the <i>Halichondria panicea</i> ?)
Distribution	“Arctic; Atlantic coasts of Europe; Mediterranean; etc.”
Identity	<b>Shore sheet form.</b> If the surface net is obvious, the colour is green, and it looks like the photograph then the identity is probably reliable. <b>Other forms.</b> Sections must be examined microscopically, and even then identification is not certain (smell is helpful). If the surface has a translucent quality (i.e. it is possible to see something of the underlying tissues through it), the surface spicule net is not obvious, the texture is pliable and the body skeleton is composed of spicules with a tendency to form bundles, then suspect <i>Halichondria bowerbanki</i> (q.v.). Other closely related species which should be considered when dealing with this <i>Halichondria</i> complex are <i>Halichondria (Topsentia) difficilis</i> (Lundbeck 1902:28), a deep water form with the distinctive characteristic of turning a deep purple on collection; <i>Halichondria agglomerans</i> Cabioch, 1968:226 and <i>Raspaigella (Spongisorites) genitrix</i> Schmidt, 1870:41. See Table on following page for differences from <i>Halichondria bowerbanki</i> .
References	Arndt, 1935, p. 103. Cabioch, 1968, pp.226-228. Graat - Kleeton, 1965, pp.166-174. Hartman, 1958a, pp30-36. Hiscock, Stone and George, 1983[1984],p.25. Vethaak, Cronie and van Soest, 1982,p.34.
Sources	B.E. Picton, S.M. Stone.                      Editors D. Moss, B.E. Picton.

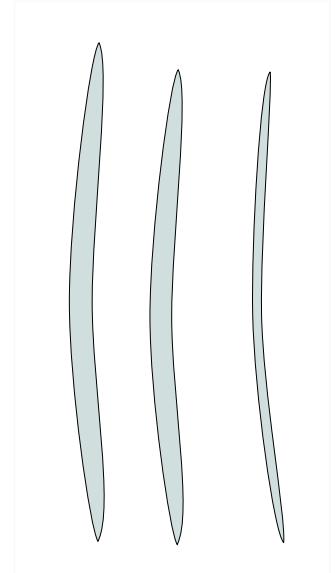

Table outlining the features of *Halichondria panicea* and *H. bowerbanki*

	<i>Halichondria panicea</i>	<i>Halichondria bowerbanki</i>
<b>Peculiar growth forms</b>	<p>1. Sheet with neat, round oscules, see photo 1.</p> <p>2. Anastomosing, hollow branches with oscules mainly at the tips, photo 6.</p> <p>3. Extensive smooth cushions on <i>Laminaria</i> stipes in current swept areas.</p> <p>4. Massive forms looking rather like <i>Pachymatisma johnstonia</i>, with oscules nearly flush with the surface.</p> <p>5. Massive forms, growing in areas subject to fast currents, with oscules in linear series along ridges, as in photo 5.</p>	<p>1. Cushion from which arise thin tassel-like solid branches, with oscules along their sides. Oscules usually are difficult to see out of the water, eg. photo 45 (but note the form shown in photo 59).</p>
<b>Smell</b>	Distinctive.	Not noticeable.
<b>Consistency</b>	Moderately firm, breaking easily if bent.	Moderately soft, pliable.
<b>Colour</b>	Sometimes green (if well lit).	Never green (?).
<b>Surface</b>	Often with a well developed spicule net, although this may be absent. Not translucent.	Often without a spicule net, although does sometimes have one. Often slightly translucent.
<b>Subectosomal spaces</b>	Seen in vertical slice. Often well developed.	Seldom well developed.
<b>Skeleton of body</b>	Spicules usually in no obvious order, but may form fibres.	Spicules can form fibres, although usually not obvious.
<b>Spicule size</b>	Typical length 300-350µm.	Typical length 500-550µm.

As there is so much overlap several workers have tried to pin point one character which they consider most helpful in separating the two species. Both the translucence of the surface of *Halichondria bowerbanki* and the surface net of *Halichondria panicea* have been used. However both these features are unreliable. For the worker with access to fresh material, the difference in smell is probably the most reliable character, although even this must be treated with caution. Several characters need to agree before the identity of a specimen can be reasonably certain.

## *Hymeniacidon perleve* (Montagu, 1818:86)

Family HYMENIACIDONIDAE

Synonyms *Hymeniacidon sanguinea* (Grant, 1826:135), *Halichondria caruncula* Bwk., 1866:166.

Form Thin sheets, cushions, to massive-flanged, rarely branching-erect. More than one form can be detected in the intertidal and shallow sub-littoral. It is possible that these may eventually be recognized as including more than one distinct species.

(a) Thin sheets, fully exposed on lower shore up to mid-tide level. Gains some shelter by growing along crevices and fault-lines and lying at the base of right-angled rock. Protective cover (e.g. algal canopy) is usually non-existent, with adjacent surfaces clean and dry. The only protection the animal seems to have is derived from (?) symbiotic algae living in the surface layers, causing a discolouration of the surface to a dull greenish-orange (deeper layers of body are a typical bright orange). Surface is even, smooth to minutely tuberculate.

(b) Cushions, half-exposed at LW and in the sublittoral fringe, favouring angles in rock and *Laminaria* holdfasts. Conditions generally muddy with a layer of fine muddy silt smothering the animal. When brushed aside, the colour is seen to be a clear pinky-orange. Surface even but distinctly tuberculate.

(c) Massive-flanged forms sometimes seen on the lower shore and in sublittoral fringe where conditions are distinctly muddy (e.g. estuaries and harbours) with fast-flowing currents. The animal can be overlooked as it is buried in the mud with only the tips of the flanges or oscular chimneys showing. Underneath, the colour is seen to be a deep dirty orange to brick red. Surface uneven, wrinkled, irregularly folded, with well-developed tubercles.

(d) In the sublittoral, cushions are generally found which can form large, spreading pinky-orange patches on hard substrates (e.g. rock) in semi-fast current areas (?).



Photographs Saltee Sound, Wexford. (B.E. Picton)

Colour “Yellow to orange to blood-red.” Shore forms tend towards blood-red, whilst sublittoral forms tend to be pinkish-red? Note the colour changes on preservation - the sponge goes patchily dark brown-black in alcohol. The degree of blackening depends (?) on the depth at which the individual grows, varying from no blackening for shore forms to an increasing blackening with depth. See also comments under ‘Identity’. This feature requires confirmation.

Smell Sweetish “sponge-like” smell.

Slime None.

Consistency “Firm, compact, compressible.”

Surface Various, “smooth, tuberculate, thrown into irregular folds, or else covered with branching processes”.

Apertures “Oscules scattered, level with surface or at top of branching processes.” Not conspicuous.

Contraction Not noticeable/slight.

Skeleton Halichondroid. Main skeleton disordered, a confused reticulation with a tendency to form ill-defined ascending fibres. Ectosomal skeleton is a tangential layer of spicules inter-crossing in all directions, or of brushes of spicules set vertically to surface. Spongin is scarce.

Spicules Simple, smooth styles. Megascleres are styles only: sometimes they are differentiated into 2 size categories in which case the smaller spicules are found mainly in surface layers. Occasionally there are tylote-like swellings at or near the rounded ends. There are no microscleres.

Voucher BELUM : Mc108. Portrush, Co Antrim. Littoral form.

BELUM : Mc612. Saltee Is., Wexford. Sublittoral form.

Habitat “On stones, rocks, shells, crabs and *Laminaria*.” A littoral and infralittoral (occasionally circalittoral) species. On the shore it is found on the sides of boulders, under weed; in damp places. Seldom exposed to direct sunlight (except in Loch Sween rapids).

Distribution “Arctic; British Isles; Belgium; France; Spain; Mediterranean etc.” Recently known from Tiree; Loch Sween; Menai Straits; Strangford Lough; Lough Hyne, Saltee Sound, Co. Wexford; Sussex; Solent; Lundy; Dyfed; Dorset; Jersey. A common species on shore and in the sublittoral. Not found on the East coast of Britain?

Identity B.E.P. recognises two forms : a shore form and a sublittoral form which differ as follows. Shore form: bleaches in alcohol, spicule length 230-(255)-280µm, [175-300µm]. Sublittoral form: turns dark brown in alcohol - this colour is not affected by sectioning and clearing. Spicule length 300-(375)-475µm, [200-400µm]. The form of the projections, tendency for the base to be silt covered and the pinkish hue to the colour are helpful in recognising the sublittoral forms. In silt-free conditions confusion is possible with *Crella rosea* (q.v.), which can occur in similar growth forms and colour. The spiculation is, however, quite different. If the forms (a)-(d) mentioned above prove to be consistent and widespread, it may be decided to re-establish some of the

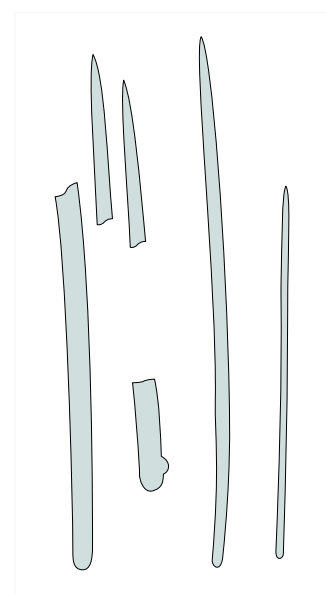



earlier names and treat them as separate entities for the time being, in order to encourage the collection of more information about the living animals. Another group of species to be considered, which have only styles for spicules, are *Rhaphidostyla* (*Stylotella*) spp., (see *Rhaphidostyla kitchingi*) but these can be distinguished by having unusually slender styles, typically forming wisp-like fibres running up to the surface.

References Arndt, 1935, p.105.  
Hiscock, Stone and George, 1983[1984], p.26.  
Stone, 1970, p.443.

Sources S.M. Stone, B. E. Picton, (G. Ackers, D. Moss). Editors D. Moss, B.E. Picton.

### ***Hymeniacion kitchingi* (Burton, 1935: 651)**

Family HYMENIACIONIDAE

Synonyms None.

Form Very variable. Thin sheets may have thin tassel-like outgrowths reminiscent of *Halichondria bowerbanki*, but are thinner. Encrusting forms resemble *Haliclona viscosa* or *Halichondria cinerea*, with lobate growths each with oscules. Tassel-like forms similar to *Iophon nigricans* have been observed in sheltered conditions.

Photographs MC519. Middle Calf Is., Roaringwater Bay, Cork. (B.E. Picton)

Colour Greyish beige, with a tinge of pink or purple.

Smell None.

Slime None.

Consistency Very soft, compressible.

Surface Smooth or rugose, or smoothly lobate, with a porous appearance similar to that of *Haliclona viscosa*.

Apertures These may be the most constant feature of the external appearance of this species. The oscules have a raised transparent rim with a few converging transparent excurrent canals. The oscular rims may develop short tassels reminiscent of *Amphilectus fucorum* (q.v.). However, in thinly encrusting specimens the oscules may not be apparent.

Contraction Oscules become inconspicuous on collection.

Skeleton Slender styles often forming wisp-like bundles running towards the surface; otherwise somewhat irregularly arranged.

Spicules Slender styles, often flexuous, typically ca. 220µm x 3-6µm. According to Burton, distal ends narrow to a point in semi-discrete steps - this feature is not visible in all specimens, and occurs in only about 10% of spicules in most specimens.

Voucher BELUM : Mc617. Ard Bay, Galway.

Habitat On rock, algae, bryozoans such as *Cellaria* and *Pentapora*, etc, in sites sheltered from wave action, but with moderate tidal streams. Infralittoral.

Distribution Recently reported from Shetland, W. coast of Scotland, Ireland, probably not uncommon.

Identity Very thin styles (with distinctive narrowing to the point), together with soft texture, lack of microscleres or other types of megascleres, and halichondroid skeleton, are the best distinguishing features.

Reference Burton, 1935, p.651.

Source D. Moss, B.E. Picton. Editors D. Moss, B.E. Picton.

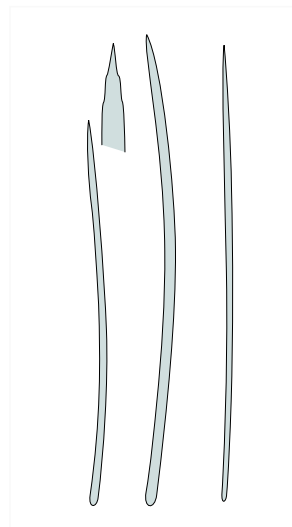

***Ulosa digitata* (Schmidt, 1866: 10)**

Family HYMENIACIDONAE

Synonyms *Chalina inornata* Bowerbank 1874: 277,  
*Desmacidon pannosus* Bowerbank 1874:  
312, *Stylotella inornata* (Bowerbank 1874).Form Massive-lobose, frequently extremely  
irregular and untidy in outline; crust or  
irregular cushions. Size varies from one or  
two to 10 or more cm in diameter.

Photographs

Colour Frequently yellowish, else a distinctive pinky  
orange or salmon pink (Methuen codes 7Ab  
and 7A7); seldom red.

Smell None.

Slime Surface is slimy.

Consistency Very soft, limp, easily compressible,  
somewhat elastic.Surface Uneven, often with irregular folds. Conulate,  
with the ends of fibres sometimes protruding  
from the conules, giving a somewhat hispid  
appearance. Foreign bodies are often  
incorporated into the surface (and may also  
be found throughout the skeleton fibres).  
Moderate friction.Apertures Oscules are irregularly dispersed and few  
in number. They tend to blend in with the  
generally ragged appearance of this sponge  
and so are not always obvious. Their rims are  
more or less raised, with ragged edges. Sizes  
range up to 1cm diameter, but are usually  
smaller. They remain open on collection and preservation.

Skeleton An isotropic reticulation of spongin fibres cored with styles. The primary fibres extend to the periphery, the secondaries interlink the primaries. The primaries are ca. 30-100µm in width, and are always polyspiculate with spicules compacted together along the fibre axis. The secondary fibres are ca. 20-30µm wide and are poorly spiculated, hence consisting mostly of spongin. Further slender spicules may be sparsely scattered outside the fibres. Foreign bodies may be found within the primary fibres. The ectosomal skeleton consists of fine spongin fibres which may lack spicules.

Spicules The spicules are styles which can be classified into “robust” and “slender” categories. The former are ca. 170-(220)-260 x 7-10µm. The “slender” styles are ca. 110-235 x 2-3µm, and may occasionally be styloid or oxeate.

Voucher BELUM : Mc1774. Skomer Is., Wales

Habitat In wave-sheltered locations in the infralittoral, frequently growing on or around algae or sessile/encrusting animals.

Distribution A southern species: Plymouth, Channel Islands, Skomer, Isle of Man, Roscoff, Azores.

Identity This species is similar in overall appearance to *Dysidea fragilis* (q.v.), but it may be distinguished in the field by colour, a more ‘ragged’ appearance, its softness, and the absence of oscular ridges. In a section the spongin skeleton cored by styles is distinctive. *Acervochalina limbata* (q.v.) similarly grows on seaweeds, but is smaller, has a more regular outline and is confined to the shore; its skeleton consists of fibres cored with oxea. With experience, *Ulosa digitata* is quite easy to identify in the field.References Arndt, 1935, p.56.  
Topsent, 1899, p.107.

Sources G. Ackers, W.C. Jones (B.E. Picton). Editors D. Moss, B.E. Picton. Draft 1 2/90

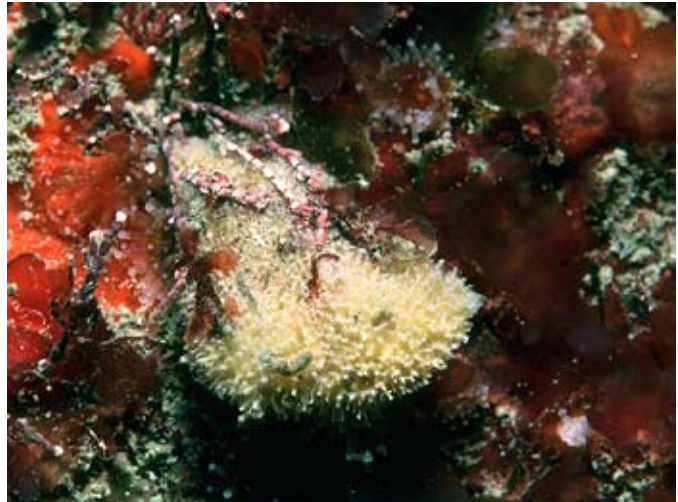

***Tethyspira spinosa* (Bowerbank, 1874)**

Family RASPAILIIDAE

Synonyms *Tethea spinosa* (Bowerbank, 1874: 279).

Form Low cushion with tall sides and rugose upper surface. Larger specimens may become massive-globose, to ca. 15cm across, and are often angular with ridges and crests. (Cushion forms are also described in the literature, and Arndt (1933) refers to a crust-like form).

Photographs

Colour Greyish-white, through orangeish, to almost rose-red. The colour can vary within a single specimen, because of the variable combination of a translucent whitish ectosome and light brown choanosome.

Smell None reported.

Slime None, although surface is somewhat slippery.

Consistency Firm; slightly compressible, elastic.

Surface Slippery. Conulate, rather 'spiky' in appearance, due to ends of spicule bundles raising and sometimes penetrating the surface. "Sticky" appearance: subsurface channels sometimes visible in photographs.

Apertures *In situ*, oscules are usually borne on long, white, translucent, almost vermiform chimneys. These are not always present, but there may be two or three per sponge. They are fragile and collapse on collection, leaving whitish patches.

Contraction Noticeable but slight, with contraction of the ectosomal layer being more marked than that of the choanosome.

Skeleton Parallel fibres of long styles (sometimes subtylostyles) are present; these are less closely distributed near the surface, where they become separated by spongin. Some spicules penetrate the surface. There is a scattered basal layer of small acanthostyles of characteristic shape, with long spines. These are easily missed as the basal layer of massive sponges is not always collected or sectioned.

Spicules The main structural megascleres are straight or somewhat curved styles or subtylostyles (a), up to 1-2mm long x 3-12µm thick. Long-spined microtylostyles (b), ca. 70-120 x 4-6µm, are also present in a basal layer, but may be scarce and hard to find.

Voucher BELUM : Mc1581. Rathlin Is. Antrim.

Habitat On wave exposed circalittoral rock (often where horizontal when in the "open"), to at least ca. 60m.

Distribution A south-western species in the British Isles. Known recently from Salcombe (Prawle Point), Lundy, Skomer, Sherkin Is., Calf of Man, Rathlin Is. (The record of *Rhaphidostyla incisa* reported by R.W.B. van Soest from Sherkin Is. (Irish Nat. J. 20, (1), p. 1-15), was found on re-examination to be *Tethyspira spinosa* (R.W.B van Soest, pers. comm.)). Reported from Fowey Harbour by Bowerbank. "Continental Channel coast", ?Brittany.

Records from other sites in the British Isles would be of very great interest. **Do not over collect.**

Identity At a casual glance the surface is rather reminiscent of *Dysidea fragilis* (q.v., the skeleton is, of course, completely different). The translucent, waxy appearance is somewhat like that of *Haliclona fistulosa* (q.v.), but the latter has a brittle ectosome, produces fistules and has a quite dissimilar spiculation. With experience, this is an easily recognisable species. The identity may be confirmed by the skeleton and especially by the

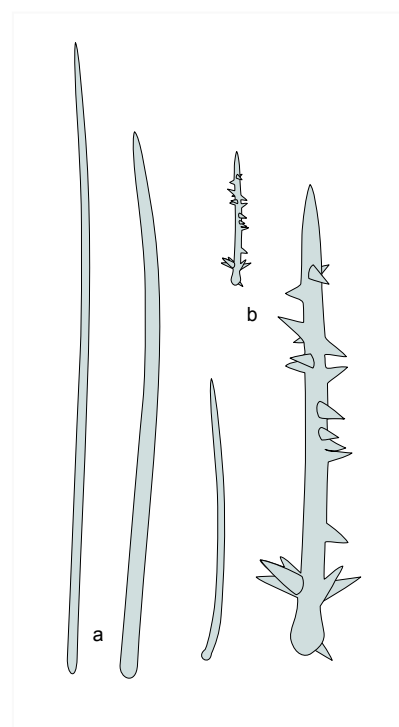

shape of the basal acanthostyles.

References Arndt, 1935, p.86.  
Bowerbank, 1874, p.279.  
Hiscock, Stone and George, 1983 [1984], p.25.  
Topsent, 1900, p.257.

Sources D. Moss, B. Picton (G. Ackers). Editors D. Moss, B.E. Picton.  
Draft 1 3/90

### *Haliclona angulata* (Bowerbank, 1866:233)

Family CHALINIDAE

Synonyms *Gellius angulatus* (Bowerbank, 1866). See also de Weerd, 1986.

Form Irregular cushion with tendency to form outgrowths, which may be mushroom shaped, fistulose or irregular in shape.

Photographs BELUM: Mc61. Gurley Rock, Padstow, Cornwall. (B.E. Picton)

Colour Pale pink/grey.

Smell None.

Consistency Firm, crisp and somewhat brittle.

Surface Even, translucent, porous; slightly hispid, sometimes shaggy.

Apertures Oscules are not conspicuous.

Contraction None.

Skeleton "The ectosome is a regular and characteristic, open, isotropic reticulation of intercrossing oxea. The choanosome is a rather confused, sub-halichondroid reticulation, in places consisting of paucispicular primary and unispicular secondary lines, in places multispicular tracts. There is very little spongin, confined to the nodes of the spicules, or absent."

Spicules Long thin oxea (a) with long, rather sharp points, 250-350 x 3-14µm. Toxa, (b) very slender, sharply bent, with recurved apices, 43-75 x 0.2-2.5µm. Sigmata, (c) strongly curved, somewhat accolada-shaped, small, 7-15 x 0.2-1.2µm.

Voucher BELUM : Mc1358. Longue Pierre, Guernsey, Channel Is.

Habitat On rocks in exposed places. (?)

Distribution A southern species in the British Isles, not uncommon on the south coast, in the Scilly Isles and Channel Isles. Known from Gurley Rock, near Padstow, N. Cornwall.

Identity The presence of the characteristic microscleres in a renieroid skeleton is very distinctive. More observations are needed to see if the external appearance is always characteristic. *Haliclona rava* (Stephens, 1912) (q.v) is very similar but differs largely in the size of the oxea and shape of the toxa. *Haliclona fibulata* (q.v) is similar in spiculation but lacks toxa. Several genera have been established in the past for different microsclere combinations, e.g. *Gellius* for sigmata and toxa; *Sigmatocia* for sigmata only; and *Toxadocia* for toxa alone. All are recognized as being artificial and are abandoned here in line with de Weerd, 1986.

References de Weerd, 1986 p.132.  
de Weerd, 1987[1990], p.87.

Sources B.E. Picton, S.M. Stone.

Editors D. Moss, B.E. Picton.

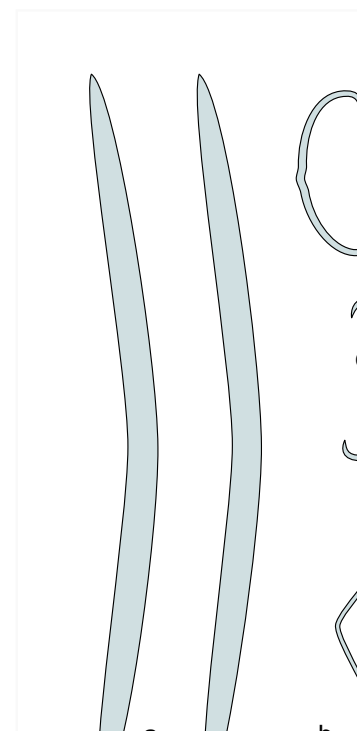

***Haliclona cinerea* (Grant, 1826: 204)**

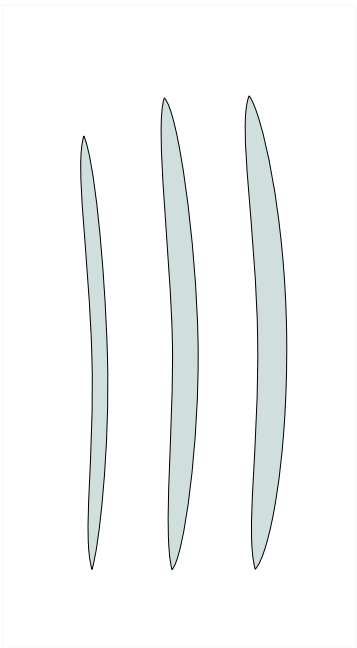
Family	CHALINIDAE	
Synonyms	<i>Isodictya cinerea</i> Bowerbank, 1866:274; <i>Halichondria montagui</i> Fleming, 1828:522; <i>Isodictya peachii</i> Bowerbank, 1866:276; <i>Isodictya elegans</i> Bowerbank, 1866:283	
	See also de Weerd, 1986.	
Form	Varies from thinly encrusting patches to smoothly rounded lobes to tall, chimney-like growths with large terminal oscules or laterally spreading masses of anastomosing branches. The shape of this species is highly variable.	
Photographs	Lee's Wreck, Strangford Lough, Down. (B.E. Picton)	
Colour	Grey-brown to purple-brown, evenly coloured over all of the sponge. The purple-brown form may be characteristic of better illuminated sites in shallow or clear water. Goes whitish in spirit (?consistently).	
Smell	?	
Slime	None obvious, but slime strands appear when the sponge is pulled apart.	
Consistency	Very soft and flexible - one of the softest <i>Haliclona</i> species.	
Surface	The surface layer is not apparently differentiated from the body of the sponge. It is smooth, and on close examination is seen to consist of a loose network of tissue with irregular spaces between the strands, giving a characteristic, 'loosely woven' appearance.	
Apertures	The oscules are terminal on raised lobes, or at the ends of tall chimney structures. The oscules are flush with the rounded ends of these chimneys, and do not have a raised membranaceous edge as in many other <i>Haliclona</i> species.	
Skeleton	Ectosomal skeleton is a regular six-angled unispicular reticulation of single spicules bound at the nodes by a variable amount of spongin. Choanosome is a loose network with thin unispicular tracts and a reticulate linking skeleton of single spicules. Spongin reinforces the joints between spicules but may vary considerably in amount. When it is abundant the skeleton may become more irregular.	
Spicules	The spicules are short and fat oxea, abruptly pointed, often with strongylote or stylote modifications, 80-130 x 4-8µm. There are also thin developmental oxea, both incorporated into, and outside of, the reticulate skeleton.	
Voucher	BELUM : Mc1409. Carna, Galway.	
Habitat	Frequent in water 10-30m deep in moderately exposed sites, and also in sites which are sheltered but have moderate tidal streams. The tall chimney-like form only develops in the more sheltered conditions. Also present in very shallow water and under stones in the intertidal.	
Distribution	Widespread in Ireland; W. coast of Scotland; English Channel. "Shetland; France; Mediterranean; Azores; West Africa."	
Identity	The slime strands when the sponge is pulled apart appear to be the most consistent and characteristic unique feature of this species. The smoothly rounded appearance of the oscular chimneys, when present, differentiate it from the other species with oscular chimneys, such as <i>Haliclona viscosa</i> , where they are rugose. Spicule size and shape aid separation from <i>Haliclona rosea</i> , which can look similar. Finally the white coloration in alcohol may prove to be a useful character.	
References	Jones, 1987 p.109. de Weerd, 1986 p.104. de Weerd, 1987[1990], p.80.	
Source	B.E. Picton, (W. de Weerd).	Editors D. Moss, B.E. Picton.

***Haliclona fibulata* (Schmidt, 1862)**

Family CHALINIDAE

Synonyms *Reniera fibulata* Schmidt, 1862, *Gellius fibulatus* (Schmidt, 1862) Topsent, 1890: 201; de Weerd, 1986.

Form Cushion, up to 10cm across, “occasionally with fistular proliferations”.

Photographs

Colour Pink-pale rose, greyish-rose; becomes creamy in alcohol.

Smell Slight marine “perfumed” smell.

Slime

Consistency Quite firm but compressible. Rather crumbly, especially in alcohol.

Surface Fairly smooth, with distinct reticulation showing through. Heavily punctate.

Apertures Oscules scarce, 1-2mm diameter; flush with surface and not very noticeable.

Contraction Not noticeable.

Skeleton The interior is an irregular net, basically of few-spiculed primary tracts with single spiculed secondaries, but the many ‘loose’ oxea give a distinctively confused appearance. The ectosome is an irregular and confused subisotropic reticulation. A little spongin is present at some nodes.

Spicules Straight or slightly curved oxea (a), with rather long and sharp points, 160-270 x 5-11µm. Sometimes a few strongylote and centrotylote modifications are found. Weakly curved sigmata (b) are present, ca. 10-37µm. These may be quite rare in some specimens and numerous in others.

Voucher BELUM : Mc789. DM 218. Raven’s Point, Anglesey. Coll. D. Moss.

Habitat From the upper sublittoral to ca. 60m in the sublittoral. “On stones, conglomerates of shells, calcareous algae, sponges etc.” In W. Anglesey it is only found growing over massive specimens of *Stelletta grubii* (q.v.), where it is quite common.

Distribution “British Isles, Atlantic coasts of France, Mediterranean, ?áSpitzbergen”. Known recently from Anglesey, Lough Hyne, N.áCornwall, Padstow.

Identity The colour in a cushion together with the spiculation is quite distinct in the larger specimens, but may be less reliable as a field characteristic in smaller. Microscopically, the renereoid skeleton with **only** sigmata as microscleres is characteristic. The sponge appears to be relatively uncommon, and more records would be welcomed.References Topsent, 1925, p.706.  
de Weerd, 1986, p.137.

Sources G. Ackers, D. Moss.

Editors D. Moss, B.E. Picton.

Draft 1 3/90

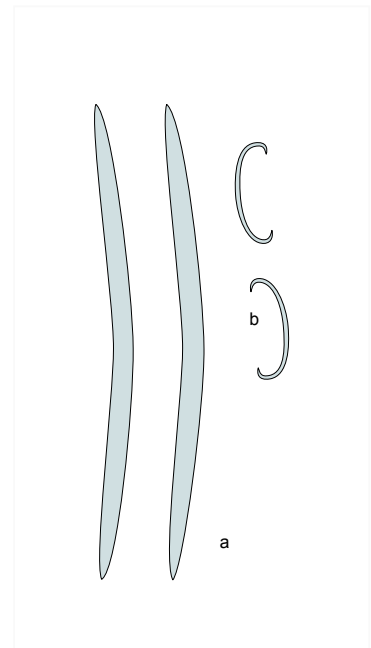
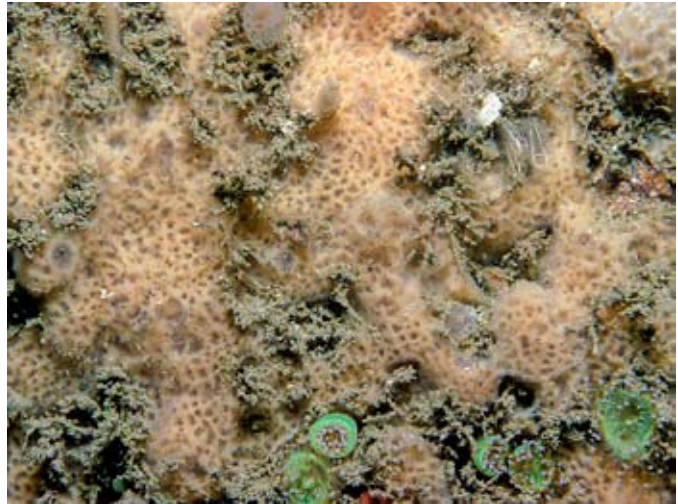
***Haliclona indistincta* (Bowerbank, 1866: 290)**

Family CHALINIDAE

Synonyms The generic names *Isodictya*, *Reniera* and *Adocia* have all been used for this species.

Form Thin sheets to cushions, forming patches from a fewcms to 20-25cm across.

Photographs W. Clifford Jones, Menai Strait, Wales.

Colour	Greenish brown, pinkish white.
Smell	None reported
Slime	None reported
Consistency	Softly friable.
Surface	Strongly punctate, slightly irregular and shaggy, with clearly visible exhalent canals converging on the oscules.
Apertures	Oscules are few, irregularly scattered, not or only slightly elevated; circular 1.5-3mm diameter.
Contraction	None reported
Skeleton	There is no ectosome. The choanosomal skeleton is a close meshed isotropic reticulation, with multispicular (ca. 3-9 spicules wide) primary and unispicular secondary tracts. Other spicules are randomly scattered. There is very little spongin, confined to the nodes.
Spicules	Megascleres are rather slender, fusiform oxea, 110-150 x 3-7.5µm. Microscleres are absent.
Voucher	
Habitat	Found mainly on the undersides of intertidal boulders.
Distribution	Known from Strangford Lough, south and west coasts of Ireland, Hastings, Dorset, N. Cornwall, Anglesey, Orkney, Roscoff.
Identity	A renieroid skeleton without an ectosome, with multi-spicular primary bundles, in an encrusting soft shore sponge with oscular channels is diagnostic for this species. Apparently, however, its name was not given lightly!
References	Arndt, 1935, p.94. de Weerd, 1986, p.129.
Source	G. Ackers (W.C. Jones).



Editors D. Moss, B.E. Picton.  
Draft 1 3/90

### ***Haliclona rava* (Stephens, 1912: 22).**

Family	CHALINIDAE
Synonyms	<i>Gellius rava</i> Stephens, 1912.
Form	Thin sheets, up to 6cm (maybe more) across and 13mm thick.
Photographs	W. Clifford Jones, Menai Strait, Wales.
Colour	Greyish yellow.
Smell	None reported
Consistency	Soft, somewhat fragile, but not friable.
Surface	Even, smooth (? may sometimes be slightly granular?)
Apertures	Oscules more or less level with the surface; small. Osculiferous processes may sometimes occur.
Contraction	None reported



Skeleton	Irregularly disposed oxea constitute a confused tangential reticulation in the ectosome. The choanosomal skeleton is somewhat confused, with irregular primary lines consisting of a few spicules, and unispicular secondary lines. There are also many randomly scattered single spicules.
Spicules	The megascleres are slender oxea with long, sharp points, ca. 130-260 x 5-11µm. The microscleres are irregularly bent, very small, sigmata, usually ca. 8 x 0.5µm (although a wider range of lengths may be present) and very slender toxa, the latter with a gently curved central flexion and slightly curved apices, ca. 40-120 x 0.5µm. Microscleres may sometimes be scarce.
Habitat	Possibly confined to the intertidal zone, under boulders.
Distribution	Recently known from Southern Ireland, Anglesey.
Identity	The small size, encrusting habit and renieroid skeleton <b>together with</b> the presence of both sigmata and toxa, separate this species from other British haplosclerids, with the exception of <i>Haliclona angulata</i> . (Note, however, that the microscleres may be scarce and difficult to detect). <i>Haliclona angulata</i> is more massive, translucent grey, “purplish and friable”, with larger oxea (ca. 200-350 x 3-14µm), and the toxa are characteristically strongly curved and shorter (ca. 40-75 x 0.2-2.5µm).
References	Stephens, 1912, p.22. de Weerd, 1986, p.141.
Sources	G. Ackers (W.C. Jones). Editors D. Moss, B.E. Picton. Draft 1 3/90

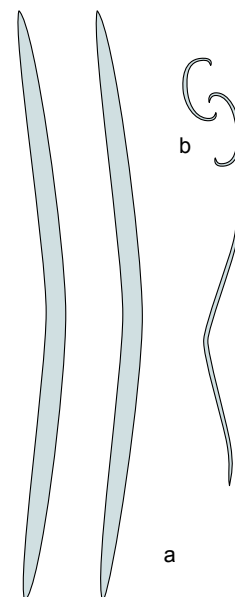

### *Haliclona rosea* (Bowerbank, 1866: 282)

Family	CHALINIDAE
Synonyms	This species has had a complex taxonomic history, with many synonyms; see de Weerd, 1986, p.122.
Form	The form varies from thin sheets, not exceeding 3cm across, to cushions up to 15cm across. In the larger specimens there are commonly a few thin, solid digitate processes branching from the main body.
Photographs	W. Clifford Jones, Menai Strait, Wales.
Colour	Varies from light brown to lavender purple. The colour vanishes entirely in spirit.
Smell	None reported
Slime	None reported
Consistency	Soft and fragile.
Surface	Even, irregularly punctate; slightly hispid from the presence of projecting spicules.
Apertures	The oscules vary from 0.5-2mm diameter in the thinly encrusting growth forms to 0.5 to 1cm in the larger and more massive forms. They may be flush with the surface, or be situated at the summits of chimney-shaped elevations.
Contraction	None reported
Skeleton	There is no ectosome. The skeleton consists of pauci- to multispicular (2-5 spicules wide) primary lines, connected by irregularly scattered, single, secondary spicules. The primary lines are often somewhat wavy. Spongin is scarce or absent; if present it is confined to the nodes of the spicule net.
Spicules	The megascleres are rather long oxea, with long points, 120-175 x 4-11 .
Habitat	Under intertidal boulders, and in the sublittoral to about 100m.
Distribution	Probably widely distributed all around the British Isles, except possibly the east coast of England. Known recently from Anglesey and Sherkin Island.





References de Weerd, 1986, p.122.

Source G. Ackers (W.C. Jones).

Editors D. Moss, B.E. Picton.

Draft 1 3/90

## ***Haliclona fistulosa* (Bowerbank, 1866:299)**

Family CHALINIDAE

Synonyms *Isodictya fistulosa* Bowerbank, 1866:299;  
*Isodictya macandrewii* Bowerbank, 1866:284;  
See de Weerd, 1986 for other synonyms.

Form Cushions to massive-lobose, with a tendency to throw out occasional, or many, fistulae and tassel-like extensions. These vary in length from short (usually fistulae), which give a warty appearance, to long (tassels), up to 4cm. The latter can anastomose with other tassels. The growth of the fistulae can be either vertical or lateral, and they are easily broken on collection. Narrow fistulae end 'blind', whereas wider ones possess terminal oscules. These may be borne on fistulae of any length (up to about 2cm), or can be flush with the surface of the main body, or possess rims. Oscules tend to be sparse. Specimens tend to remain compact, with a typical diameter of about 7cm, and height 2.5cm.

Photographs BELUM: Mc480. Rutland Harbour, Burtonport, Donegal. (B.E. Picton)

Colour The ectosome is translucent white; the interior tissue is brownish- orange or greyish-orange. The two in combination can cause specimens to appear to be off-white, greyish, or pinkish. The fistulae normally consist solely of ectosomal tissue, and so are translucent white.

Smell None, or very slight: difficult to describe ('fresh ozone', 'faint herbal', 'faint marine').

Slime None.

Consistency The ectosomal surface is brittle, crisp and quite hard, requiring high pressure before it 'gives'. The subdermal tissue is friable. As a whole the sponge is moderately to very firm.

Surface The surface layer is distinct, and peels off fairly easily. There are cavities below the ectosomal layer, in which air tends to become trapped on removal from the water, thus enhancing the translucent appearance. Minutely hispid, with moderate to high friction.

Apertures See under 'Form' for a description of the oscules. They are of varying diameter, up to about 0.75cm, and remain open on collection and preservation. They may be sparse, or even apparently absent in some specimens.

Contraction None.

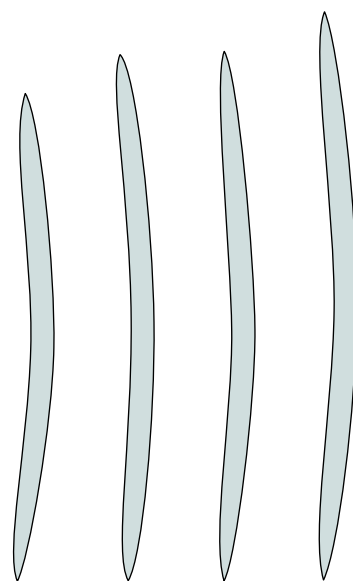
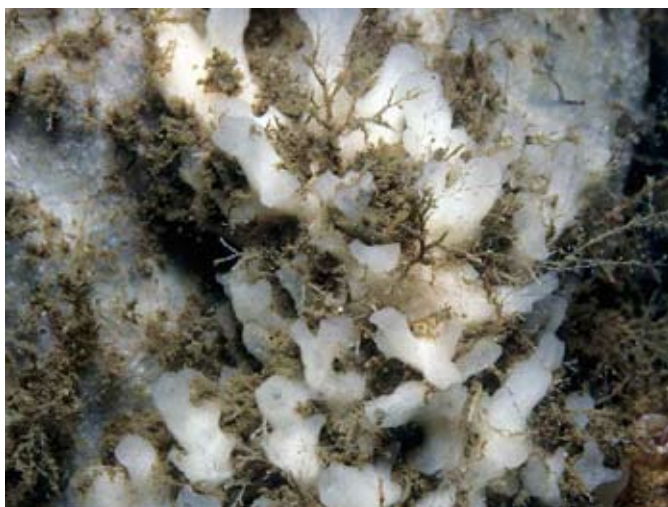

Skeleton	An anisotropic reticulation, regular and open in the surface layer, jumbled and dense in the interior. The tangential surface reticulation has triangular and square meshes, with sides unispicular in length and width. In the interior the primary tracts are 1-2 spicules in diameter, the secondaries are unispicular. Spongin is very scarce, confined to the nodes of the spicules.	
Spicules	The oxea are typically slightly curved, but may be straight, 140-200 x 6.5-9.5µm with a long, sharp point. There are also accessory oxea, 105-160 x 1-3µm, occasional in the surface layer, numerous in the interior.	
Voucher	BELUM : Mc480. Rutland Harbour, Donegal.	
Habitat	This sponge is found from the shore to the lower circalittoral. The orientation is variable, but it is more frequently found on vertical rather than horizontal surfaces. It is typically found in moderately sheltered, silty, areas with moderate tidal currents. According to GA, silt does not settle on the sponge, but BEP reports that the sponge may be covered by silt. Rather common.	
Distribution	Known recently from Strangford Lough, Down; Arranmore Island, Mulroy Bay, Donegal; Newquay, Galway; W. coast of Scotland; Ravens Pt., Anglesey; Lundy; Scilly Isles; E. Channel (Pullar Bank, Outer Mulberry, Shelly Rocks, Sussex).	
Identity	The fistulae or tassels, translucent crisp dermal surface, and whitish or pinkish colour are characteristic.	
References	Arndt, 1935, p.42 (as <i>Adocia fistulosa</i> ). de Weerd, 1986 p.109. de Weerd, 1987[1990], p.87.	
Source	G. Ackers, W. de Weerd.	Editors D. Moss, B.E. Picton.
	The descriptions are compiled largely from 14 specimens in the collection of G. Ackers. Other specimens may differ slightly in detail.	

### ***Haliclona oculata* (Pallas, 1766:390)**

Family	CHALINIDAE
Synonyms	<i>Chalina oculata</i> (Pallas, 1766:390); <i>Chalina arbuscula</i> Verrill & Smith, 1873.  See de Weerd, 1986 for other synonyms.
Form	Stalked and branching-erect. The branching is usually dichotomous, and the branches are simple or coalescent, cylindrical in cross-section. The exaggeratedly bushy, much-branched, forms seem to be typical of estuarine or strong current conditions. Under extreme conditions the coalescence of the branches may be almost total, leaving a fist-shaped form.
Photographs	
Colour	Usually pale yellow/beige, but lilac or pink forms have been reported (due to symbiotic algae?). New growths tend to be pinker.
Smell	None.
Consistency	Very soft and elastic near the branch tips, becoming firmer near the base. The base may, in older specimens, be very firm and elastic (never wiry). Unlike many other branched sponges, there is no strong central core to the branches.
Surface	Even textured, soft, and very slightly velvety, but not markedly velvety as <i>Axinella dissimilis</i> (q.v.).

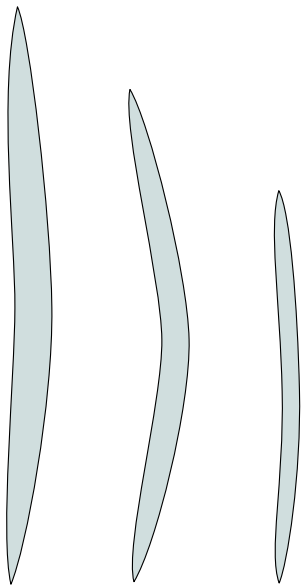

Apertures	The oscules are small (0.5 - 2mm diameter), round, neat, slightly raised, and remain easily visible even when the sponge is removed from the water. Usually serially arranged along the edges of the branches. Numerous.	
Contraction	Not noticeable.	
Skeleton	A regular anisotropic reticulation of spongin fibres. These surround singly or biserially arranged megascleres (short fat oxea), which form a single spicule network at the branch tips. The spicule fibres tend to be formed nearer the base, increasingly surrounded by quantities of spongin. "Quantity of spongin variable, increasing with age."	
Spicules	The spicules are short fat oxea 80-140µm long, usually less than 100µm in UK specimens; width 5-13µm. There are no microscleres.	
Voucher	BELUM : Mc528. Sherkin Is., Cork.	
Habitat	In sheltered but fast-moving water, rapids, estuaries, straits, where it can tolerate high levels of siltation. Also on vertical rockfaces in exposed open-coast conditions, where it usually forms single stick-like, unbranched colonies, or sparsely branched colonies.	
Distribution	"Arctic; British Isles", including North Sea coasts; "Atlantic coasts of Europe south to the Channel; etc." Known recently from the Menai straits, many channel coast locations, entrances to sea lochs in Scotland and Ireland, and offshore rocky sites.	
Identity	By eye alone, if very soft and elastic, with branches that are even in diameter with neat, round, easily visible oscules. The absence of a strong central core distinguishes <i>Haliclona oculata</i> from <i>Raspailia</i> and <i>Stelligera</i> (q.v.).	
References	Arndt, 1935, p. 100. Hartman, 1958a, pp. 52, 85. Hiscock, Stone and George, 1983 [1984], p.27. de Weerd, 1986, p.83. de Weerd, 1987[1990], p. 75.	
Sources	J.D. Guiterman, S.M. Stone, (D. Moss).      Editors J.D. Guiterman, D. Moss, B.E. Picton.	

---

### ***Haliclona simulans* (Johnston, 1842:104)**

Family	CHALINIDAE	
Synonyms	See de Weerd, 1986 for list (many).	
Form	Polymorphic sheets, thin cushions to branching-repent, with the branches frequently anastomosing. Grows from a basal crust which may spread across rocks.	
Photographs	Saltee Sound, Wexford. (B.E. Picton)	
Colour	Orange, beige, light brown. Boundaries between colour zones are typically sharp, a useful diagnostic character.	
Smell	None.	
Slime	None.	
Consistency	Hard, brittle, incompressible. Feels like a stick of wood.	
Surface	Smooth.	
Apertures	Oscules are regularly scattered along the branches, usually on small 'mounds'.	
Contraction	None.	

Skeleton	Surface skeleton is very regularly reticulated, unispicular; the interior is a dense polyspicular network, with considerable amounts of spongin present, especially at the nodes of the net.
Spicules	Short, fat oxea 120-150 x 5-12µm.
Voucher	BELUM : Mc1419. Brittany, France.
Habitat	In sheltered microhabitats although the site may generally be quite exposed, frequently with appreciable current. On boulder/bedrock, often bridging cavities/crevices in the rock.
Distribution	Known recently from north, south and east coasts of Ireland, including Strangford Lough; Anglesey; Devon, Jersey, Isle of Wight. Probably commoner in the south and west of the British Isles. Records from Scotland would be of interest.
Identity	The hardness, repent branching, neat arrangements of oscules which remain open when sponge is preserved, together with a typically Haplosclerid skeleton are, taken together, fairly distinctive.
Reference	de Weerd, 1986, p.97. de Weerd, 1987[1990], p. 78.
Sources	D. Moss, (S.M. Stone, W. de Weerd).      Editors D. Moss, B.E. Picton.

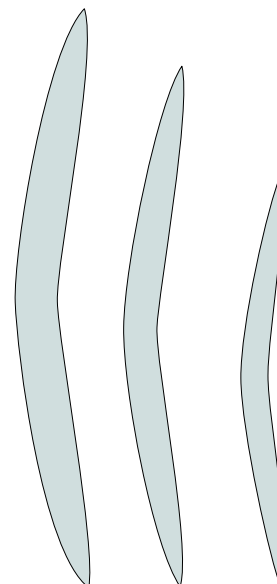

### *Haliclona viscosa* (Topsent, 1888)

Family	CHALINIDAE
Synonyms	See de Weerd, 1986.
Form	Variable, depending on microhabitat, but typically from spreading cushions with mamillate oscular chimneys, to massive lobose forms with tall, rugose, volcano-like oscular chimneys. These oscular chimneys tend to be arranged in irregular rows in cushion forms. The rows can become ill-defined ridges, caused by the oscular chimneys anastomosing for up to 3/4 of their height. In large forms the oscular projections can be mammiform, or chimneys, which become bulbous for the first 2/3 of their height, narrowing more sharply in the upper 1/3. The oscular rows may appear as tassels, or as repent branches (see van Soest, 1980, p.9). More information is required on growth forms, and their relationships with habitat types. Specimens may be large, with a spread of up to 30cm, and height to 5cm.



Photographs	SE Tearaght Is., Blaskets, Kerry. (B.E. Picton)
-------------	---

Colour	Typically purple, but can verge to pink or brown in some specimens. The colour is normally deeper on the higher portions of the sponge (i.e. oscular chimneys), becoming a washed-out fawn/grey away from the extremities. The depth of colour probably reduces with reduction in light intensity. van Soest & Weinberg (1980) report discolouration, from greyish-rose to violet tinges, on exposure to air: more information is needed. Other detailed colours recorded include reddish-like, greyish-ruby, greyish-magenta, greyish-orange and brownish-orange.
--------	--



Smell	None.
Slime	May be present in considerable amounts, especially when crushed or torn apart.
Consistency	Firm, compressible, friable.
Surface	Smooth and punctate (from the inhalant pores). Large specimens become rugose, caused by irregular tuberculate projections of variable size and position, giving a distinctive warty appearance. The projections can form surface ridges, giving the sponge an 'angular' appearance. Some specimens display an initially moderate friction, but quickly become slimy as pressure is applied.
Apertures	The oscules are formed on chimneys, as described under 'Form'. The openings are large, up to 1 cm in diameter, and remain open after collection and preservation. Inhalant pores show through the surface, and are closely packed and conspicuous.
Contraction	None.
Skeleton	Primary tracts are 3 to 6 spicules in diameter, with single inter-connecting spicules which are not differentiated into secondary tracts. There is no ectosomal skeleton. Spongin is scarce, nodal.
Spicules	Oxea, typically slightly curved, but varying from straight to fairly abruptly bent in the middle. 140 - 160 x 4.5 - 7µm. Larger oxea (up to 170µm?) are rare. Oxea in the range 95-140 x 1-5.5µm are occasionally found.
Associations	Amphipods may be found within the oscular openings.
Voucher	BELUM : Mc800. Strangford Lough, Down.
Habitat	This sponge is typically found from the upper circalittoral downwards, but less well developed specimens occur in shallower water and on the shore. It mainly occurs on vertical rock faces, in silt free areas of considerable water movement, e.g. gullies and/or areas exposed to wave action and tidal currents.
Distribution	Recently known from W. coast of Ireland; Northern Ireland (Antrim; Strangford Lough); W. coast of Scotland (Mull; Coll; Tiree; Oban; Lewis); S.W. Britain (Salcombe, Devon, Eddystone, Hard Deeps; Scilly Isles; Lundy).
Identity	The purplish colour, giant volcano-like oscules, rugose appearance and slime are characteristic. Less well developed specimens could be confused with other Chalinids.
References	van Soest & Weinberg, 1980. de Weerd, 1986, p.126. de Weerd, 1987[1990], p.83.
Source	G. Ackers, (W. de Weerd). <span style="float: right;">Editors D. Moss, B.E. Picton.</span>
	The descriptions are compiled largely from 11 specimens in the collection of G. Ackers. Other specimens may differ slightly in detail.

---

### ***Haliclona urceolus* (Rathke & Vahl, (in) Muller, 1806:42)**

Family	CHALINIDAE
Synonyms	<i>Isodictya clava</i> Bowerbank, 1866:316; <i>Chalina pulcherrima</i> Fristedt, 1885:49; "Stalked tubular <i>Haliclona</i> " This guide (Sponge IV).  See also de Weerd, 1986.
Form	Tubular, perhaps even bell shaped; with thin hard flexible stalk and terminal oscules. May have a single tube or several branches of the main stalk, or the body of sponge may branch; the branches may anastomose, and may be slightly flattened. Body to ca. 15cm long, with stalk typically less than half of the body length, proportionally more in smaller specimens.
Photographs	1. Geo Shunadal, Boreray, St Kilda. 2. Dysaghy Rocks, Achill Is., Mayo.
Colour	Beige, ?yellow?



Smell	None to 'slight spongy'.	
Slime	None.	
Consistency	Soft, flexible.	
Surface	Smooth.	
Apertures	Oscules are large, terminal.	
Contraction	Not noticeable.	
Skeleton	A rather irregular net, one or two spicules thick.	
Spicules	Oxea 110-155 x 3-7µm. Sizes may vary with geographical latitude, or water temperature.	
Voucher	BELUM : Mc647. Coll, Hebrides.	
Habitat	On rock, wreck, shell fragments etc. Found both in areas exposed to tide, and those with little water movement. Characteristic of vertical rock faces, but also can be found on more gently sloping surfaces.	
Distribution	Known recently from Rathlin Is; Skye; Tiree; W. coast of Scotland (Garvellachs, Easdale, L. Melfort, L. Fyne, L. Long, Clyde); Lundy; Skomer.	
Identity	Previously two species were thought to have been involved. " <i>Haliclona clava</i> " with erect, cylindrical, smooth tubes, and " <i>Haliclona urceolus</i> " with a softer, limper, consistency and more shaggy appearance. However the high degree of overlap between these forms convinced de Weerd of their synonymy.	
Photographs	90, 91.	
References	de Weerd, 1986, p.90. de Weerd, 1987[1990], p. 75.	
Sources	D. Moss, B.E. Picton.	Editors D. Moss, B.E. Picton.

---

### ***Acervochalina limbata* (Montagu, 1818: 111).**

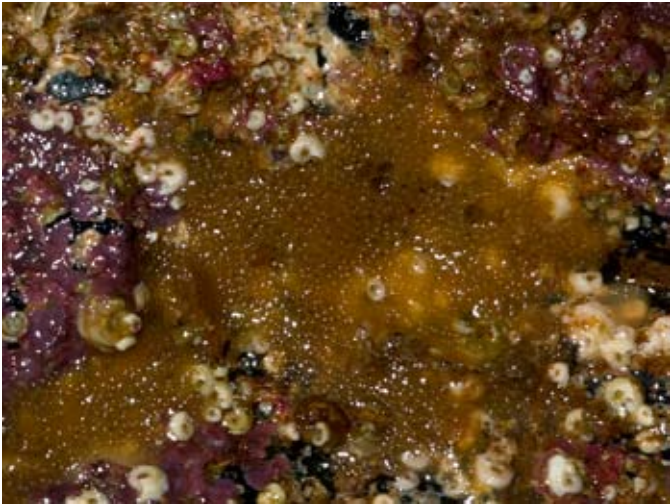
Family	CHALINIDAE	
Synonyms	<i>Haliclona limbata</i> (Montagu, 1818) Arndt, 1935, p.99. See de Weerd, 1986, p.145 for other synonyms.	
Form	Cushions, 1 to 3cm across.	
Photographs		
Colour	Brown.	
Smell		
Slime		
Consistency	Soft, elastic and tough; "lightweight" and spongy.	
Surface	Even, regularly and finely conulate.	
Apertures	Oscules are conspicuous, typically up to 3 in number, 1-3mm diameter. Normally flush with the surface, but the longer oscules may have a slightly elevated rim.	
Contraction	None.	
Skeleton	The skeleton consists of conspicuous fibres of spongin in an irregular reticulation. The fibres have a large width range, between ca. 5-120µm, and are sparsely to densely cored by oxea, some of which may be scattered outside the fibres.	

Spicules	The megascleres are oxea, 55-90µm by 0.5-1.5µm. In some specimens centrotylote swellings occur. They are much smaller than the oxea in most <i>Haliclona</i> species. There are no microscleres.
Voucher	BELUM : Mc375. Skye, Scotland.
Habitat	Found in the intertidal growing on brown seaweeds such as <i>Fucus</i> and <i>Cystoseira</i> : can also be found on stones.
Distribution	Probably occurs all around the British Isles, but is not well known. Known recently from Mull, Anglesey and Lough Ine.
Identity	The other two conulate species with which this species could possibly be confused are <i>Dysidea fragilis</i> and <i>Ulosa digitata</i> . Both these species tend to be larger, not confined to the shore, and possess coarser conules (the conules of <i>A. limbata</i> are very short and regular, giving the surface an almost hispid appearance). Both have skeletal fibres, but <i>Dysidea fragilis</i> does not possess spicules, and the fibres of <i>Ulosa digitata</i> are cored by styles, not oxea. With a little experience it should be possible to identify <i>A. limbata</i> in the field.
References	Arndt, 1935, p.99. de Weerd, 1986, p.145.
Source	G. Ackers.

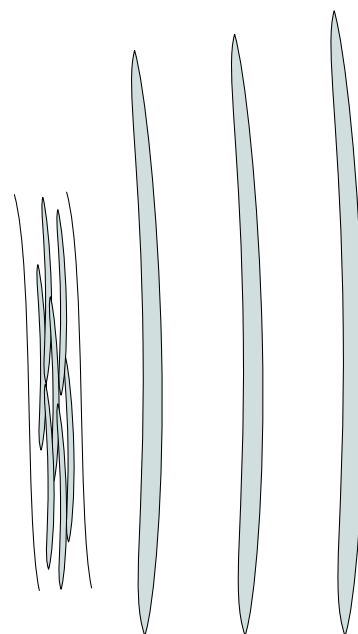

Editors D. Moss, B.E. Picton.  
Draft 1 2/90

### ***Dysidea fragilis* (Montagu, 1818:114)**

Family	DYSIDEIDAE	
Synonyms	None in common use.	
Form	Variable. Cushions to massive-lobose forms, usually less than 15 cm across, but can be over 15cm in tidal rocky estuaries.	
Photographs	Lee's Wreck, Strangford Lough, Down. (B.E. Picton)	
Colour	Usually whitish or grey but can be brown. In cases where sand grains predominate over organic matter the sponge can assume the colour of sand.	
Smell	None.	
Consistency	Variable. Usually moderately soft and fully elastic. The elasticity depends on the ratio of spongin (elastic) to inorganic matter. Usually tough.	
Surface	Smooth, conulate, because of spongin fibres lifting the surface layer. The projections are sometimes lighter in colour than the main surface. The surface may be slippery.	
Apertures	Oscules "scattered, variable in size".	
Contraction	Not noticeable.	
Skeleton	A reticulation of spongin fibres ( <b>not</b> a tree-like structure) partially or wholly obscured by foreign inclusions (in the cores of the spongin fibres and sometimes loose in the matrix), e.g. sand grains, spicules of other sponges, diatom valves, etc. The reticulation consists of stout ascending fibres with a secondary network connecting these main fibres. The spongin is not always visible, unless the section has been stained.	
Spicules	None of its own. 'Foreign' spicules may be incorporated into the skeleton - see above.	
Associations	The barnacle <i>Acasta spongites</i> forms a specific association.	
Voucher	BELUM : Mc70. Strangford Lough, Down.	
Habitat	On rock, maybe in crevices, widespread but seldom dominant (except in the Daucleddau estuary, Dyfed, and parts of the south coast). "On shell and gravel." Tolerates some silt.	

Distribution	“Arctic; Atlantic coasts of Europe; Mediterranean etc.” Recently from St. Abbs (rare), and many sites on the south and west coast of the British Isles.	
Identity	The conulate surface, great elasticity, coupled with the colour (whitish) are useful diagnostic features. If any of these features is absent then demonstration of the three dimensional spongin net, with inclusions, under the microscope is essential for confident identification. <i>Ulosa digitata</i> is a very polymorphic species, and in certain forms can superficially resemble <i>Dysidea</i> , even to the point of becoming loaded internally with sand grains. However <i>Ulosa</i> can be distinguished by always having styles coring the spongin fibres. <i>Dysidea pallescens</i> is a Mediterranean species occurring in Lough Hyne. It may well be found elsewhere. It is pink-purple in colour with relatively larger oscules.	
References	Arndt, 1935, p. 107. Hiscock, Stone and George, 1983[1984], p.28. Vacelet, 1959, p. 67.	
Sources	S.M. Stone, (B.E. Picton).	Editors D. Moss, B.E. Picton.

### ***Spongionella pulchella* (Sowerby, 1804).**

Family	DYSIDEIDAE	
Synonyms	None in common use.	
Form	Usually upright, occasionally branching, but normally a thick lamella as though branches have been webbed together. There is often a small stalked base attached to the rock. Also reported as small cushions.	
Photographs	E. of Doon Point, Rathlin Is., Antrim. (B.E. Picton)	
Colour	Yellow, greenish-grey, light buff, brown. Brownish when dried or in formalin.	
Smell	None.	
Consistency	Elastic, soft to fairly tough.	
Surface	There is a clear, easily detachable, dermal membrane. Surface is regularly conulate, corresponding to the ends of the skeletal fibres.	
Apertures	Oscules are 0.5-1.5mm in diameter, set in slight depressions. A few are scattered across the surface, with a closely spaced series of oscules at the outer edge of laminar specimens.	
Contraction	None.	
Skeleton	There are no spicules, but a regular lattice of spongin fibres. Thin (20-30µm) primary fibres radiate from the base towards the distal margins. The secondary fibres (ca. 7-20µm) lie approximately perpendicular to the primaries. Primaries are separated by ca. 200-350µm. The fibres do not enclose foreign bodies such as sand or ‘stray’ spicules. The fibres are stratified and the primaries possess a distinct ‘pith’.	
Spicules	None. Spongin fibre skeleton.	
Voucher	BELUM : Mc1471. Rathlin Island, Strangford Lough.	
Habitat	Usually on rock in deeper water and moderate to strong tidal streams. Also reported at the base of <i>Posidonia</i> (Mediterranean). Rather scarce.	
Distribution	North Atlantic (Greenland, Shetland, Ireland, Azores); Mediterranean. Recently recorded from the Northern Irish coast (North Channel) and the Sound of Mull.	
Identity	The form is somewhat reminiscent of some specimens of <i>Axinella dissimilis</i> (q.v.) with coalescent branches, or possibly <i>Haliclona oculata</i> (q.v.). However, it is easily distinguished from these by its colour, elasticity and oscules, combining to give a distinctive “giz”. In section, the lattice of spongin with no spicules is immediately diagnostic.	



References Boury-Esnault & Lopes, 1985, p.204.  
Bowerbank, 1866, p.359; 1874, p.167.  
Vacelet, 1959, p.52.

Source B.E. Picton (D. Moss).

Editors D. Moss, B.E. Picton.  
Draft 1 3/90

### ***Aplysilla sulfurea/rosea* F.E. Schulze, 1878:405.**

(Schulze could not decide whether these two colour forms were distinct species or belonged to the same species, because structurally they were very alike. He also thought that his *Aplysilla rosea* could be the same as *Verongia rosea* Barrois 1876. Vacelet, 1959, regarded them as a single species, but Bergquist, 1980, treats them as separate species. It is important always to record the colour 'morphs', because they appear to vary in distribution and relative abundance from place to place, for reasons so far unexplained. Until the situation is clarified it will be useful to retain the names *Aplysilla sulfurea* and *Aplysilla rosea*.

Family APLYSILLIDAE

Synonyms

Form Thin, soft, brightly coloured incrustations, up to 40mm in extent, and 5mm in thickness, with the surface uplifted into low conules 0.5mm high (up to 2-3mm) by internal, upright, generally branching, horny fibres spaced roughly 0.8 to 1.6mm (even to 5mm has been reported) apart.

Photographs

Colour Pale yellow to bright sulphur yellow (*A. sulfurea*); deep red (*A. rosea*).

Smell None reported.

Consistency Sponge soft and compressible.

Surface Smooth in between conules. In expanded sponges one sees a network of which the polygonal areas are membranous and pierced by groups of ostia.

Apertures One to several oscules, often mounted at the ends of oscular chimneys, 1-3mm wide.

Contraction Contractile tissue is present in the soft matrix and lines the pores, canals and oscular chimneys.

Skeleton No spicules are present. The sponge is supported by upright horny fibres rising from the basal plate of spongin. These fibres may branch at intervals, and the branches can likewise branch, but adjacent fibres do not coalesce to form a network (i.e. skeleton is dendritic). The branches and stems are round in cross-section and have rounded tips. The fibres have a distinct core, making up about 8/10 to 9/10ths of the total thickness, which is covered by thin layers of spongin. In longitudinal section both core and superficial layers can be seen to be built up like a stack of thimbles, one over the next lower down. The fibres are generally 0.06 to 0.1mm thick at their base (even 0.3mm is reported) and 0.02mm or more thick distally. They are flexible and elastic when isolated. They do not contain foreign matter, such as embedded sand grains or spicules.

Voucher BELUM : Mc587.

Habitat On under-surfaces of stones on the shore; on rock and stones below low water.

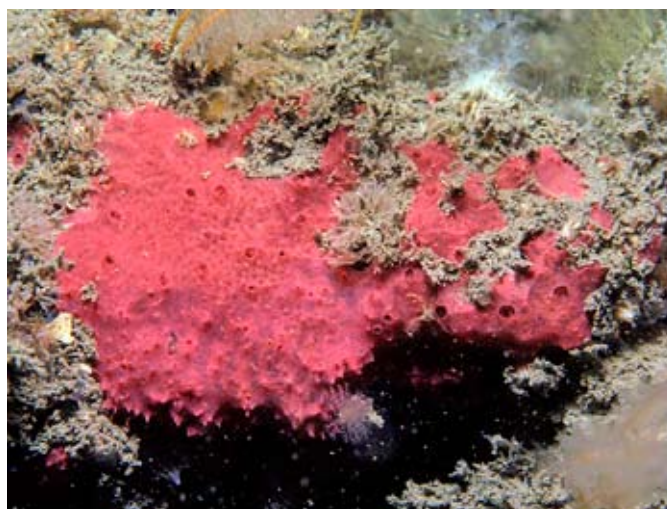

Distribution	Littoral to 640m depth (var. <i>rosea</i> ); to 320m depth (var. <i>sulfurea</i> ). Atlantic; North Sea; Channel; Mediterranean; etc.	
Identity	The colours, conulated surface, branching, non-anastomosing horny fibres and absence of spicules are diagnostic. Two closely related genera are <i>Chelonaplysilla</i> , with a conulate surface reinforced by a network of foreign matter visible to the eye; and <i>Pleraplysilla</i> , with an Aplysillid-like conulate surface but with the dendritic fibres covered by foreign matter. Both have been found at Roscoff and can be expected to be found in the British Isles.	
References	Arndt, 1935, p.110. Bergquist, 1980, p. 484. Vacelet, 1959, p.62.	
Sources	W. Clifford Jones, (S.M. Stone).	Editors D. Moss, B.E. Picton.

---

### ***Halisarca dujardini* Johnston, 1842:192.**

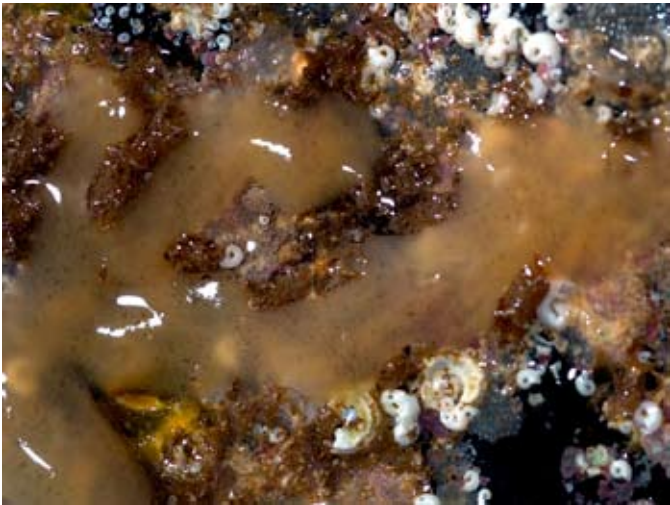
Family	HALISARCIDAE	
Synonyms	See Arndt, 1935, p.109. <b>Not</b> <i>Hymeniacidon dujardini</i> Bowerbank, 1866:224.	
Form	Slimy sheets up to 4cm x 5cm thick, or slimy cushions generally surmounted by a short, narrow oscular chimney.	
Photographs	Ruecallan, Rathlin Is., Antrim. (B.E. Picton)	
Colour	Ochraceous yellow, greyish, yellowish or creamy fawn.	
Smell	Not obvious.	
Consistency	Fairly firm and elastic.	
Surface	Slippery, smooth surface, composed of a distinct cuticle. Mottled with pale spots or pores when the sponge is expanded.	
Apertures	Oscules are sparsely distributed, frequently at the ends of short, cylindrical chimneys. Normally 1 - 2mm wide.	
Contraction	The oscular chimneys can close up, and the pores become indistinct.	
Skeleton	No spicules of any kind are present. Sections of the sponge sometimes reveal the presence of a network of fibrils in the soft matrix, helping to strengthen it. Sections cleared in clove oil reveal that the flagellated chambers are elongated (up to 35µm long and about 3µm in thickness) and sometimes branching; typically they radiate from exhalant canals which form the centre of 'aquiferous stars', but during the reproductive period (May to September usually) the aquiferous system tends to become disorganized to the extent that flagellated chambers remain only in the peripheral regions of the sponge.	
Spicules	None.	
Habitat	On small stones, in the empty shells of lamellibranchs, on the carapace of crabs (e.g. <i>Inachus</i> , <i>Macropodia</i> ), at the base of gorgonians, from 10 - 50m depth or more ("80m", Lévi, "300m", Arndt). At Low Water Spring Tide levels on the shore it occurs under overhangs, in fissures and on holdfasts of <i>Laminaria</i> . At mean tide levels it is found under stones and boulders. In rock pools it may occur on <i>Fucus serratus</i> and <i>Ascophyllum nodosum</i> , but possibly a different species is involved here (see below).	
Distribution	Atlantic coasts of Europe; Mediterranean; etc.	

Identity	Superficially these thin slimy sheets, greyish brown in colour, can be confused with <i>Hymedesmia brondstedii</i> , but the absence of spicules distinguishes <i>Halisarca</i> from <i>Halichondria brondstedii</i> . It can also be easily distinguished from the other 'slime sponge', <i>Oscarella lobularis</i> , by the presence of a superficial cuticle, the absence of small lobules on the surface and the presence of elongated, not spherical, flagellated chambers. It is much more difficult to separate <i>Halichondria dujardini</i> from <i>Halichondria metschnikovi</i> Lévi, 1956:87; these can only be distinguished by minute details of gametogenesis and larval development. Details are given in the following Table. <i>Halichondria metschnikovi</i> occurs on <i>Fucus serratus</i> and <i>Ascophyllum nodosum</i> at the mouths of estuaries (Lévi). The specimens on brown weed in the photograph occurred in a rock pool at Church Island in the Menai Straits. It was not possible to decide which species was represented.
Photographs	123, 124, 126.
References	Arndt, 1935, p.109. Bergquist, 1980, p.490. Lévi, 1956, pp.1-184.
Sources	W. Clifford Jones, (S.M. Stone).                      Editors D. Moss, B.E. Picton.

	<i>Halisarca dujardini</i>	<i>Halisarca metschnikovi</i>
<b>Spermatogenesis</b>	Occurs in grouped cysts before ovogenesis. Synchronous development of gametes in each cyst.	Short period of spermatogenesis occurring at time of maturation of ovocytes. Different stages of spermatogenesis occur in each cyst.
<b>Ovogonial stages</b>	More numerous. Development is synchronous and involves migration and aggregation.	Fewer, little movement involved, not gregarious.
<b>Mature ovocytes</b>	Spherical, up to 90-95µm in diameter. Several nucleoli.	Ellipsoidal, up to 130µm long. One nucleolus.

## BIBLIOGRAPHY

- ARNDT, W. (1935). Porifera (Systematischer Teil). IIIa. [In] Grimpe, G. & Wagler, E. [editors], *Die Tierwelt der Nord und Ostsee*, Leipzig, 140 pp., 1 figs. 1-239.
- BAMBER, R.N. & COUGHLAN, J. (1989) The marine fauna and flora of Druridge Bay. *Central Electricity Research Report RD/L/3470/R89*
- BERGQUIST, P.R. (1978) *Sponges*. London (Hutchinson). 268pp.
- BERGQUIST, P.R. (1980a) The ordinal and subclass classification of the Demospongiae (Porifera), appraisal of the present arrangement, and proposal of a new order. *New Zealand J. Zool.* **7(1)**: 1-6
- BERGQUIST, P.R. (1980b) A revision of the supraspecific classification of the orders Dictyoceratida, Dendroceratida and Verongida (Class Demospongia) *New Zealand J. Zool.* **7(4)**: 443 - 503
- BERGQUIST, P.R., HOFHEINZ, W., & OESTERHELT, G. (1980) Sterol composition and the classification of the Demospongiae. *Biochem. Syst. Ecol.* **8(4)**: 423 - 435
- BERGQUIST, P.R., LAWSON, M.P., LAVIS, A. & CAMBIE, R.C. (1984) Fatty acid composition and the classification of the Porifera. *Bioch. Syst. Ecol.*, **12(1)**: 63 - 84
- BERGQUIST, P.R. & WARNE, K.P. (1980) The Marine Fauna of New Zealand: Porifera, Demospongiae, Part 3. (Haplosclerida and Nepheliospongia). *Memoirs N.Z. Oceanogr. Inst No.* **87**: 1 - 77
- BOROJEVIC, R., CABIOCH, L., & LEVI, C. (1968) Inventaire de la faune marine de Roscoff. No. 2. Spongiaires. *Editions de la station biologique de Roscoff.* 44 pp.
- BOROJEVIC, R., FRY, W.G., JONES, W.C., LÉVI, C., RASMONT, R., SARA, M. & VACELET, J. (1968) A reassessment of the terminology for sponges. *Bull. Mus. natn. Hist. nat. Paris* (2 Ser.), **39**: 1224-1235.
- BOURY-ESNAULT, N. (1970) Un phénomène de bourgeonnement externe chez l'éponge *Axinella damicornis* (Esper). *Cah. Biol. mar.*, **11**: 491-496, 2 figs., 1pl.
- BOURY-ESNAULT, N. (1974) Structure et ultrastructure des papilles d'éponges du genre *Polymastia* Bwk. *Archs. Zool. exp. gén.*, **115 (1)**: 141-165, 17 figs., 5pls.
- BOURY-ESNAULT, N. (1987) The *Polymastia* species (Demosponges, Hadromerida) of the Atlantic area. In Vacelet, J. & Boury-Esnault N. (eds), *Taxonomy of Porifera from the N.E. Atlantic and Mediterranean Sea.* : 29-66. Berlin (Springer-Verlag), ISBN 3-540 16091-4.
- BOURY-ESNAULT, N. & LOPES, C. (1985) Les Demosponges littorales de l'archipel des Açores. *Ann. de l'Inst. Ocean. Monaco* **61(2)** : 149-225
- BOWERBANK, J.S. (1864) *A Monograph of the British Spongiadae*, Vol. I. London (Ray Society), xx & 290pp., 37pls.
- BOWERBANK, J.S. (1866) *A Monograph of the British Spongiadae*, Vol. II. London (Ray Society), xx & 388pp.
- BOWERBANK, J.S. (1874) *A Monograph of the British Spongiadae*, Vol. III. London (Ray Society), xvii & 367pp., 92pls.
- BOWERBANK, J.S. (1882) *A Monograph of the British Spongiadae*, Vol. IV. London (Ray Society), xvii & 250pp., 16pls.
- BUIZER, D.A.G. & VAN SOEST, R.W.M. (1977) *Mycale micracanthoxea* nov. spec. (Porifera, Poecilosclerida) from the Netherlands. *Netherlands Journal of Sea Research.*, **11** 297-304.
- BURTON, M. (1930) Additions to the sponge fauna at Plymouth: *J.Mar.biol. Ass. Plym.*, **16**: 489-507, 9 figs.
- BURTON, M. (1935) Notes on British sponges, with a description of a new genus and species. *Ann. Mag. nat. Hist.* **15**: 651-653.
- BURTON, M. (1963) *A Revision of the Classification of the Calcareous Sponges. With a catalogue of the specimens in the British Museum(Natural History)*. London (British Museum (NH)), 693pp., 375 figs.
- CABIOCH, L. (1968) Contribution à la connaissance de la faune des spongiaires de la Manche occidentale. Démosponges de la région de Roscoff. *Cah. Biol. mar.*, **9**: 211-246, 2pls.
- DENDY, A. & ROW, R.W.H. (1913) The classification and phylogeny of the calcareous sponges with a reference list of all the described species, systematically arranged. *Proc. zool. Soc. Lond.*, Sept. 1913, : 704-813.
- DESCATOIRE, A. (1969) Les peuplements sessiles de l'archipel de Glénan de l'infra littoral rocheux. II. Notes systématiques à propos de l'inventaire des spongiaires. *Vie Milieu*, **20**: 9-29.

- FORSTER, G.R. (1955) *Hemimycale columella* (Bowerbank) : A short description and history of the species. *J. Mar. Biol. Ass. UK* **34**: 553-557.
- FRY, W.G. (1971) The biology of larvae of *Ophlitaspongia seriata* from two N. Wales populations. *Fourth European Marine Biology Symposium*, ed. D.). Crisp(C.U.P.), 155-178.
- GRAAT-KLEETON, G. (1965) Les *Halichondria* de Roscoff. *Proc. K. ned. Acad. Wet., Amsterdam*, **68** (3c): 166-174.
- GRIESSINGER, J.M. (1971) Etudes des Renierides de Mediterranee (Demosponges, Haplosclerides) *Bull. mus. nat. Hist. nat.* **(3) 3** (*Zoologie 3*): 97 - 182
- HAECKEL, E. (1872) *Die Kalkschwamme, eine Monographie (Bds 2, & Atlas of 60 pls)* Berlin.
- HARTLEY, W.G. (1979) *Hartley's Microscopy*. Charlbury (The Senecio Press Ltd.), x & 220pp.
- HARTMAN, W.D. (1958a) Natural history of the marine sponges of southern New England.,220p. *Bull.Peabody Mus. nat. Hist.*, **12**: 1-155. 12pls.
- HARTMAN, W.D. (1958b) A re-examination of Bidder's classification of the Calcarea. *Sys. Zool.*, **7** : 97-110.
- HARTMAN, W.D. (1964a) *Chapter 1. Phylum Porifera. In Smith, R.J. (ed.), Keys to marine invertebrates of the Woods Hole region.* Woods Hole Marine Biological Laboratory, Systematics Ecology Program: **1-7**,pl.1.
- HARTMAN, W.D. (1964b) Taxonomy of Calcareous Sponges. *Science* **144**: 711-712.
- HISCOCK, K. (1979) Systematic surveys and monitoring in nearshore sublittoral areas using diving. In Nichols, D.(ed), *Monitoring the Marine Environment*: .55-74. Institute of Biology, London.
- HISCOCK, K. & MITCHELL, R. (1980) The description and classification of sublittoral epibenthic ecosystems. In Price, J.H., Irvine, D.E.G. and Farnham, W.F. (eds), *The Shore Environment, Volume 2: Ecosystems*: .323-370. London (Academic Press).
- HISCOCK, K., STONE, S.M.K., & GEORGE, J.D. 1983 [1984]. The Marine Fauna of Lundy. Porifera (Sponges): A Preliminary Study. *Rep. LundyFld. Soc.*, **34**: 16-35.
- HOOPER, J. N. A. & VAN SOEST, R. W. M. (eds.) *Systema Porifera. Guide to the classification of sponges.* (Kluwer Academic/Plenum Publishers: New York, Boston, Dordrecht, London, Moscow).
- HOWSON, C.M.; CHAMBERS, S.J. 1999. *Ophlitaspongia* and *Ophlitaspongia papilla* reinstated, and a new species of *Ophlitaspongia* described (Porifera: Demospongiae: Microcionidae). *Journal of the Marine Biological Association of the United Kingdom* **79**(4): 609-620.
- JONES, W. C. (1987) Skeletal variation in embryo-containing specimens of *Haliclona rosea* (Bowerbank) from Anglesea, North Wales. In Vacelet, J. & Boury-Esnault N. (eds), *Taxonomy of Porifera from the N.E. Atlantic and Mediterranean Sea*. : 101-124. Berlin (Springer-Verlag), ISBN 3-540 16091-4.
- JONES, W. C. (1987) [1990] Seasonal variations in the skeleton and spicule dimensions of *Haliclona elegans* (Bowerrbank) sensu Topsent (1887) from two sites in North Wales. In Jones, W. C. (ed) *European Contributions to the Taxonomy of Sponges*: 109-129. *Publications of the Sherkin Island Marine Station* No. 1, ISBN 1-870492-05-6.
- KONNECKER, G. (1973) Littoral and Benthic Investigations on the West Coast of Ireland. I. *Proc. Roy. Irish Acad.*, **73B**, 451-472.
- LÉVI, C. (1956) Étude des *Halisarca* de Roscoff. Embryologie et systématique des Démosponges. *Archs. Zool. exp. gén.*, **93**(1): 1-184.
- LÉVI, C. (1960) Les Démosponges des côtes de France. I. Les Clathriidae. *Cah. Biol. mar.*, **1**: 47-87.
- LILLY, S.J., SLOANE, F., BASSINDALE, R., EBLING, F.J., & KITCHING, J.A. (1953) The ecology of the Lough Ine rapids with special reference to water currents. IV. The sedentary fauna of sublittoral boulders. *J. anim. Ecol.* **22** : 87-122
- LUNDBECK, W. (1905) Porifera (part II) Desmacidonidae (pars.). *Danish Ingolf Expedition*, Vol VI: 219pp 20pls
- MINCHIN, E.A. 1904[1905]. The characters and synonymy of the British species of sponges of the genus *Leucosolenia*. *Proc. zool.Soc. Lond.*, **2**: 349-396.
- PANSINI, M. 1982 [1983]. Notes on some Mediterranean *Axinella* with description of two new species. *Bull. Mus.Ist. Biol. Univ. Genova*, **50-51**: 79-98.

- RIDLEY, S.O. & DENDY, A. (1887) Report on the Monaxonida collected by HMS Challenger during the years 1873-1876. *Report, Challenger; Zool.* Vol xx, part lix, pp i-lxviii, 1-275, 51pls, 1 map.
- ROWLANDS, P. (1983) *The Underwater Photographer's Handbook*. London (Macdonald & Co.), 240pp.
- RUTZLER, K., & STONE, S.M. (1986) Discovery and significance of Albany Hancock's microscope preparations of excavating sponges (Porifera: Hadromerida: Clionidae). *Proc. Biol. Soc. Wash.* **99(4)** : 658-675
- SARA, M. & SIRIBELLI, L. (1960) [1961] La fauna di Poriferi delle 'secche' del Golfe di Napoli. I. la 'secca' della Gaiola. *Annu. Ist. Zool. Univ. Napoli* **12**:1-93, 26 figs.
- SIMPSON, T.L. (1968) The structure and function of sponge cells: new criteria for the taxonomy of Poecilosclerid sponges (Demospongiae). *Bull. Peabody Mus. nat. Hist.*, **25**: 1-141, 16pls.
- SIRIBELLI, L. (1961) Differenze nell 'aspetto esterno e nello scheletro fra *Axinella verrucosa* e *Axinella damicornis* (Esper) o.s. (Demospongiae). *Annali Ist. zool. Univ. Napoli*, **12**: 1-24, 3pls.
- SOEST, R.W.M. VAN (1980) Marine sponges from Curacao and other Caribbean localities. Part II Haplosclerida, (Porifera, Demospongiae). *Stud. Fauna Curacao Caribb. Islands* **62**: 1 - 173
- SOEST, R.W.M. VAN, (1987) [1990] Biogeographic and taxonomic notes on some Eastern Atlantic sponges. In Jones, W. C. (ed) European Contributions to the Taxonomy of Sponges: 13-28. *Publications of the Sherkin Island Marine Station* No. 1, ISBN 1-870492-05-6.
- SOEST, R.W.M. VAN, GUITERMAN, J.D., & SAYER, M. (1981) Sponges from Roaringwater Bay and Lough Ine. *Journal Sherkin Isl.* **1(2)**: 35 - 49
- SOEST, R.W.M. VAN, & STONE, S.M. (1986) *Antho brattegardii* sp. n. (Porifera: Poecilosclerida) , with remarks on and a key to the Clathriids of Norwegian waters. *Sarsia* **71**: 41-48
- SOEST, R.W.M. VAN, & WEINBERG, S. (1980) A note on the sponges and octocorals from Sherkin Island and Lough Ine, Co. Cork. *Irish Nat. J.* **20(7)**: 1 - 15
- SOLLAS, W.J. (1888) Report on the Tetractinellida collected by HMS Challenger during the years 1873-1876. *Report Challenger; Zool.* vol xxv: i-clxvi, 1-458, 44 pls, 1 map.
- STEENSTRUP, E., & TENDAL, O.S. (1982) The genus *Thenea* (Porifera, Demospongia, Choristida) in the Norwegian Sea and adjacent waters: an annotated key. *Sarsia* **67(4)**: 259 - 268
- STEPHENS, J. (1912) Marine Porifera of the Clare Island Survey. *Proc. Roy. Irish. Acad.*, **31(59)**: 1 - 41
- STEPHENS, J. (1916) Preliminary notice of some Irish sponges - The Monaxellida (suborder Sigmatomonaxellida) obtained by the Fisheries Branch of the Department of Agriculture and Technical Instruction, Ireland. *Ann. Mag. nat. Hist.* **(8)20**: 232 - 242
- STEPHENS, J. (1917) Sponges collected by the dredging expeditions of the Royal Irish Academy and the Royal Dublin Society. *Proc. R. Ir. Acad.*, **34(1)**: 1 - 16
- STEPHENS, J. (1921) Sponges of the coast of Ireland. II. The Tetraxonida (concluded). *Dept. Agr. Ireland, Fisheries Sci. Invest.*, 1920, II: 1 - 75 Dublin
- STONE, A.R. (1970) Growth and reproduction of *Hymeniacion perleve* (Montagu) (Porifera) in Langstone Harbour, Hampshire. *J. Zool., Lond.*, **161**: 443-459.
- TOPSENT, E. (1890) Étude des spongiaires. I. Observations sur quelque espèces du genre *Raspailia*. Nardo. *Revue biol. N.Fr.*, No. **8**: 289-298.
- TOPSENT, E. (1891) Essai sur la faune des spongiaires de Roscoff. *Arch. Zool. exp. gen.* Ser 2, **IX**: 523-554.
- TOPSENT, E. (1892) Contribution a l'étude des spongiaires de l'Atlantique Nord. *Résultats des Campagnes scientifiques accomplies sur son Yacht par Albert Ier Prince de Monaco*, Fasc ii, 165 pp, 11pls.
- TOPSENT, E. (1894) Étude monographique des Spongiaires de France. 1. Tetractinellida. *Arch. Zool. exp. gén.*, **2**: 259-400, 6pls.
- TOPSENT, E. (1896) Étude monographique des Spongiaires de France. 2. Carnosa. *Archs. Zool. exp. gén.*, **3**: 493-590. 3pls.
- TOPSENT, E. (1897) Sur le genre *Halicnemia* Bowerbank. *Mém. Soc. Zool. Fr.*, **10**: 235-251.
- TOPSENT, E. (1899) Documents sur la faune des spongiaires des Côtes de Belgique. *Arch Biol.* **16**: 105-115.
- TOPSENT, E. (1900) Étude monographique des Spongiaires de France. 3. Monaxonida (Hadromerina). *Archs. Zool. exp. gén.*, **8**: 1-331. 8pls.

- TOPSENT, E. (1924) Revision des *Mycale* de l'Europe occidentale. *Ann. Inst. Océanogr. Paris, N.S.*, **1**: 77-118, 16 figs.
- TOPSENT, E. (1925) Étude de Spogiaires du Golfe de Naples. *Arch zool. Paris*, **63**: 623-725, pl viii.
- TOPSENT, E. (1928) Spongiaires de l'Atlantique et de la Méditerranée, provenant de croisières du Prince Albert Ier de Monaco. *Result. camp. sci. Alb. Monaco fasc 74*:1-376, 11 pls.
- TOPSENT, E. (1934) Éponges observées dans les parages de Monaco. *Pt.I.Bull. Inst. Océanogr. Monaco*, No. 650, 1-92.
- TOPSENT, E. (1936a) Étude sur des *Leucosolenia*. *Bull. Inst. Océanogr. Monaco*, No. **711**: 1-47
- TOPSENT, E. (1936b) Éponges observées dans les parages de Monaco. *Bull. Inst oceanogr. Monaco*, **686**: 1-70, 12 figs.
- TOPSENT, E. (1937) Sur les *Leucandra* des côtes de France. *Bull. Inst. Océanogr. Monaco*, No. **728**: 1-15.
- TUZET, O. (1973) Éponges calcaires In: P.P. Grasse, ed. *Traite de Zoologie, III. Spongiaires*. Masson, Paris, 716 pp.
- URIZ, M.J. (1983) Présence de l'espèce *Esperiopsis fucorum* en Méditerranée. *Vie Milieu*, **33** (3-4): 237-240.
- VACELET, J. (1959) Répartition générale des éponges et systématique des éponges cornées de la région de Marseille et de quelques stations Méditerranéennes. *Real. Trav. Stn. mar. Endoume*, No. **26**: 39-101, 3pls.
- VAN SOEST, R.W.M., & WEINBERG, S. 1980. A note on the sponges and octocorals from Sherkin Island and Lough Ine, Co. Cork. *Irish Nat. J.*, **20**, No. 1: 1-15.
- VETHAAK, A.D., CRONIE, R.J.A., & VAN SOEST, R.W.M. 1982. Ecology and distribution of two sympatric, closely related, sponge species, *Halichondria panicea* (Pallas, 1766) and *H. bowerbanki* Burton, 1930 (Porifera, Demospongiae), with remarks on their speciation. *Bijdr.Dierk.*, **52**: 82-102, 4pls.
- VOSMAER, G.C.J., (1928) *Bibliography of Sponges 1551-1913*. Cambridge (University Press), xii & 234pp.
- WEERDT, W.H. DE (1985) A systematic revision of the north-eastern Atlantic shallow-water Haplosclerida (Porifera, Demospongiae), Part I: Introduction, Oceanapiidae and Petrosiidae. *Beaufortia* **35(5)**: 61 - 91, pls I & II.
- WEERDT, W.H. DE (1986) A systematic revision of the north-eastern Atlantic shallow-water Haplosclerida (Porifera, Demospongiae), Part II: Chalinidae. *Beaufortia* **36(6)**: 81 - 165
- WEERDT, W.H. DE (1987) [1990] The marine shallow water Chalinidae (Haplosclerida, Porifera) of the British Isles. In Jones, W. C. (ed) *European Contributions to the Taxonomy of Sponges*: . 75-108. *Publications of the Sherkin Island Marine Station* No. 1, ISBN 1-870492-05-6.
- WHITE, G.W. (1978) Setting up the Microscope. *Microscopy*, **33**: 376-383.
- WIEDENMAYER, F. (1977) Shallow water sponges of the western Bahamas. *Experientia*, Suppl.28, 287pp.
- WILSON, H.V. (1925) Siliceous and horny sponges collected by the US Fisheries Steamer Albatross during the Phillipines Expedition, 1907-10. *Bull. U.S. natn. Mus., Bull.* **100 2(4)**: 273-532, pls.37-52.

# Index

## A

abundance 39  
 Acanthostyles 13  
 Acasta spongites 147  
 accession number 39  
 Acervochalina limbata 134, 146  
 Adocia fistulosa 142  
 Adreus fascicularis 66, 74  
 Aequipecten 89  
 Aequipecten opercularis 60, 97, 99, 112  
 alcohol 34  
 Alcyonium digitatum 90  
 Alcyonium epiphytum 62  
 Alcyonium glomeratum 119, 125  
 Alectona 70  
 Amphilectus fucorum 86, 94, 116, 119, 133  
 Amphilectus lobata 118  
 Anastomose 7  
 Anchinoe fictitius 105  
 Anchinoe paupertas 102  
 Ancorina ponderosus 54  
 Anisotropic reticulation 12  
 Antho inconstans 54, 83, 84  
 Antho involvens 53, 83, 84, 85  
 Antho involvens var. inconstans 84  
 Aphroceras ensata 48  
 Aplysilla sulfurea/rosea 149  
 APLYSILLIDAE 28  
 Ascending 11  
 Ascophyllum nodosum 150  
 associations 39  
 ASTROPHORIDA 27  
 Axinella arctica 125  
 Axinella damicornis 37, 71, 119, 122  
 Axinella dissimilis 66, 72, 107, 119, 120, 123, 124, 125, 148  
 Axinella erecta 125  
 Axinella flustra 80, 122  
 Axinella infundibuliformis 37, 56, 121, 123, 124, 125  
 Axinella polypoides 120, 121  
 Axinella pyramidata 120  
 Axinella verrucosa 120  
 AXINELLIDA 27  
 AXINELLIDAE 28

## B

bibliographies 36  
 Biemna peachii 115  
 Biemna variantia 115  
 BIEMNINAE 27  
 Boring 5  
 Branching-erect 6  
 Branching-repent 6  
 Branching processes 8  
 Brittle 7  
 Bubaris vermiculata 125

## C

Calcarea 17  
 Calthrops 13  
 Canada balsam 35  
 Canal patterns 9  
 Cavities 10  
 Centrotylote 13  
 CERACTINOMORPHA 27  
 Chalina arbuscula 142  
 Chalina inornata 134  
 Chalina oculata 142  
 Chalina pulcherrima 145  
 Chalinula ovulum 118  
 Chelae 16  
 Chelonaplysilla 150  
 Chlamys varia 97, 103, 111, 115  
 Choanocyte 10  
 Choanocyte chamber 10  
 choanocytes 17  
 Choanoderm 11  
 Choanosome 10  
 CHONDROSIIDAE 27  
 Choristid 12  
 Ciocalypa penicillus 67, 126  
 circalittoral 33, 38  
 CLADORHIZINAE 27  
 classification 17  
 Clathria barleei 82  
 Clathria foliata 82  
 Clathrina cerebrum 41  
 Clathrina clathrus 41  
 Clathrina contorta 41  
 Clathrina coriacea 41, 42, 53  
 Cliona celata 69  
 CLIONIDAE 27  
 clove oil 35  
 coastal type 38  
 COELOSPHAERINAE 27  
 Collagen 11  
 collection 33  
 colour 7  
 column 11  
 communities 38  
 Compact 7  
 competition 39  
 Compressible 7  
 Consistency 7  
 Conulate 8  
 Cortex 11  
 Corybas lobata 117, 118  
 Corybas ovulum 118  
 Corynactis viridis 90  
 Craniella zetlandica 56  
 Crella rosea 109, 132  
 CRELLINAE 27  
 Crumbly 8  
 crusts 33  
 Cuplike 6  
 Cushions 5



Cylindrical 6  
Cystoseira 107, 147

## D

Demospongiae 17  
Dendoryx dujardini 99  
Dendoryx incrustans 92  
DENDROCERATIDA 28  
Dendrodoa 41, 53  
depth zone 38  
Dercitus bucklandi 52  
Desmacella annexa 54  
Desmacella variantia 115  
Desmacidon fruticosum 91  
DESMACIDONINAE 27  
Desmacidon pannosus 134  
DESMOXIIDAE 28  
Diact 13  
Diazona violacea 125  
Dichotomous 7  
DICTYOCERATIDA 28  
Dictyoclathria beanii 83  
Dictyocylindrus fascicularis 74  
Dictyocylindrus hispidus 77  
Dictyocylindrus ramosus 78  
Dictyocylindrus stuposus 71  
diversity 33  
Donatia lyncurium 57  
Dysidea fragilis 134, 135, 147  
Dysidea pallescens 148

## E

Echinating 11  
Ecionemia coactura 53  
Ecionemia ponderosa 54  
Ectosome 10  
Ectyodoryx. 94  
Elastic 7  
Endectyon delaubenfelsi 79, 123  
Endectyon spp. 72  
Endectyon teissieri 80, 123  
Esperella murrayi 111  
Esperella sordida 114  
Esperia placoides 111  
ESPERIOPSINAE 27  
Esperiopsis fucorum 116  
Euasters 16  
Eumastia 127  
Eunicella verrucosa 119, 125  
Eurypon major 80, 81  
Even 8

## F

Feel 10  
Fibre 11  
Fibrillar collagen 11  
Firm 7  
Fistulate 8  
Flagellated chamber 10

Fleshy 8  
Flustra foliacea 123  
Fragile 7  
Friable 8  
Fucus 147  
Fucus serratus 150

## G

Gellius angulatus 136  
Gellius fibulatus 138  
Gellius ravus 139  
Grantia compressa 45, 46  
Grantia compressa. 47  
Granular 10  
grid reference 38  
Guancha lacunosa 42

## H

habitat 37  
HADROMERIDA 27  
Hairs 9  
Halichondria 28  
Halichondria (Topsentia) difficilis 130  
Halichondria agglomerans 130  
Halichondria bowerbanki 37, 127, 133  
Halichondria caruncula 131  
Halichondria cinerea 133  
Halichondria coalita 127  
Halichondria distorta 120  
Halichondria foliata 82  
Halichondria hibernica 99  
Halichondria membrana 129  
Halichondria metschnikovi 151  
Halichondria montagui 137  
Halichondria panicea 37, 117, 127, 129  
Halichondria reticulata 129  
Halichondria topsenti 129  
HALICHONDRIDA 27  
HALICHONDRIIDAE 28  
Halichondroid 12  
Haliclona 28, 53, 130  
Haliclona angulata 136, 140  
Haliclona cinerea 137  
Haliclona fibulata 136, 138  
Haliclona fistulosa 135, 141  
Haliclona indistincta 138  
Haliclona limbata 28, 146  
Haliclona oculata 66, 72, 121, 142, 143, 148  
Haliclona oculata. 66  
Haliclona rava 136, 139  
Haliclona rosea 137, 140  
Haliclona simulans 143  
Haliclona urceolus 145, 146  
Haliclona viscosa 133, 137, 144  
Halcnemia patera 75  
Halisarca dujardini 51, 99, 150, 151  
Halisarca lobularis 51  
Halisarca metschnikovi 151  
HALISARCIDAE 28

HAMACANTHINAE 27  
 HAPLOSCLERIDA 28  
 Hard 7  
 HEMIASTERELLIDAE 27  
 Hemimyscale columella 37, 102, 104, 105  
 Hexadella 51  
 High friction 10  
 Hirsute 9  
 Hispid 9  
 Homaxinella subdola 62, 65  
 HOMOSCLEROMORPHA 27  
 Homoscleromorpha 17  
 Hydrallmania falcata 118  
 Hymedesmia brondstedii 99, 151  
 Hymedesmia coriacea 99  
 Hymedesmia jecusculum 100, 105  
 Hymedesmia pansa 101  
 Hymedesmia paupertas 102, 104  
 Hymedesmia paupertas, 65  
 Hymedesmia radiata 99  
 Hymedesmia stephensi 103  
 Hymedesmia tenuicula 64  
 HYMEDESMIINAE 27  
 Hymedesmoid 12  
 HYMEDIACIDONIDAE 28  
 Hymeniacidon armatura 103  
 Hymeniacidon dujardini 150  
 Hymeniacidon kitchingi 133  
 Hymeniacidon perleve 68, 131  
 Hymeniacidon sanguinea 131  
 Hymeniacidon subclavata 114  
 Hymeniacidon sulphurea 63  
 Hymeraphia stellifera 80, 81  
 Hymeraphia vermiculata 125  
 Hymeraphia vermiculata var. erecta 125

**I**

identification 36  
 Inachus 150  
 inclination 39  
 Incompressible 7  
 Inelastic 7  
 infralittoral 38  
 Iophon hyndmani 96  
 Iophon ingalli 96  
 Iophon nigricans 98, 133  
 Iophonopsis nigricans 98  
 Iophon pattersoni 97  
 Irregular Folds 8  
 Isodictya (Halichondria) clarkei 118  
 Isodictya barleei 82  
 Isodictya beanii 83  
 Isodictya cinerea 137  
 Isodictya clava 145  
 Isodictya dissimilis 120  
 Isodictya edwardii 116  
 Isodictya elegans 137  
 Isodictya fimbriata 93  
 Isodictya fistulosa 141  
 Isodictya fucorum 116

Isodictya gracilis 116  
 Isodictya laciniosa 82  
 Isodictya lobata 118  
 Isodictyal reticulation 12  
 Isodictya lurida 93  
 Isodictya macandrewii 141  
 Isodictya normani 116  
 Isodictya peachii 137  
 Isodictya uniformis 116  
 Isotropic reticulation 11

**L**

L. botryoides 41, 43  
 L. complicata 44  
 L. contorta 43  
 L. variabilis 43  
 labels 35  
 Lamellate 6  
 Laminaria hyperborea 38, 130  
 larvae 17  
 latitude/longitude 38  
 LATRUNCULIIDAE 27  
 Laxosuberites spp. 61  
 Leathery 10  
 Leucandra gossei 48  
 Leucandra nivea 49  
 Leucogypsia. 49  
 Leuconia 50  
 Leuconia barbata 49, 50  
 Leuconia gossei 37, 48, 49, 50  
 Leuconia johnstoni 46, 49, 50  
 Leuconia nivea 49  
 Leucosolenia 43  
 Leucosoleniaánivea 50  
 Leucosolenia botryoides 43, 44  
 Leucosolenia complicata 37, 43  
 Leucosolenia coriacea 41  
 Leucosolenia lacunosa 42  
 Leucosolenia nivea 37  
 Leucosolenia variabilis 37, 44  
 light 39  
 literature 36  
 Lithophyllum 77  
 Lithothamnion. 51  
 Lophelia 82

**M**

Macropodia 150  
 Massive-fig 5  
 Massive-flanged 6  
 Massive-globose 5  
 Massive-lobose 5  
 Massive-pear 5  
 medial 7  
 Megasclere 13  
 Menyllus nigricans 98  
 Mesial 7  
 Mesohyl 11  
 methods 37

*Microciona ambigua* 108  
*Microciona armata* 88, 89  
*Microciona atrasanguinea* 86, 87, 89  
*Microciona atrasanguinea.* 90  
*Microciona dives* 107  
*Microciona fallax* 90, 91  
*Microciona fictitia* 105  
*Microciona plumosa* 106  
*Microciona spinarcus* 84, 90, 91  
*Microciona strepsitoxa* 89  
 MICROCIONIDAE 27  
 microhabitat 39  
 Microrhabds 13  
 Microscleres 13  
 microscleres 17  
 microscopy 36  
 Moderate friction 10  
*Modiolus modiolus* 96, 97, 115  
 Monact 13  
 Monaxon 13  
 monaxons 17  
*Mycale (Aegagropila) contarenii* 110  
*Mycale (Aegagropila) rotalis* 113  
*Mycale (Carmia) macilenta* 112  
*Mycale (Carmia) similaris* 114  
*Mycale (Mycale) lingua* 111  
*Mycale contarenii* 113, 115  
*Mycale macilenta* 111, 115  
*Mycale ovulum* 118  
*Mycale rotalis* 114, 115  
*Mycale similaris* 113  
 MYCALIDAE 27  
 MYCALINAE 27  
*Myxilla cf. rosacea* 95  
*Myxilla fimbriata* 93  
*Myxilla incrustans* 91, 92, 98, 129  
*Myxilla involvens* 83  
*Myxilla rosacea* 94, 98, 109  
 MYXILLIDAE 27  
 MYXILLINAE 27

## O

observations 33  
*Ophiothrix fragilis* 76  
*Ophlitaspongia papilla* 86  
*Ophlitaspongia seriata* 86, 88  
 orientation 39  
*Oscarella* 51  
*Oscarella cf. lobularis* 51  
*Oscarella lobularis* 51, 151  
 Oscular chimneys 8  
 Oscule 10  
 osculum 10  
 ostia 10  
 Ostium 10

## P

*Pachaxinella subdola* 65  
*Pachymatisma johnstonia* 55

*Pachymatisma johnstonia*, 131  
 Palisade 11  
 Papillate 8  
*Paratimea constellata* 73  
*Parazoanthus axinellae* 119  
 Pecten 90  
*Pentapora foliacea* 119  
*Phakellia robusta* 125  
*Phakellia rugosa* 125  
*Phakellia ventilabrum* 56, 123, 124, 126  
*Phakellia ventilabrum*; 37  
*Phakellia vermiculata* 125  
 Phorbas 102  
*Phorbas dives* 107  
*Phorbas fictitius* 37, 104, 105  
 PHORBASINAE 27  
*Phorbas plumosum* 106, 107  
 photographs 33, 39  
 photography 33  
 phylum Porifera 17  
 Pinacoderm 10  
*Pleraplysilla*, 150  
*Plocamia inconstans* 84  
*Plocamiancora arndti* 108  
*Plocamilla coriacea* 54, 83, 85  
*Plocamionida ambigua* 108  
*Plumaria elegans* 43  
*Plumohalichondria atrasanguinea* 87  
*Plumohalichondria fictitia* 105  
*Plumohalichondria plumosa* 106  
*Plumoreticulate* 12  
 Plumose fibre 11  
*Pocillon hyndmani* 96  
 POECILOSCLERIDA 28  
*Polydora* 76  
 Polygonal grooves 9  
 Polymastia 126  
*Polymastia boletiformis* 37, 62, 66  
*Polymastia mamillaris* 37, 58, 68, 127  
*Polymastia mammeata* 68  
*Polymastia penicillus* 68  
*Polymastia robusta* 66  
 POLYMASTIIDAE 27  
 Polytomous 7  
 Polytylote 13  
*Posidonia* 108, 148  
 preservation 34  
*Pronax plumosa* 106  
*Prosuberites epiphytum* 62  
*Pseudaxinyssa digitata* 127  
*Pseudosuberites* 61  
*Pseudosuberites sulphureus* 61, 63  
 Punctate 9  
*Pytheas rosea* 109

## Q

Quadriradiate 13  
*Quasillina brevis* 61

## R

Radiate structure 11  
 Raphyrus griffithsii 69  
 Raspaigella (Spongisorites) genitrix 130  
 Raspailia 121, 143  
 Raspailia hispida 66, 71, 73, 77, 78  
 Raspailia hispida; 37  
 Raspailia pumila 79  
 Raspailia radiosus 79  
 Raspailia ramosa 66, 77, 78  
 Raspailia rectangulus 79  
 Raspailia ventilabrum 80  
 Raspailia viminalis 79  
 Raspailia virgulosa 79  
 RASPAILIDAE 27  
 recording 34  
 Reniera fibulata 138  
 Renieroid 12  
 RHABDEREMIIDAE 27  
 Rhaphidostyla (Stylotella) 133  
 Rhaphidostyla incisa 135  
 Rhaphidostyla kitchingi 133  
 Rhaphiodesma sordida 114  
 Rooting tufts 7

## S

Sabellaria spinulosa 126  
 salinity 38  
 Scypha 50  
 Scypha ciliata 17, 45  
 Scypha compressa 46, 47  
 Scypha spp., 121  
 sections 35  
 Sertularia argentea 118  
 Sigmadocia 136  
 silica 17  
 silt 39  
 site features 38  
 site name 37  
 Skeleton 11  
 slide preparations 35  
 slime 7  
 Slimy 8  
 Slippery 10  
 smell 7  
 Smooth 8  
 Soft 7  
 Spanioplone armatum 103  
 species pairs 37  
 specimen 33  
 Spheraster 16  
 Spherulous cells 11  
 Spicule 11  
 spicule preparation 35  
 Spinose 9  
 Spinther oniscoides 117  
 SPIRASTRELLIDAE 27  
 SPIROPHORIDA 27  
 Spongia hispida 77  
 Spongin 11  
 spongin 17

Spongionella pulchella 148  
 Stelletta 53  
 Stelletta grubii 53, 55, 84, 85, 138  
 Stelletta grubii. 84  
 Stelletta lactea 54  
 Stelligera 121, 143  
 Stelligera rigida 70, 80, 120  
 Stelligera rigida; 37  
 Stelligera stuposa 37, 70, 71, 73, 77  
 Stipitate 7  
 Streptoscleres 16  
 Striated 9  
 Stryphnus ponderosus 53, 54, 84, 85  
 STYLOCORDYLIDAE 27  
 Stylopus 99  
 Stylopus dujardini 99  
 Stylostichon bihamigera 107  
 Stylostichon dives 107  
 Stylostichon plumosum 106  
 Stylotella columella 104  
 Stylotella inornata 134  
 Suberites (Hymeniacion) crustula 58  
 Suberites carnosus 37, 58, 59  
 Suberites domuncula 37, 60  
 Suberites elongatus 61  
 Suberites epiphytum 62  
 Suberites ficus 58, 59, 60  
 Suberites ficus. 59  
 Suberites gibbosiceps 61  
 Suberites lutea 60  
 Suberites massa 61  
 Suberites pagurorum 60  
 Suberites rubra 60  
 Suberites sulphurea 63  
 SUBERITIDAE 27  
 sublittoral fringe 33, 38  
 substrate 38  
 substratum 35, 39  
 Sulcate 9  
 Sycandra utriculus 47  
 Sycon ciliata 45

## T

techniques 33  
 TEDANIINAE 27  
 Terpios gelatinosa 64  
 Tethea collingsii 53  
 Tethea schmidtii 53  
 Tethea spinosa 135  
 Tethya aurantium 57  
 Tethya citrina 57  
 Tethya zetlandica 56  
 TETHYIDAE 27  
 Tethyopsilla zetlandica 56  
 Tethyspira spinosa 35, 135  
 Tetilla cranium 56, 58  
 Tetilla zetlandica 56, 58  
 Tetract 13  
 tetraxons 17  
 Thin sheets 5

Thoosa 70  
Thymosia guernei 76  
tidal streams 33  
tidal stream strength 38  
TIMEIDAE 27  
Tough 7  
Toxadocia 136  
Tract 11  
Tragiosa flustra 122  
Tragosa infundibuliformis 123  
Tragosa polypoides 120  
Triact 13  
Triaene 13  
triaxons 17  
Triradiate 13  
Tuberculate 8  
Tubularia 117  
Tylote 13

## U

Ulosa digitata 134, 147, 148  
underwater conditions 38  
Uneven 8

## V

Velutinous 9  
Verongia rosea 149  
VERONGIDA 28  
Vibulinus rigidus 70  
Vibulinus stuposus 71  
Villose 9  
Vioa celata 69

## W

wave exposure 38  
Wrinkled 8

## Y

Yvesia rosea 109

## Z

zones 33