



---

The Plankton of Lough Neagh: A Study of the Seasonal Changes in the Plankton by  
Quantitative Methods

Author(s): W. J. Dakin and Margaret Lata arche

Source: *Proceedings of the Royal Irish Academy. Section B: Biological, Geological, and  
Chemical Science*, 1912/1913, Vol. 30 (1912/1913), pp. 20-96

Published by: Royal Irish Academy

Stable URL: <https://www.jstor.org/stable/20516975>

---

JSTOR is a not-for-profit service that helps scholars, researchers, and students discover, use, and build upon a wide range of content in a trusted digital archive. We use information technology and tools to increase productivity and facilitate new forms of scholarship. For more information about JSTOR, please contact [support@jstor.org](mailto:support@jstor.org).

Your use of the JSTOR archive indicates your acceptance of the Terms & Conditions of Use, available at <https://about.jstor.org/terms>



JSTOR

Royal Irish Academy is collaborating with JSTOR to digitize, preserve and extend access to  
*Proceedings of the Royal Irish Academy. Section B: Biological, Geological, and Chemical Science*

III.

THE PLANKTON OF LOUGH NEAGH: A STUDY OF THE SEASONAL  
CHANGES IN THE PLANKTON BY QUANTITATIVE METHODS

By W. J. DAKIN, D. Sc., F.L.S.,

Senior Assistant in the Department of Zoology and Comparative Anatomy  
University College, London ;

AND

MARGARET LATARCHE, M. Sc., Zoology Department, Liverpool University.

PLATES IV-VI.

(BEING THE ELEVENTH REPORT FROM THE FAUNA AND FLORA COMMITTEE.)

Read NOVEMBER 11, 1912. Published JANUARY 27, 1913.

PREFACE.

TWENTY-TWO years ago Hensen, the veteran physiologist of Kiel, founded the Kiel School of Quantitative Plankton Research. Whatever may have been said in criticism of Hensen's work, there is no doubt that he provided a new stimulus which set plankton investigations on a different basis and aroused fresh enthusiasm in this line of research.

Whether the investigations have been carried out quantitatively or qualitatively, they have, since the detailed work of Hensen and his colleagues, been placed on a systematic foundation. Attempts have been made to determine the periodicity of the plankton, that is to say, the changes taking place throughout the year. In the succession of years it has been found that these changes take place in a regular and, on the whole, similar manner. Yet different years are perhaps marked by small variations in the time at which the different organisms attain their maximum development. Again, different lakes (varying in latitude, altitude, or environment) present interesting deviations, some large and some small, which have led to the study of the correlation of changes in the plankton with environment and meteorological phenomena.

The interest in the fresh-water plankton has advanced perhaps more rapidly than the interest in the marine plankton. This is probably due to the ease with which problems could be investigated in fresh-water owing to the foundation of biological stations. This applies particularly to the Continent,

where biological research is being pursued with so much energy at present. If it had not been for Sir John Murray and the Messrs. West, the British Islands would have been left hopelessly behind in investigations of this kind.

It is quite impossible for us to treat the historical side of fresh-water plankton research, for it has expanded to an enormous extent during the last twenty years. From the pioneer work represented by that fine monograph, "Le Léman" of Forel, it has extended until numerous specialists have taken up and treated not the plankton in general, but finally perhaps one particular genus alone.

It is only fitting that mention should be made here of the death of Forel, which occurred as this paper was nearing completion. He passed away on August 7 at the age of seventy-one years. Professor F. A. Forel was born at Morges on the shores of Lake Geneva, the lake to which he devoted his life in study. From 1868 onwards numerous papers have been given to the world dealing with the hydrobiology and hydrography of its waters. His great monograph on "Le Léman" which appeared between 1892 and 1904, is a foundation of scientific limnological research, and is remarkable for the wide range of knowledge, extending over very many sciences, possessed and turned to good account by the author.

It is perhaps in connexion with the theories of Seiches that Forel will be best remembered. Unfortunately we have not been able to treat at all the interesting subject of oscillatory movements in the waters of Lough Neagh. Little attention has, however, been paid to this subject; and Forel's contributions are known almost only to the specialists, and in this country to those keen workers on the Scottish lochs. There, Wedderburn and Murray have extended the theories of Forel to temperature oscillations.

Forel's life was devoted to science; and he leaves behind a lasting record of knowledge wrung from nature's hidden book.

The lakes of the Arctic Regions have been investigated by Ekman, Wesenberg Lund, Scourfield, Penard, and others. The North Temperate lakes have been treated in enormous detail, particularly the Baltic Lakes, for which there is a prodigious amount of literature. Amongst workers there may be mentioned Bachmann, Wesenberg Lund, West, Murray, Ostenfeld, Huitfeldtkaas, Ekman, Lemmerman, Lilljeborg, Zacharias, Apstein, and Seligo.

The Alpine Lakes have been investigated in very considerable detail. In America, we may note the work of Birge on Lake Mendota, Reighard on St. Clair, and Kofoid on the Illinois River. The lakes in Asia and the Tropics have also been investigated. The seasonal zooplankton of Irish lakes and

[D 2]

rivers is, however, but little known. The phytoplankton of Lough Neagh has been examined by the Messrs. West; but the catches were made only during a very short season of the year. As a matter of fact, we now know that a visit to a lake like Lough Neagh would only permit us to describe the planktonic flora or fauna at the particular time of the visit. The change of the seasons is just as clearly marked by the changes in the plankton, that is the appearance and disappearance of characteristic organisms, as by the opening of the buds in spring or the fall of leaf in autumn. Up to the present time extremely little has been known of the periodicity of the British fresh-water plankton.

The relation of the lakes of Scotland to those of Europe was referred to in the course of Sir John Murray's investigation of the Scottish lochs. This year a paper appeared by the Messrs. West, which may be said to be the first detailed paper on the subject of periodicity. It deals with the phytoplankton alone, however, and that only of certain lakes in Scotland and the English Lake District. It is furthermore only a qualitative research. The present paper is the first quantitative research on the plankton (phyto and zoo-plankton) of the British lakes.

The research was commenced by one of us whilst on the staff of the University of Belfast, and was enabled by the aid of grants from the Royal Society and the Royal Irish Academy. To both these bodies our thanks are due. Expeditions were made to the lake at first twice in three weeks; but as time went on and one of the authors' came to Liverpool, the length of the periods had to be increased. With the exception of two visits to the lake, all the catches were made by one of the authors, and thus we were assured of the uniformity of procedure, &c.

A discussion concerning the use of quantitative methods is given in the text. It may be said here, however, that whilst we consider certain features of the Kiel methods of absolute importance, we do not consider the detailed practice of the Kiel School to be the only practicable way of carrying out plankton research, nor is it always possible. Furthermore, we do not consider the Messrs. West justified in asserting that "the more detailed work concerning the phytoplankton, which, so far as we can see, in the British Lake areas will be quite of subordinate value, can be done piecemeal at any time by sufficiently qualified persons who possess the necessary means and time."<sup>2</sup> At the very most the above might apply to lakes they had investigated.

We are very much indebted to Professor Gwynne Vaughan, of Belfast University, for his great kindness, which alone enabled visits from Liverpool to Lough Neagh being made once every three weeks for a period. We wish

<sup>1</sup> Dakin.

<sup>2</sup> W. West and Professor G. S. West: "Periodicity of the Phytoplankton of some British Lakes," *Journ. Linn. Soc. Bot.* xl. 1912.



to thank Professor Lemmerman of Bremen and Mr. Scourfield for help in confirmation of systematic work, and Mr. Whitehouse of Belfast for help on various occasions.<sup>1</sup>

LOUGH NEAGH.

Lough Neagh, the largest lake in the British Isles, is a rectangular-shaped expanse of water, with a superficial area of 153 square miles. It is situated due west of Belfast, and about 13 miles distant from that town. It has its greatest area in Antrim; but Tyrone, Armagh, and Londonderry also contain some more or less considerable part of the lake. It lies in a depression, but a shallow depression only, and over the greatest part of its area the depth averages only 40 feet. The depth, as a matter of fact, is remarkably uniform. The maximum depth of 102 feet is attained in a narrow depression, which is a kind of continuation of the River Bann. The length of the lake is 17 miles, the breadth 10 miles. Thus, looking across from shore to shore, the opposite banks appear far distant, and often, on misty days, are out of sight. This is so accentuated by the lowness of the banks that a view is often obtained which is probably seen nowhere else in the British Isles. Thus one stands looking out across a fresh-water lake which appears to extend far beyond the horizon. This idea of great size is often increased by the great waves, due to the possibility of the wind blowing unhindered down and across miles of water. Lough Neagh is certainly a characteristic lake. Its low-lying shores, however, have robbed it of the beauty of the Scottish or English lakes. Its storms do not encourage the tourist to visit its waters. There are very few islands, and these are small. The following figures will give a relative idea of its size, compared with that of some famous lakes:—

Lough Neagh,	. area,	153 square miles.	
Lake Superior,	. „	31,200 „	„
Loch Lomond,	. „	27 „	„
Lake Geneva,	. „	225 „	„
Lough Neagh,	. depth average,	40 feet.	Maximum, 102 feet.
Lake Superior,	. . . . .	„	1,008 „
Loch Lomond,	. . . . .	„	623 „
Lake Geneva,	. . . . .	„	1,015 „
Loch Ness (Scotland),	. . . . .	„	754 „
Lough Neagh,	. volume of water,	161,000 million cubic feet.	
Lake Superior,	. „ „ „	413,000,000	„ „ „
Loch Lomond,	. „ „ „	93,000	„ „ „
Lake Geneva,	. „ „ „	3,175,000	„ „ „
Loch Ness,	. „ „ „	263,000	„ „ „

<sup>1</sup> Professor Karl Pearson very kindly made suggestions concerning certain biometrical calculations.

*Geology.*—The lake lies in a volcanic area on basalt of Miocene age; and this basalt rises from the lake on three sides until it reaches altitudes of about 1,500 feet. On the south of the lake, and forming a very low marshy ground here, is a thick deposit of clays and sands, with lignite and clay ironstone. The banks are formed of drift, etc., which covers the basalt and also the clay above mentioned. This great southern clay deposit is of considerable thickness, lying, according to the British Association Report of 1874, under 50 feet of drift, and consisting of more than 260 feet of stratified grey and blue clays and sand. This may be taken as the former delta of either the Upper Bann or the river Blackwater. The opinion of Edward Hardman, of the Geological Survey, is that the lake was formed at the close of the Miocene period before glacial times, and that after the basaltic flow had ceased, subsidences took place over a large area, producing a depression. In all probability the area of the lake was formerly very considerably greater than it is now.

The drainage channels into the lake and the outflowing rivers must have varied during Glacial times; but the question of this must be left to the geologist. We should like to emphasize at this point the necessity for the geologists to say whether Lough Neagh has ever been an arm of the sea or been occupied by salt water. As will be seen later on, there are features, such as the presence of *Mysis relicta* in the waters of the lake, which have given rise to the theory that Lough Neagh was once an arm of the sea, and that it was occupied by salt water. This question will be discussed later; but the presence of *Mysis relicta* supplies no evidence for the history of the lake. This must be left to the geologist.

At the present time the water of Lough Neagh is derived chiefly from the inflowing rivers, the Upper Bann, Blackwater, Ballinderry, Moyola, and Main Water. There are in addition several smaller rivers, one of which, the Six-mile Water, enters the lake at Antrim. It was from the mouth of this river that the collecting expeditions set out. It will be rather important to know from what ground this drainage-water comes. The Upper Bann flows over Silurian rocks and Miocene basalt. Near the lake it flows over clay and alluvium. In all the details which follow it must be remembered that the formations given are covered to a certain extent with boulder clay, alluvium, or bog; and the amount of actual rock-cutting that is carried out by the rivers is therefore not indicated. As a general rule, in the upper courses of the rivers the rocks are exposed. The Blackwater flows over Carboniferous limestone and Triassic rocks, the latter predominating, and further over bog and alluvium. The Ballinderry flows over Triassic rocks and Miocene basalt; the river Moyola chiefly over Miocene basalt; the Main Water flows over basalt, and the same applies to the Six-mile Water.

Thus it will be seen that Lough Neagh water is not derived from areas corresponding to older Palaeozoic outcrops. The following table, taken from the Reports on the Bathymetrical Survey of the Scottish lochs, shows the composition of the water of Lough Neagh and three other lakes for purposes of comparison:—

ANALYSIS OF LAKE WATER.

Dissolved Matter in parts per thousand.	Lough Neagh, 0·155.	Lake Geneva, 0·169.	Lake Champlain, 0·067.	Lake Baikal, 0·069.
Percentage Composition of Dissolved Matter.				
Ca . . .	17·7	27·8	21·2	23·4
Mg . . .	1·3	4·0	4·2	3·5
Na . . .	15·4	1·2	8·8	5·8
K . . .	—	0·9	—	3·4
CO <sub>3</sub> . . .	36·9	37·3	45·8	49·8
Cl . . .	5·7	0·6	1·8	2·4
SO <sub>4</sub> . . .	10·7	25·7	11·0	6·9
SiO <sub>2</sub> . . .	3·3	2·5	5·6	2·0
(AlFe) <sub>2</sub> O <sub>3</sub> . . .	6·7	trace	1·6	1·4

It will be noticed that the Lough Neagh water contains an exceptional amount of sodium, chlorine, and iron. The presence of sodium chloride is probably due to wind-blown salt from the sea. We have already seen that the lake is situated not far from the sea; and its surface exposed to the air is probably greater in proportion to the total volume of water than in most lakes of its size in the world.

The range of temperature of the water of Lough Neagh throughout the year is very great. This is what one would expect in a lake of such great area and slight depth. There is a great contrast here with the Scottish lakes, whose annual temperature-variation is only about 5–15° C. The summer temperature of these Scottish mountain-lakes is not high; and in many cases the water does not freeze during the winter. Lough Neagh has been frozen on several occasions in recent years, and to an extent to permit of skating. During that part of the winter falling in the period of our observations, the temperature of the air was rather mild in north-east Ireland, and the water of the lake did not freeze. During the summer a temperature of 20° C. is recorded; and this must have been far exceeded during the summer of 1911. The temperatures of the surface water are as follow:—

## A.

## TEMPERATURE OF SURFACE WATER.

1910—Feby. 23 ;	March 5, 4·4° ;	March 17, 5·5° ;	March 30, 7·2° ;
April 13, 7·7° ;	April 27, 8·6° ;	May 11, 9·5° ;	May 25, 14·3° ;
June 10, 15·0° ;	July 13, 20·0° ;	July 27, 16·5° ;	Aug., 17·3° ;
Sept. 8, 17·5° ;	Sept. 29, 14·5° ;	Oct. 21, 12° ;	Nov. 11, 7·5° ;
Dec. 1, 5·0° ;	Jan. 12, 4·6° .	1911—Feby. 3, 5·0° .	

Probably the summer temperature always exceeds 18° C. The high summer temperature is probably caused in the same way as that of the Danish lakes, by the broad littoral zone, where the water is heated up, and then distributed by currents.

The colour of the water of lakes is affected by four factors. First, we have the natural colour of pure water, due to selective absorption of the colours towards the red end of the spectrum and the reflection of blue rays. Secondly, there is the reflection of other rays of the spectrum by the bottom in shallow waters, and by mineral particles in suspension. Thirdly, it is affected by the plankton; and fourthly, by matter in solution. The colour is, to a large extent, therefore bound up with transparency. We were not able to make any determinations of the transparency of Lough Neagh, with either white screens or photographic methods. The water is, however, but slightly transparent; and the white plankton net disappeared at a depth of a few feet. The colour of the water is most marked. This is due to the large quantity of plankton present; and in this respect Lough Neagh presents the same contrast to the Scottish lakes as do those of Denmark.

The colour of the Scottish lakes appears to vary but little with the seasons, and never to show the turbid yellowish-green colour characteristic of the Danish lakes between May and November. Furthermore, they are but rarely covered with the "water-bloom" produced by the blue-green algae.

Lough Neagh, like the Danish lakes, is characterized by the yellowish-green colour due to the plankton. In the spring of 1910, the colour of the water was a dark olive green in March, but very much more blue in April; and the plankton catches in April were deep blue in colour. In May the colour of the plankton attained the yellowish-green hue, and became almost *yellow* in July.

Water-bloom was observed in Lough Neagh on March 30th, 1910, on an extremely calm day after several days' brilliant sunshine. This is, however, an early appearance. The greatest formation of water-bloom occurred in September. It was observed by one of us then on September 8th, but had been present for three days before this visit. On this occasion the surface of

the water was a bright green, with an alga (*Gomphosphaeria*), and the very slight breeze blowing was drifting this in long streaks towards the banks near Antrim. At the shore of the lake the water seemed to have been covered with a layer of green paint, so thick and so intense was the heaped-up "water-bloom." (See Microphoto.) This phenomenon, known as the "breaking of the meres" in England, is often seen in small and shallow lakes.

Features of Lough Neagh common to the Danish lakes are, then, the shallowness, the gently sloping shores, rectangular outline, high temperature of water in summer, small transparency, and yellow-green colour of the water, due to the plankton. On the other hand, Lough Neagh is much larger in area, and probably the chemical constitution of the water is different. The Scottish lakes, of great depth, and long, narrow shape, with steep shores and clear water, form a well-marked contrast.

The photographs (Plates IV and V) give some idea of the characteristic scenery of Lough Neagh, and they are especially intended as illustrations of the type of bank.

Photographs 1 and 3 are views taken looking over the lake from Toome. They show rather well the low-lying distant banks, and the large expanse of water, which seems to extend right on to the horizon. It is only on a very few days that, looking out from Antrim, one can see the opposite banks as a dim line in the distance.

Shane's Castle (Plate IV, fig. 2), as will be seen by reference to the map is situated to the north of Antrim. It was always passed on our way out to the plankton station. A flat sandy beach, with ripple-marks, extends here for some distance on certain occasions after the limit of vegetation is passed. It looks very like a sea-shore, in fact. This flat expanse is part of the shallow submerged bank. It is possible to wade out from the banks at Antrim for some distance, and a depth of 6 or 7 feet is common quite a little way out from the shore.

This beach at Shane's Castle is covered or free according to the direction of the wind and the amount of water in the lake.

Figs. 4 and 7 are pictures of the pollen-nets drying and of the hauling in of a net.

In this latter the pollen-nets are being used close inshore, in water only 8-10 feet deep, and the net has been set out in a circle just as a seine-net is used. The boat is the one used for our plankton observations. The Lough Neagh fishing-boats are characteristic craft, built on the lake, and capable of withstanding the terrific pounding caused by the short waves.

Fig. 5 is a photograph of the entrance of the Six-mile Water at Antrim.

It is the river whose mouth is used as a harbour for the pollen-fishing boats, and from here the plankton fishery was always carried on.

The low banks with grasses and dense wood should be noticed.

The remaining picture is very characteristic of the Lough Neagh shores near Antrim. The shores shelve gradually to the water, and are thickly wooded. The trees extend almost to the water's edge, and then a margin of grasses, often very prominent as in the photograph, completes the scene.

The banks are sandy, and many rare plants—rare for such an inland situation on the banks of a lake—are to be found.

#### METHODS EMPLOYED.

The method adopted in the course of this work has been to make a series of catches, all of which have been vertical hauls, with a well-known standard plankton net, at one station on Lough Neagh. The catches have been taken at close intervals throughout a year, even though this necessitated travelling from Liverpool each time the investigations were made. The total number of expeditions made to the lake was twenty-one. On each occasion a sailing-boat was chartered from Antrim; and a line was followed until a point about  $1\frac{1}{2}$  miles S.W. of the entrance of the Six-mile Water was reached. A series of marks were taken on the first expedition, so that the same position could be reached each time. The depth of the water was 40 feet on the first visit to the lake in 1910, but this was reduced to 38 feet after several weeks of dry weather. The weather conditions were always observed, and the catches were made as nearly as possible at the same time of day. Midnight catches have also been taken for completeness. A sounding was always taken before any net-work was carried out, and the boat was then anchored. It was necessary to anchor the boat in order that no drifting should take place whilst the net was being lowered.

In order to obtain absolutely complete knowledge of the plankton of Lough Neagh, it would be necessary to adopt the centrifuge. Such an intensive study would have been far beyond the powers of the two workers, and would have required the co-operation of many specialists. There is no doubt, however, that many species common in the water of Lough Neagh have never been captured.

From work carried out in April, 1912, at Port Erin, in the course of which sea-water was filtered first through net and then through a Chamberland filter, it was seen that the very minute phytoplankton formed no small part of the total plankton present in the water. These forms belonging to the Nannoplankton<sup>1</sup> must occur in Lough Neagh in great numbers, and probably very many unrecorded species exist there.

---

<sup>1</sup> Lohmann, Nannoplankton, 1911.

The Nansen net has been used in preference to the Hensen nets, chiefly because of convenience in handling. The whole aim of the work has been to *compare* a series of catches made throughout a year. To this end the most important point to keep in view was the taking of catches in a uniform manner with the same net.

In several cases we notice that *horizontal* hauls of a net have been used for a study of the periodicity of plankton (no mention whatever is made of methods in the Report of W. West & Professor G. S. West). This is a very unsafe method, accentuated when used by non-scientific workers. On several occasions on calm days we found at Lough Neagh that the plankton was concentrated in the upper few inches of water. On another day, perhaps within twenty-four hours, the same plankton was scattered anywhere between the bottom and surface by rough weather. Imagine the great difference between two horizontal hauls taken at these times. A vertical haul would have given true pictures of the plankton present.

Again, even on the calmest days it is impossible to tow a net so that it remains in the same layer of water. It would be quite possible on a calm day for two boats making horizontal hauls close to each other to have entirely different catches both in quantity and relative composition. This *could not* occur if vertical hauls were made. Hence, for the study of variation in plankton (periodic), vertical hauls must be made.

#### *The Nansen Net.*

The Nansen net is a closing net of bolting silk made by Andersen, of Christiana, Norway. It has been used largely by Herdman in the Irish Sea; and one of the authors, who made the catches at Lough Neagh, has had considerable experience with it in marine work. Four definite sizes are manufactured—diam. 35, 50, 75, and 100 cm.; and we have therefore a uniform set of nets here if workers buy from the maker. The net is conical in shape, with a mouth having a diameter of 35 cm. The length from mouth-opening to end of bag is 228 cm., but this is not all composed of filtering-tissue.

From the net-ring (which supports the mouth), extending down for about 58 cm., is a cylinder of non-filtering sailcloth. To this mouthpiece the actual net is attached. It is 170 cm. in length. The silk used (No. 20) runs seventy-two meshes to the centimetre; at the end of the silk bag there is a brass filtering bucket (fig. 2, *B*), which is attached by a bayonet-joint to a brass ring fixed to the silk, and also connected with the net-ring by three ropes. To these ropes, which are continued below the bucket, a heavy weight

[E 2]



is attached. The method of suspension of bucket and weight is such that neither is supported by the delicate silk.

The net-ring is connected by three head-ropes to a small ring (fig. 3, *t*). In addition to this a rope passes round the non-filtering part of the net through brass rings and forms a noose, the function of which is to throttle the net when the rope (fig. 3, *th*) is pulled.

The closing mechanism release is of brass. For use it is connected to the line from the boat. This line (fig. 3, line) is attached to it by the screw *a* (fig. 3). To the other end of the release mechanism are attached both the small ring (fig. 3, *t*) and the end of the throttling noose (fig. 3, *th*). The latter is, however, permanently attached, and, in fact, is the only rope securing permanently the net to the closing mechanism, and consequently to the lowering rope. The small ring which supports the net mouth is hooked on to the closing mechanism by the movable jaw *j* (figs. 3 and 4), which swings on the pivot *p*. This movable jaw is held closed by a spring-catch at *w*. When the ring *t* is hooked on to the releasing mechanism by the jaw *j*, the net is suspended in such a way that the mouth is horizontal and open. In this position the net is always lowered. The method of using the net is as follows:—The hauling rope is first attached to the releasing mechanism by the screw *a*. The net mouth is supported by the small ring which is hooked on to the releasing mechanism by the jaw *j*. In order to do this the bolt *b* is pressed down, and then allowed to catch the upper end of the jaw, which it secures, and keeps in position.

The throttling line is tied securely to the lower end of the releasing mechanism.

If the net is now held by the hauling rope, it hangs open with the mouth horizontal. To close the net a weight (known usually as a messenger) is allowed to run down the hauling rope. This

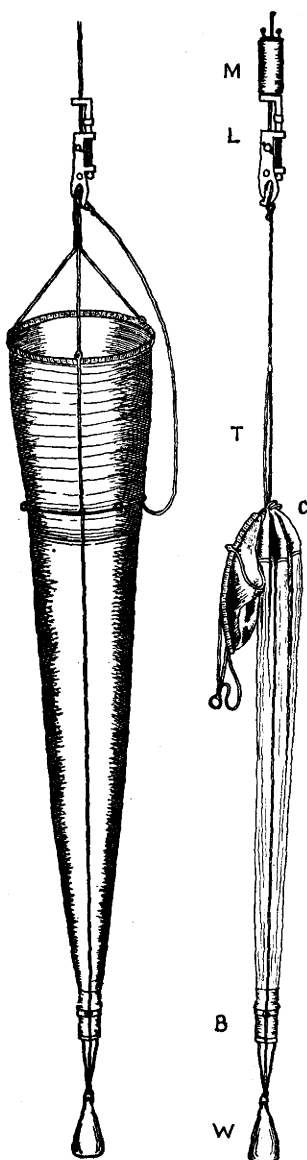

FIG. 1—Nansen Net open, as it descends and as it fishes.

FIG. 2—Nansen Net closed, as it is hauled in after fishing.

*M*, messenger to effect closing; *L*, releasing apparatus; *T*, throttling noose; *C*, sailcloth part of net; *B*, brass bucket containing the catch; *W*, weight.



strikes with force the bolt *b*, and as a consequence the bolt is depressed. This sets free the jaw *j*, which revolves, and allows the ring supporting the net-mouth to fall out (fig. 3). As a result the net falls away until the throttling rope becomes taut, tightens round the net, strangling it, and supports it in such a position that if the net is now pulled through the water it can neither catch nor lose anything (fig. 2).

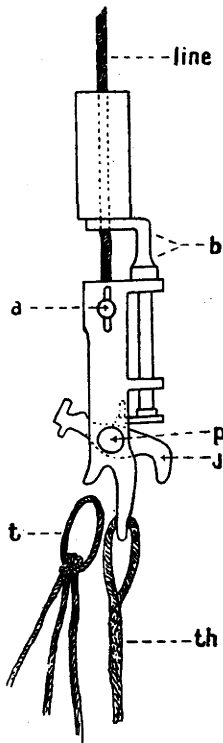

FIG. 3.—Closing Mechanism of Net with Messenger.

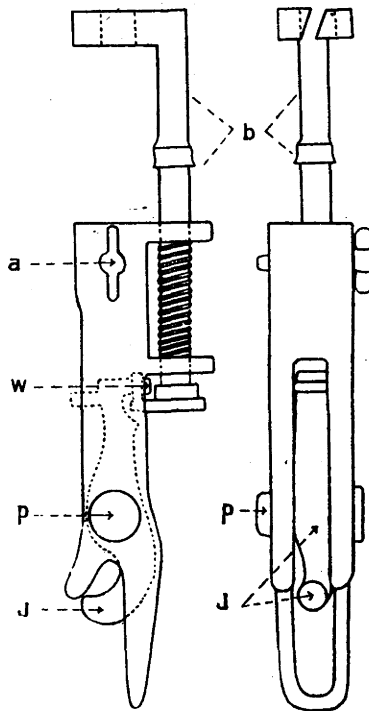

FIG. 4.—Closing Mechanism of Nansen Net.

The depth of water at the observing station was 40 feet. The net was used open all the way from the bottom to the surface, the catch being thus taken from the whole column of water. In addition to this, catches were taken from the top 20 feet, the top 10 feet, bottom 20 feet, and bottom 10 feet of water. The method of procedure for the bottom 20 feet and the top 20 feet is essentially the same as that for the bottom 10 feet and top 10 feet. To catch the organisms in the bottom 10 feet, the net is attached to the closing mechanism and lowered open, care being taken that the descent is perfectly vertical. It is lowered until the mouth is one foot above the bottom. This is determined by sounding first to note exactly the depth. One can then easily lower the net to the correct point by observing the line paid out, which should be marked off in half fathoms. The net is next drawn

up carefully through 10 feet, and then the messenger sent down the line. This releases the jaw, the ring falls out, and the net is supported solely by the throttling line, which, of course, throttles the net. It can fish no longer on the way up to the surface. One point which must be mentioned here is that as the net could fall suddenly when the messenger reaches the closing apparatus, the line should be hauled rapidly for a second or two so that the throttling rope remains taut whilst coming into action. Hensen is not strictly accurate in stating that a loss of plankton will occur, because the plankton is to be found on the silk and not on the non-filtering part. If the net be used carefully in the still water of a lake, there is no chance of any plankton escaping when the net is released. At the same time it must be observed that the net is an inaccurate method always—practically all our plankton methods are—and the only thing we can do is to make sure that the mode of usage is at least uniform. In Lough Neagh, where the catches were made always in calm water at the same station, with the same depth and in exactly the same way, the risks of non-uniform methods of working were reduced considerably. Certainly, compared with marine work, there can be no comparison of the accuracy. For the bottom to surface catches, the net was simply lowered open and pulled up to the surface open all the way. For the top 10 feet the net was lowered until the mouth was 10 feet below the surface, and then raised open all the way. In every case the catch was collected in the bucket by washing down the net from the outside. It was then removed, and fixed at once (in the boat) in a 5 per cent. solution of formalin.

#### EXAMINATION OF CATCHES.

A rough comparison of the catches may be made by measuring the volumes. This estimation is carried out by allowing the plankton to settle in tubes terminating in a cone. Centrifuge tubes are very satisfactory. The period given should be about a week.

For detailed comparison, however, the method of counting the organisms has been adopted. In any comparisons of plankton catches, the authors consider that counting is absolutely necessary. This unfortunately means great fatigue and huge demands on time. There is no need to detail again the irrefutable reasons for enumeration of the organisms. The reader is referred to Apstein (1905). It is, of course, quite impossible to count every individual in a catch. Millions may be present.

The method adopted by the authors has been therefore to dilute the catch down to 150 cc. of 5 per cent. formalin to which a small amount of glycerine had been added. The glycerine tends to keep the organisms from settling when the mixture has been shaken, and also prevents the drop used in enumeration from drying up too quickly.

The plankton is shaken up in this 150 cc. for about one minute until the organisms are uniformly distributed.  $\frac{1}{10}$  cc. is then removed with a Hensen "Stempel" pipette. This amount is placed on a glass-plate ruled with parallel lines, and with the help of a large mechanical stage the whole drop is passed slowly under the objective. Each organism is enumerated as it passes under the objective. The personal equation in a comparison of catches is eliminated by this method, and such vague and relative terms as 'very rare,' 'rare,' 'common' are deleted. If the number of any species of organism in  $\frac{1}{10}$  cc. of the above dilution was too great to enumerate easily, the species was counted in a greater dilution. Similarly, if there were too few individuals in  $\frac{1}{10}$  cc. of 150 cc. dilution, the catch was filtered and used more concentrated. In every case a factor was noted; and the number of individuals in the count multiplied by the factor gave the number of individuals in the catch. A certain error enters owing to the non-uniform distribution of organisms in the shaken-up catch.

In Hensen's first paper on the method of quantitative plankton investigations instructions were given for a very elaborate counting. There is no wonder that Haeckel, in his "Plankton Studien," remarked, "Wie eine solche arithmetische Danaiden-Arbeit ohne Ruin des Geistes und Körpers durchzuführen ist, kann ich nicht begreifen." Still later it was advised that several plates be counted for each dilution. In practice most of these theoretically exact ways have been abandoned even by the Kiel workers themselves.

We have counted on an average four or five plates for each catch, the dilutions being different according as the species to be counted was frequent or rare.

In order to determine the probable error in the withdrawal of organisms by the pipettes, an organism was adopted which could be easily observed and was not broken up by much shaking. *Ceratium hirundinella* was taken for purposes of the test; and a catch containing this species was diluted until about 140 occurred in  $\frac{1}{10}$  cubic centimetre. A  $\frac{1}{10}$  cc. was abstracted from this diluted catch after proper shaking and the *Ceratium* correctly enumerated. This process was repeated fifty times, the results being as follows:—

146	118	126	146	126
141	132	121	126	136
133	133	123	166	143
144	162	131	125	129
136	136	148	121	129
156	138	135	121	137
149	141	122	159	142
137	125	112	117	157
144	138	141	133	177
143	121	147	122	128

If we arrange these figures, we can determine certain constants which are of great importance. The *probable error*, for example, will give us the measure of unreliability of the counting and abstraction of the samples. To this effect the numbers found in the various counts have been arranged in classes, where five is the number of units in the class-range and 138 has been taken as a mean, though correctly 136.4.

Now, the probable error is given by the formula:—

$$\pm 0.6745 \times \text{standard deviation} = \pm 0.6745 \times \sigma.$$

The standard deviation  $\sigma$  is given by the formula:—

$$\sigma = \sqrt{\frac{\text{sum of } [( \text{deviation of class from origin} )^2] \times \text{frequency of class} - (\text{distance from origin to mean})^2}{\text{number of variates};}}$$

$$\sigma = \sqrt{\frac{\sum(x^2 \cdot f)}{50} - \bar{x}^2.}$$

$$\text{This is } \sqrt{\frac{9225}{50} - (1.6)^2} = \sqrt{184.5 - (1.6)^2}$$

$$\therefore \sigma = 13.49.$$

$$\begin{aligned} \text{The probable error} &= \pm 0.6745 \times 13.49 \\ &= \pm 9.1029 \end{aligned}$$

Thus we have a figure showing to what extent the number of *Ceratium* in one of our counts is probably correct.

The probable error in the withdrawal of organisms by the pipette and the quantitative enumeration by counting is small, but at the same time is greater than it ought to be. We may take from the above, however, that for this particular case a difference of about 30 above or below the mean in a count would be required before we could assume an actual difference in the constitution of the catch. We are not aware that a series of experimental counts with a plankton organism has been worked out before in this way.

From a paper in "*Biometrika*," vol. v, p. 351, it would appear that in such counts as ours the  $\sigma$  should =  $\sqrt{\frac{m}{M}}$ , where  $m$  is the mean number per unit volume and  $M$  is the number of unit volumes counted. This in our case is  $\sqrt{\frac{136}{1}}$ , but  $\sqrt{136}$  is rather different from  $\sqrt{132}$ , and shows there was some heterogeneity in our samples.

The serious errors in quantitative work are in the process of catching by means of net or other apparatus. It is obvious that unless the organisms are more or less uniformly distributed in the water horizontally, the sample

abstracted by a haul of the net will not be a fair sample of the constitution or quantity of the plankton at the time. This was the grave objection brought against the quantitative work by Haeckel in his "Plankton Studien." Haeckel asserted that the planktonic organisms occurred in swarms. Hensen, on the other hand, upheld the view that where hydrographical conditions were uniform the plankton would be found to be distributed uniformly. By this he recognized vertical distribution, and, what most of his critics forget, the possibility of a non-uniform distribution where the hydrographic conditions are variable.

It would be outside the limits of this paper to discuss the opinions brought forward on this subject. Amongst the foremost workers must be included Herdman; and one of the authors of this paper has spent some very considerable time working with him on the marine plankton of the Irish Sea.

Herdman has demonstrated the non-uniform distribution in that area, but has shown that by an intensive study with stations a few miles apart we may still follow out changes in the plankton quite easily. We must emphasize the fact, however, that the Irish Sea as a whole is a stretch of moving water under all kinds of variable factors. It is impossible to take the catches at the same time each day without taking them under very different tidal conditions. The water our catches were taken from yesterday has moved away to some new place to-day. Our conditions of light at the time of taking the catches may have had no effect on the plankton, which has perhaps been affected by the meteorological conditions of some other place when the water was in that region. Furthermore, the plankton includes numerous pelagic larvae, of bottom animals which have, as everyone would expect, a very non-uniform distribution. In fresh-water lakes all these sources of error are absent. We have the very best conditions for quantitative work and the elucidation of plankton problems. We deal with the same water, and can follow out all the meteorological conditions to which it has been subjected.

Now, it may be said that at the present time most practical workers agree with the views supported and discussed by Apstein, Lohmann, Zacharias, Burckhardt, and Diffenbach, that the horizontal distribution is uniform. The same applies to Lough Neagh outside the littoral regions. Thus in a lake like Lough Neagh we may take our catches as giving a true picture of the conditions prevailing. Were great differences in uniformity present, they would have affected the curves to an obvious extent. In any case the variations in constitution of the plankton which have been taken as seasonal are quite distinct from accidental variations due to inaccuracy in catches.

The following list gives the weather conditions prevailing at times of making catches. The midnight catches are not included in this series :—

1910.

- Febr. 23, . Time 2.0 p.m. Brilliant sunshine. Blue sky. Sea moderate. Breeze fresh S.W. Previous days, heavy rain. Depth of water 40 feet at station.
- March 5, . Time 2.0 p.m. Brilliant sunshine. Wind S.E. to E. and fresh. Sea calm. Surface temp. 4.4°.
- March 17, . Time 2.30 p.m. Cloudy. Sea rough. Wind W. strong. Surface temp. 5.5°C.
- March 30, . Time 2.30 p.m. Brilliant sunshine. No wind. Calm.
- April 13, . Time 3.0 p.m. Cloudy, previous day dull and heavy rain. Sea calm. Wind fresh N. Plankton deep blue in colour. Surface temp. 7.7°C.
- April 27, . Time 2.45 p.m. Dull. Rain. Much wind S. Previous days, similar weather. Surface temp. 8.6°C.
- May 11, . Time 2.50 p.m. Brilliant sunshine. Hot after several days of rain, hail, and snow. Sea moderate. Wind strong S.E. Colour of plankton again different—now yellow-green. Surface temp. 9.5°C.
- May 25, . Time 3.15 p.m. Brilliant sunshine, after hot weather. Sea calm. No wind. Surface temp. 14.3°C.
- June 10, . Time 3.0 p.m. Brilliant sunshine, after previous days of rain and wind (three fine days before the 10th). Sea choppy. Wind strong N. Depth of water now only 38 feet. Surface temp. 15°C.
- July 13, . Time 2.55 p.m. Brilliant sunshine. Surface temp. of H<sub>2</sub>O highest recorded 20°C. Sea calm. Wind slight N. Plankton yellow.
- July 27, . Time 3.0 p.m. Brilliant sunshine. Blue sky and clouds. Wind fresh S. Sea calm. Surface temp. 16.5°C.
- August 18, . Time 2.30 p.m. Sea rough. Wind S.S.E. Very dull and much rain. Surface temp. 17.3°C.
- Sept. 8, . Time 2.0 p.m. Brilliant sunshine. Blue sky. No wind. Previous days similar. Thick water-bloom. Surface temp. 17.5°C.
- Sept. 29, . Time 2.15 p.m. Dull. Slight breeze S.W. Calm. Surface temp. 14.5°C.
- Oct 21, . Cloudy. Wind light E. Sea calm. Surface temp. 12.0°C.

1910.

Nov. 11, . Sun and clouds. Previous weather cloudy. Sea calm. Wind light S. Rain and very rough weather for previous fortnight. Surface temp. 7·5°C.

Dec. 2, . Bright sun. Clouds. Strong east wind. Sea variable (wind off land). Frost on previous days. Surface temp. 5·0°C.

1911.

Jan. 12, . Sun at intervals. Wind S.W. Some rain. Sea moderate. Surface temp. 4·6°C.

Febr. 3, . Bright sun. Sea calm. No wind. Surface temp. 5·0°C.

## DISCUSSION OF INDIVIDUAL SPECIES PRESENT IN THE PLANKTON OF LOUGH NEAGH.

### PHYTOPLANKTON.

The species of algae occurring in the plankton of Lough Neagh are as follows:—

#### **Tabellaria.**

*Tabellaria fenestrata* var. *asterionelloides* Grunw.—*Tabellaria* is undoubtedly our most characteristic plankton organism. It occurs in prodigious quantities, and is easily first on the year's catches. At times the plankton is almost entirely composed of this form. Another extremely interesting point is that *Tabellaria fenestrata* always occurs in the "star" colonies. One or two very isolated chains have been found in the millions of stars. These results differ greatly from those observations on the lakes of Denmark, where *Tabellaria* is rare everywhere as a plankton organism, and occurs both in chains and in stars.

In Ennerdale Water in the English Lake District the star-shaped form of colony is practically absent; in Wastwater it is entirely absent. In Lough Lomond, which, so far as *Asterionella* is concerned, presents some agreement with Lough Neagh, we find *Tabellaria* occurring more frequently. West's data do not allow of a comparison so far as numbers are concerned, but there is nothing to show that *Tabellaria* var. *asterionelloides* ever attains the position which it occupies in August in Lough Neagh; and we never find the chain form which is present in Loch Lomond.

Moreover, *Coelosphaerium* is the dominant form in Lough Lomond when *Tabellaria* is at its maximum. This is not the case in Lough Neagh. In Lough Neagh the number of *Tabellaria* present drops after August; but it remains quite common *all the year round*, and though a minimum occurs in

[F 2]



March (agreeing with Lough Lomond), the number of colonies in the bottom and surface catch was 55,000, so that it could not be said to be rare even at that time.

*Tabellaria fenestrata* has been recorded by some observers to occur in chains in winter and stars in summer (Bally for the Zurichsee). For form-variation in Lough Neagh see p. 68.

*Tabellaria fenestrata* is one of the characteristic diatoms of the Arctic lakes. It is somewhat rare in Central European lakes. It turns up again, however, in the Alpine lakes of Switzerland, and has been recorded as occurring in enormous quantities, just as in Lough Neagh, in Zurich See by Schroeter. It has also been noticed in the brackish water of the North Sea. Schroeter makes an observation of some interest on the quantity of plankton in the Zurich See when mostly *Tabellaria*. He estimates that at this period for a depth of 8 metres, 1 square metre of surface water corresponded to about 1000 cc. of plankton. It would have required a goods train with seven waggons to have removed the dry plankton, while the silica present would have been sufficient to have made a quartz block 2.25 metres square with a weight of 303.8 cwts.

*T. fenestrata* Kütz occurs in the waters of the Illinois River, but the variety *asterionelloides*, common in Lough Neagh, is not recorded by Kofoid. The species was only found on one occasion in the Illinois River.

#### **Asterionella.**

*Asterionella gracillima* and *A. formosa* both occur in the lake. They have been united, as it is very probable that they are only variations of one and the same species. *A. gracillima* was by far the most frequent form, *A. formosa* being present in an almost negligible quantity.

*Asterionella* is extremely common in the plankton of Lough Neagh, and is present all the year round. The minimum with us occurs during early March. A maximum occurs during the summer months from May to August, and the numbers fall gradually to March. The maximum number obtained in a bottom-to-surface haul was practically 2,000,000; the minimum was 20,000. The individuals occur at all depths, but more commonly in the surface waters.

The maximum of the diatoms seems to be largely influenced by temperature, probably with light and other unknown factors aiding. Usually the chief maxima occur at temperatures below 15° or 16° C., and in the Irish Sea diatoms are rare in the summer months. *Asterionella* seems capable of having a maximum at any temperature. Thus Wesenberg Lund records a curious maximum which took place just before the freezing or immediately after the



breaking up of the ice in December and lasting through January. No maxima occurred, however, at the time in those lakes which did not freeze. Lough Neagh did not freeze during the year of our visits; and as will be seen from the tables, the numbers present in the winter months are not far removed from a minimum. The usual dates for maxima given by other observers agree with that for Lough Neagh—July–August. These dates are recorded by Lemmerman, Wesenberg Lund, and the Messrs. West. In Loch Lomond, just as in Lough Neagh, the maximum occurs in June–August, and is associated, just as with us, with *Tabellaria*.

There is, however, considerable difference in the two types of lake. Our curves for *Asterionella* agree almost exactly with those of Messrs. West for Loch Lomond. In Windermere, on the other hand, there are two maxima recorded for *Asterionella*, one in May–June, and another in November. Ennerdale Water is again very different, and this is a Desmid lake. Form variations are recorded elsewhere (p. 68).

*A. gracillima* and *A. formosa* both occur in Illinois River, the latter being very much less abundant than the former.

*A. gracillima* attains its maximum about the end of April, there being no autumnal maximum. It practically disappears from the plankton in July until January.

*A. formosa* was recorded by Kofoid in November–December, and from February to April. The maximum occurred towards the end of March. He remarks that “this species is distinguished with difficulty from *A. gracillima* and may include only old, and in our planktons often heavily incrustated, individuals, or it may be only a low-temperature variety of the species above named, which, in the grand total of all our collections, outnumbered it ten thousand to one.” We are inclined to agree with this statement, as our observations of these species in Lough Neagh point to the same conclusions.

#### Melosira.

*Melosira italica* subsp. *subarctica* O. Müller.

*islandica* „ *helvetica* O. Müller.

*crenulata* Kütz.

*varians* Ag. bottom species.

*arenaria* Moore.

The above species have been recorded by us from Lough Neagh. The three last are also recorded by West with the addition of *M. granulata* (Erent) Ralfs. We have considered all the species together in our counts. The most common appear to be the three first-named above.

*Melosira* occurs throughout the year, but differs from *Asterionella* and *Tabellaria* in the great variation in quantity. Thus, for example, it vanishes almost completely from September until February, that is, during the winter months. Our maximum occurs in late February and early March, and continues more or less towards the end of May. There is, however, only one maximum, and no other maximum appears in October or September as recorded by Apstein and Wesenberg Lund. In the same months, from June onwards, *Melosira* is remarkably scarce with us.

In the English lakes, Messrs. West record *Melosira* as completely absent from Ennerdale Water. It is very rare in Wastwater. On the other hand, the figures for Windermere agree almost exactly with those for Lough Neagh, there being one maximum in April. In Loch Lomond *Melosira* is abundant and dominant in June. At this period, moreover, a *Melosira* plankton is present, and this never occurs in Lough Neagh. *Melosira* is one of the Central European forms, and occurs chiefly in shallow and warm lakes. In no other case do the observations on times of maxima show such remarkable variation according to district. Thus the maximum has been recorded in November, December, September, October, June, April, February, July, and May. *Melosira* has often been noted as forming the food of crustacea—*Bosmina*, *Daphnia*, and *Diaptomus*.

Kofoed records *M. granulata* var. *spinosa* and *M. varians* from the Illinois River, the former being very much more abundant. *M. varians* is perennial, and exhibits two well-defined maxima, a vernal one in April–May and an autumnal one September–October. In July and August, 1894, 1895, and 1896 it was almost absent, also in December, February in 1896–97 and 1898–99.

#### **Fragilaria.**

*Fragilaria crotonensis* is the only species that we have met with in the plankton of Lough Neagh. This form was present throughout the year except February, 1911. It was present, however, in considerable quantity in February, 1910. The maximum occurred in March–April, and then the numbers went down during May, June, and the first half of July. The numbers were again up in August. The early maximum agrees with that found by other workers, but occurred much earlier than is usually the case (May onwards, Wesenberg Lund for the Danish Lakes, and July onwards, Lemmerman for Plöner Sea). If the increase in July and August can be called a second maximum, it is earlier again than the second maximum recognized on the Continent in September. Obviously the Lough Neagh conditions are very different from those observed in the Baltic and Danish lakes.

*Fragilaria crotonensis* is recorded as occurring commonly in the Central European lakes. In Lough Neagh it is quite common. Now we find a striking contrast to this in England and Scotland. In Messrs. West's records the genus is absent from Ennerdale Water. The species *Capucina* is the only one present in Wastwater, and is rare there, and this species is again the only one, and rare in Loch Lomond. Thus there is a marked difference between the Scottish lakes and Lough Neagh. *F. crotonensis* is recorded as occurring in Lough Neagh by West, and also, in another paper, Proc. Roy. Soc. 81 B, in Scottish and English lakes. It is added, however, that "Fragilaria is somewhat rare, and of the species which occur *F. capucina* is the commonest." This does not hold good for Lough Neagh. Kofoid records *F. crotonensis* from the Illinois River, where it is much less abundant than the species *F. virescens*. It is predominantly a vernal plankton, having its maximum on May 10th. It appeared in February and disappeared after May 17th. In other years it was only found in April, May, and December.

#### **Coscinodiscus.**

*Coscinodiscus lacustris* Grun.—The order Centricae, on the whole, includes a small proportion of the Diatoms, and only a few fresh-water forms. The family Coscinodiscaceae includes only three genera inhabiting fresh water in the British Isles; and it is noteworthy that all three occur in the plankton of Lough Neagh—*Cyclotella*, *Stephanodiscus*, and *Coscinodiscus*. Only one species of the latter genus occurs in fresh water in the British Islands, and that not always in the plankton. Now, in Messrs. West's records of the Scottish lakes and English lakes, *Coscinodiscus lacustris* is recorded as absent. In Wesenberg Lund's great treatise on the plankton of the Danish lakes, no mention is made at all of *Coscinodiscus lacustris*. It is not recorded by Apstein for the lakes at Plön.

Thus it is, perhaps, one of the most remarkable features of Lough Neagh to find that *Coscinodiscus lacustris* occurs in very considerable quantities in the plankton. The species seems to be present right through the year, with a maximum in spring. The highest numbers occurred in March and April; the smallest in the months September to February. In the marine plankton, *Coscinodiscus* is one of the most important diatom genera. *Coscinodiscus* is not recorded by Kofoid from the waters of the Illinois.

#### **Stephanodiscus.**

The genus *Stephanodiscus* is represented by the species *astraea* in the plankton of Lough Neagh. Like *Coscinodiscus*, this genus is not recorded from the Scottish Lakes (except by Bachmann) or the English lake district.

Unlike *Coscinodiscus*, however, it occurs in some considerable quantity in the Danish lakes; and Wesenberg Lund states that it seems to be of much more importance there than in lakes abroad. It has also been recorded from the Swiss lakes and the Central European lakes, but does not appear to be common.

The maximum occurs in spring, the highest numbers being found in April. It remains common until August, and then the number falls rapidly, so that practically none were present in September, and extremely few from that time onward until February.

*Stephanodiscus astraea* seems also to be an Arctic plankton diatom. This species is not recorded by Kofoid from the Illinois River.

#### **Cymatopleura.**

The genus *Cymatopleura* is represented by the species *elliptica* and *solea*. The species *elliptica* is far the most common, and for this form curves have been made for the year. Wesenberg Lund records *Cymatopleura elliptica* as a bottom diatom, occurring, however, as a typical plankton organism. Perhaps the shallowness of Lough Neagh has something to do with the relative abundance of *Cymatopleura* as a plankton organism.

*Cymatopleura elliptica* occurs all the year round in the plankton, and the range of variation is not very high. The maximum occurs in July and August, at the same time as the small second maximum of *Fragilaria*. The numbers are also high in February and March, although not as high as the July and August maxima. After September there is a great decrease, and the number then remains about constant and small until the spring.

*Cymatopleura* does not occur in the English or Scottish lakes investigated by Messrs. West, but has been recorded by them for Lough Neagh and the Orkneys and Shetlands.

A species of *Cymatopleura* occurs in Victoria Nyanza. *C. elliptica* occurs in European and Alpine lakes. Kofoid records *C. solea* from Illinois River, where it occurs in small numbers during the colder months, with also some isolated individuals in the summer months.

We have observed it as isolated specimens in April, May, June, and October.

#### **Surirella.**

*Surirella biseriata* is the most common species in Lough Neagh plankton; though *S. ovalis* Bréb., and *S. robusta* Ehrenb., also occur, the latter often in considerable quantity.

This genus is fairly common in the plankton, but is inferior in numbers to most of the algae which were present in such quantity as to be easily

followed throughout the year in our counts. The maximum numbers occurred in April, the total for all catches being 35,000 on the 13th April. This number may be compared with the maximum numbers of the following:—

Asterionella, . . . . .	2,722,500
Tabellaria, . . . . .	78,810,000
Fragilaria, . . . . .	819,000
Stephanodiscus, . . . . .	103,500
Coscinodiscus, . . . . .	1,540,000

The spring maximum of the *Surirella* extends from February onwards until May. A great depression occurred in June and July, and was then followed by high numbers again in late July and August. After this the numbers diminished considerably, though the genus was always present.

*Surirella biseriata* is recorded as rare in Ennerdale Water, and present in December, January, March, May, and June. In Wastwater it was present chiefly in February. In Loch Lomond, April was the month for *S. biseriata*, and later August. *S. robusta* var. *splendida* also attained its maximum in the months of March and April. On the whole, *Surirella robusta* var. *splendida* appears to be the most common form in the British lake plankton.

*Surirella biseriata* is recorded for the Danish lakes, and lakes of Central Europe and the Alps. Kofoid records only the *S. ovalis* and *S. spiralis* from the Illinois River.

#### Synedra.

*Synedra Revaliensis* Lemm.—This species, which is now recorded for the first time from Lough Neagh, has been the most interesting species of *Synedra* in the plankton. In the first place, other species occurred so very rarely that they did not come out in the counts at all. This species was unrecorded for all the months from the first catches made in February to end of May. On June 10th it first appeared, and then was present only in the bottom water of the lake. The numbers steadily increased until August, when a maximum was reached quite suddenly—37,500 colonies were present in the top 20 feet catch alone! 30,000 colonies were present in the bottom 20 feet. Thus, on this date, more colonies were present in the surface catches. This sudden maximum was followed by just as sudden a fall, and whilst it was recorded for the surface catches in October, the number was only 300. After this date it disappeared once more. In no other case, except *Dinobryon* and *Peridinium*, were such a sudden appearance and maximum observed in the phytoplankton of the lake.

*Synedra Revaliensis* occurs in lakes in west and south-west Ireland (Messrs. West); but this is not recorded for Scotland and England.

Very few diatoms have a maximum in the height of the summer, as this species of *Synedra* appears to possess. Another interesting feature is the marked origin from the bottom of the lake and the gradual ascent to the surface waters. The *Synedra* species recorded by Wesenberg Lund for the Danish lakes attain their maxima in April and May.

In all cases *Synedra Revaliensis* occurred with us in the form of star-shaped or radiating colonies.

Kofoed does not record this species from the waters of the Illinois River.

#### **Pleurosigma** W. Sm. *Gyrosigma* Hassall.

*Pleurosigma attenuatum* Kütz occurs in the plankton of Lough Neagh in small numbers. The highest numbers occur in July and August, viz. 16,500 in the combined catches. It diminishes during September and October, and is absent altogether during November, December, and January.

Messrs. West do not record *Pleurosigma* in their paper on the seasonal variation in the British lakes examined by them. They have observed it in the plankton from the Orkneys and Shetlands and from west and south-west Ireland.

Neither Wesenberg Lund nor Apstein makes any mention of *Pleurosigma*.

### **CYANOPHYCEAE.**

The Cyanophyceae play a great part in the plankton of Lough Neagh, and in this respect we find Lough Neagh agreeing with the Danish lakes. Just as in the Danish lakes, we have few species but large numbers of individuals; and at times the phenomenon known as "water-bloom," or the "breaking of the meres," is produced by rapid reproduction on calm days, when the organisms can concentrate in the upper inch of surface-water.

#### **Oscillatoria.**

*Oscillatoria Agardhii* Gomont. is the most frequent of the *Oscillatoria* in Lough Neagh. This is not recorded for Lough Neagh by Messrs. West, though they have noted its presence in other lakes in Ireland, and in England and Scotland. The dominant species is *O. rubescens* De Candolle.

The Cyanophyceae are characteristically summer plankton forms, though sometimes a maximum occurs in the winter months. *Oscillatoria Agardhii* reaches its maximum with us in May. It was present in large quantities, however, in March, April, May, June, and July; and with *Anabaena* was responsible for "water-bloom" on March 30th. This date is early for water-bloom, and the phenomenon was not nearly so well marked as in late summer.



*Oscillatoria rubescens* has been discovered to be dangerous to the fishery in Zurich See. The filaments form a kind of network with mud over the fish-eggs on the bottom, and prevent the eggs from reaching the hatching-point, or suffocating the young larvae. As a matter of fact, more than one blue-green alga has been considered as a dangerous element in lakes; and though it is not known to what extent the development of these forms has increased or remained stationary in Lough Neagh, it will be well to remember that they occur in considerable quantity at present.

The smallest quantity of *Oscillatoria* is present in the months of September to January; and, as a matter of fact, the genus seemed to be totally absent from the plankton in January, 1911.

*Oscillatoria Agardhii* is recorded by Messrs. West in their seasonal studies of the plankton of the English and Scottish lakes. It is, however, never recorded as more than rare. It is usually absent during many months of the year, and it seems to appear in very different months in different lakes. Against this, it is one of our most common species in Lough Neagh, and present almost the whole year through.

Under the heading *Oscillatoria* spp. Kofoid includes several species which may include *O. Agardhii*, Gomont, although no special mention is made of this form. *Oscillatoria* occurred in every month of the year until the 1st of October. The seasonal curve is most irregular and variable, and Kofoid regards it as a possible adventitious or only temporary plankton.

#### **Anabaena.**

*Anabaena* is represented in Lough Neagh chiefly by the species *flos-aquae* (Lyngb.) Bréb., though *A. Lemmermanni* is also recorded by Messrs. West.

The Cyanophyceae are on the whole characteristic of Central European lakes, and are absent from the Arctic lakes. *Anabaena Flos-aquae* is, however, recorded from north Sweden and Russian Lapland. It is common in the Central European lakes and the Danish lakes. In Messrs. West's latest paper it is only recorded for Loch Lubnaig in Scotland, and is then noted as occurring only in August. It has, however, been recorded by them for lakes in all parts of the British Islands. There is no doubt that it is on the whole very rare in the Scotch and Welsh lakes. It is, on the contrary, very common in Lough Neagh, and is present in every month of the year. The maxima occurred in April (15,000,000 filaments in all catches), but high numbers were present through February, March, April, May, and June. The numbers were lower in the hot months of July, August, September, October, and very low from November onwards until January. In the Danish lakes the maxima occur later; in June and in the case of other species the maxima synchronize with the

[G 2]

time when the water attains its highest temperature. During the winter months *Anabaena* seems to be absent from the Danish lakes altogether.

*Anabaena spiroides* is the only species recorded from the waters of the Illinois by Kofoid, where it occurred in the water-bloom from June to October. The data were insufficient for determination of maximum.

#### ***Gomphosphaeria Naegeliana* (Unger) Lemm.**

The species *Gomphosphaeria Naegeliana* (Unger) Lemm. occurs in enormous quantities in the Lough Neagh plankton. It is probably either the *Coelosphaerium Kutzingianum* of Messrs. West or *C. Naegelianum* Unger of their records. They state, however, that *C. Naegelianum* Unger is probably only a form of *C. Kutzingianum*. They record both, and there seems to be some little confusion about the name of the genus.

Lemmermann himself has identified our specimens, and states that *G. Naegeliana* is quite different from *C. Kutzingianum*. It is, as a matter of fact, a different genus, *i.e.* *Gomphosphaeria*. The cells of *G. Naegeliana* are oblong or obovate, and are fastened at the ends of branched hyaline gelatinous stalks. The cells of the *Coelosphaerium Kutzingianum* are globose, and there are no stalks. The cells are arranged just within the periphery of the colony.

Wesenberg Lund only refers to *Coelosphaerium Kutzingianum* in the Danish lakes; but we should not be surprised if this is the same as our species *G. Naegeliana* of Lough Neagh.

*Gomphosphaeria Naegeliana* occurs in large quantities throughout the entire year in Lough Neagh. Its curve shows two maxima. The numbers rise in March, and a small maximum with 1,317,500 colonies (all catches added) is reached in April. The numbers then fall slightly to about an average of 400,000 for the months of June, July, and August, and then an enormous increase takes place. In November the number of colonies in all catches was 13,646,500; and this maximum lasted throughout December. The maximum in November was responsible for water-bloom and also in September. As a matter of fact during the period September to November, any succession of very calm days brought up the alga to the surface. The lake seemed covered with a green layer blown into long streaks by the wind. Our maximum for *Gomphosphaeria* seems to be remarkably late. *Coelosphaerium* is usually recorded for autumn; but Messrs. West give for Loch Lomond August, September, October, and November. In Loch Katrine it appears from their figures to be most common in August and September. It is recorded for the English lakes by Messrs. West (Proc. Royal Soc., 1908), but appears to be



absent from the lakes investigated in the lake district in their research on the seasonal changes (Linn. Soc. Jour., 1912). *Gomphosphaeria lacustris* is however, present. Wesenberg Lund records this alga as being rare in April and May and reaching its maximum in autumn.

*C. Naegelianum* has been recorded from Russian Lapland, and so occurs in the Arctic lakes. It is remarkably common in many Central European and Baltic lakes. The species is recorded from certain of the alpine lakes—Katzen See, Zurich See, etc. *Coelosphaerium* is stated to be absent from the African lakes.

On the whole, Loch Lomond seems to resemble Lough Neagh so far as *Coelosphaerium* is concerned more than any other lake, for which we have details, in the British Isles. There, for example, we find *C. Kutzingianum* almost all the year round and attaining a maximum in September–November, with low period in December–January. Messrs. West state that it occurs in slightly contaminated lakes. No record is given of this genus by Kofoid from the Illinois River.

**Microcystis** Kütz. (*Polycystis* Kütz. *Clathrocystis* Henfrey.)

*Microcystis* is represented in Lough Neagh by the species

*M. firma* (Bréb. et Lemm.).

*M. aeruginosa* Kütz.

*M. holsatica* Lemm.

*M. firma* and *M. holsatica* are recorded for the first time for Lough Neagh. *M. prasina* (Wittr.) Lemm., *M. stagnalis* Lemm., and *M. roseopersicina* (Kütz), West, are recorded by Messrs. West in addition to the above. We have for purposes of this report added the various species together.

*Microcystis* is never common in Lough Neagh. It reaches a maximum in February of 41,600 in the bottom-to-surface catch, and diminishes rapidly. It is very rare from September to February.

Wesenberg Lund records *M. aeruginosa* and *M. flos-aquae* in all the Danish lakes examined except Esromso, in which the former alone occurs. It reaches its maximum in July, which may be very high. It is absent from Ennerdale Water, Wastwater, Loch Earn, and Loch Lubnaig.

*M. elabens* and *M. flos-aquae* both occur rarely in Loch Lomond in October and November and in August respectively. *M. flos-aquae* occurs in very small quantities in June in Loch Katrine.

Never in Lough Neagh, so far as we know, does *Microcystis* form "water-bloom." This is not the case on the Continent, where it often is the characteristic blue-green alga occurring in water-bloom. It has been observed on

the Continent, too, that a great development of *M. aeruginosa* accompanied by "water-bloom" phenomenon was followed by the death of the fish. This was probably due to the decomposition gases.

*Microcystis* is absent from the arctic lakes. It is very rich indeed in the Central European lakes, while it occurs and forms water-bloom in Alpine lakes. *M. aeruginosa* appears to have a very wide range, and occurs in the lakes of Ceylon.

*Clathrocystis aeruginosa* (Kütz.) Henfr. is present in the Illinois plankton, where it is predominantly a midsummer species. It attains its maximum in August and September (108,000). It is not very abundant, *Microcystis ichthyolabe* being much more frequent. Other species may have been counted with the latter owing to the lack of striking characteristic differences. *M. ichthyolabe* attains a maximum in August–September or September–October, and is present throughout the year.

#### Chroococcus.

*C. limneticus* Lemm. is the only species of the genus which is at all common in Lough Neagh, though *C. minimus* also occurs. Most species of *Chroococcus* are not found in the typical plankton of large lakes. It can hardly be called common in Lough Neagh; 3600 colonies was about the largest of the bottom to surface catches in August. It was absent altogether or else present in very small quantities indeed in April, May, January, and February. Messrs. West say that it was very abundant in Lough Neagh. Their catches probably represented the maximum time of occurrence, July or August, though it was certainly never abundant in our year of examination.

*C. limneticus* occurs in the Danish lake plankton, but is never abundant and appears to reach its maximum during the winter. Wesenberg Lund adds that if this is the normal it differs from all the other *Cyanophyceae* which reach maximum usually at higher temperatures. Our largest numbers seem to occur in summer, though a very large catch was made in February. (February catch abnormal—new net.)

*Chroococcaceae* seem to be very abundant in some of the African lakes. *Chroococcus turgidus* has been recorded from arctic lakes in Russian Lapland.

#### DINOFLAGELLATA.

##### Ceratium.

The genus *Ceratium* is represented in our plankton by the species *C. hirundinella*, and perhaps no other fresh-water protozoan or protophyton has been so much discussed as this organism. Whilst *Ceratium* is represented by

many marine species, there are only two fresh-water species; and one of these, *C. cornutum* Clap. and Lachm., is a pond-form and does not occur in Lough Neagh. Ceratium is apparently absent in January and February alone. We say apparently because it was only after the investigation of a large quantity of December plankton that some odd individuals were found. It is very probable therefore that a few isolated individuals occur right through the year. In many lakes *C. hirundinella* is known to be altogether absent in the winter months. Wesenberg Lund states that it begins to appear in May in the Danish lakes. We have found a few resting cysts, and probably in this form as well as in isolated individuals the genus survives through the winter. It appears in definite numbers in the Lough Neagh plankton in March, but it is then very rare. A gradual increase takes place from this time until its maximum is reached in August. At this time it is one of the organisms occurring in greatest numbers in the plankton. Its maximum coincided with the maximum of Tabellaria and Asterionella; otherwise it would have been the most numerous organism in the plankton. As it is, it practically comes second. Both three-horned and four-horned individuals occur; but the four-horned is by far the most common when the maximum is reached.

For details of the form-variation, reference should be made to p. 69, where this has been discussed.

After the maximum in August, the number drops very suddenly (from 2,086,500 individuals in all catches to 233,710 on September 8th). There are about as many present in October as in June. Thus *C. hirundinella* has one very definite maximum, and this agrees with the marine species in occurring in the warmer months.

Apstein records *C. hirundinella* in the Baltic lakes, where it has one maximum in the summer months and is absent during the winter. Messrs. West record *C. hirundinella* from the Scottish lakes, Orkneys, and Shetlands, west and south-west Ireland, the Welsh lakes, the English lakes, Lough Neagh, and Lough Beg.

In Ennerdale Water it is common in September and October, when it reaches its maximum. There is a smaller maximum during June and July. The species is absent from December to April. It does not occur in Wastwater at all. *C. hirundinella* is present in Loch Lomond, but not common. The maximum for this lake is attained in September. The species is absent altogether from November to May.

*C. hirundinella* does not appear to be present at all in Loch Katrine, whilst in Lough Earn it is only recorded for August, and even then it is rare. Messrs. West do not find it in Lough Lubnaig.

Wesenberg Lund states that *C. hirundinella* appears in May in the Danish lakes, and its maximum coincides with the highest temperatures of the water. During September and October it disappears, often very suddenly. The species is present in large quantities in the Baltic lakes.

The Dinoflagellata, on the whole, play only a secondary part in the arctic lakes. The species *C. hirundinella* occurs in the lake of Enore in the three-horned form and without seasonal variation. Richard found three- and partly four-horned individuals.

*C. hirundinella* is the chief Dinoflagellate found in the European alpine lakes, where it occurs in large quantities. The same species occurs also in quantities in the north European lakes, in Iceland and in the Faröes. Kofoid records it from the Illinois River during the summer of 1896, but not in 1898. It was present from June to October, and attained its maximum (19,200) on June 6th.

#### Peridinium.

West records the species *P. Willei*, *P. tabulatum*, and *P. cinctum* from Lough Neagh. The species *P. tabulatum* and *P. cinctum* alone occur in sufficient quantities for counting purposes. The genus is at no time very abundant; and from the latter part of September until April it has not been observed in the plankton. In August the maximum, 54,000, is reached, in the bottom-to-surface catch. This occurs quite suddenly, as in July and September there are not more 6,000 individuals present in the catch.

West records *P. inconspicuum* and *P. Willei* from Ennerdale Water. The former occurs from May to November, with its maximum in August; the latter occurs from January to July, with its maximum in July. In Wastwater, *P. Willei* occurs throughout the year, and attains its maximum in July. In Loch Lomond it is absent from November to April, and reaches its maximum in September. In Loch Katrine *P. Willei* is absent from October to February, and reaches its maximum in July. It is present in Loch Earn and Loch Lubnaig in August.

In the British lakes Peridinium, although generally present, never occurs in very abundant quantities, and its maximum occurs at different times in the various lakes.

Wesenberg Lund finds that in the Danish lakes *P. tabulatum* attained a large maximum in April and a smaller one in October. *P. cinctum* is also present in the Danish lakes. According to Apstein, *P. tabulatum* appears in April in the Plöner Sea and Dobersdorfen Sea, and reaches its maximum in July. It disappears towards the end of November.

In the arctic lakes the Dinoflagellata are unimportant, but *P. Willei*, *P. cinctum*, and *P. umbonatum* have been recorded.

*P. Willei* occurs in the plankton of the north European lakes and also other species. It seems to be absent from the Baltic lakes, its place being taken by *P. cinctum*, while other species also occur. They rarely attain a large maximum. In the central European alpine lakes *P. tabulatum* is recorded as common.

We see that although Peridinium is widely spread, it is nowhere very abundant.

*P. tabulatum* is recorded from the Illinois River by Kofoid. It is perennial, although rare, during the cold months. It attains its maximum about July or August. It plays quite an insignificant part in the plankton of this river.

#### DINOBYRYON.

This genus is represented in the Lough Neagh plankton almost entirely by *D. cylindricum* var. *divergens* (Imhof) Lemm. *Dinobryon protuberans* and *D. sertularia* var. *thyrsoides* also occur, but in such small quantities that it is not worth while counting them separately. As a matter of fact, there seems at present to be great confusion amongst specialists as to the different species, and temporal variations require to be worked out. In Lough Neagh Dinobryon is not a very abundant constituent of the plankton until July is reached, when it attains a maximum of 462,000 colonies (in all the catches of the day combined). It is absent altogether from September to March, and does not begin to increase very much until June.

Messrs. West record species of Dinobryon from Ennerdale Water, Wastwater, Loch Lomond, Loch Katrine, and Loch Lubnaig, but they are exceedingly rare, and occur only during a few of the summer months, and then only in very small quantities. The genus appears to be more common in Loch Lomond and Loch Lubnaig in September and August respectively.

The Danish lakes are poor in Dinobryon, though a great *spring* maximum has been known to occur in May in certain lakes. Apstein found great quantities of Dinobryon in the Baltic lakes. Two species predominate, *D. divergens* and *D. stipitatum*. He found the genus common in one lake in April, and it increased steadily until June was reached. There was a great recession in July, and only a few were present in September. In another lake, however, the numbers were greatest in June and July, when ten individuals were present in every cc. of water, or a colony of twenty individuals to every 2 cc.

Lauterborn finds a maximum in May, and even finds what may be termed a Dinobryon plankton. His numbers diminished during June, July, and August, but there was a second maximum in October. Apstein, as the result

of investigations, divided lakes into Chroococcus and Dinobryon lakes. The characteristic conditions are stated by him to be as follows:—

	Chroococcus lake.	Dinobryon lake.
Chroococcaceae, . . .	common, . . .	rare.
Dinobryon, . . .	none or rare, . . .	numerous.
Chydorus, . . .	pelagic, . . .	littoral.
Plankton in general, . . .	rich, . . .	poor.
Water, . . .	muddy, . . .	clear.

One of the first objectors to this theory was Zacharias. Apstein states that if there is much Clathrocytis, for example, in a lake there is little Dinobryon. Reighard, however, for St. Clair, showed that the features were not as Apstein's theory would have made them. He found

Clathrocytis, . . .	common.
Dinobryon, . . .	common.
Plankton, . . .	poor.

We find Chroococcaceae common, Dinobryon common during certain months, and plankton rich. The theory does not seem to hold good, and only expresses conditions seen perhaps in the lakes examined by Apstein.

Dinobryon is recorded for Greenland and Lapland often under the ice. It occurs in the alpine lakes, and is recorded by Kofoid for the Illinois River. Kofoid considers all the species as growth varieties of the one species.

#### Pediastrum.

The genus Pediastrum is represented in our plankton chiefly by the species *P. Boryanum*, *P. Boryanum* var. *longicorne*, and *P. duplex* var. *clathratum*, *P. duplex* var. *reticulatum* Lagerh. Pediastrum is a fairly frequent constituent of the plankton. It is absent only in December. The two species were studied separately, but the varieties were counted together.

*P. Boryanum* (Turp.) Menegh. has two maxima, one in April, when it reaches 37,200 in all the catches, and another slightly larger in August, numbering 39,000. In July it diminishes to 1500. After the August maximum it diminishes until December, when none were found in any of the catches. From February onwards it is present in fair quantities.

*P. duplex* Meyen (= *P. pertusum* Kütz) has a similar seasonal variation to *P. Boryanum*, but is usually somewhat less abundant. After the early maximum in April it diminished until the early part of July, when none were found at all. In August it reaches a higher maximum than *P. Boryanum*, viz., 45,500 in all the catches. Then it diminishes suddenly and is absent altogether in December and January.



Wesenberg Lund records both these species for the Danish lakes, but does not state in what quantities they occur or in what month they attain their maximum. Apstein records a double maximum for *Pediastrum* in the Baltic lakes, one in spring and a larger one in August.

It is absent from Ennerdale Water, Wastwater, Loch Lomond, Loch Katrine, Loch Earn, and Loch Lubnaig. West records the genus for the Scottish lakes, Orkneys and Shetlands, west and south-west Ireland, Welsh lakes, Lough Neagh and Lough Beg; but it is very uncommon.

*Pediastrum* is widely distributed in the arctic lakes; in the north European lakes it occurs, but only in small quantities, although the number of species may be large. Numerous species of *Pediastrum* have been recorded from the Baltic lakes, but they occur only in small numbers.

*P. Boryanum* occurs in the plankton of the Illinois River in small numbers during every month of the year. There are vernal and autumnal maxima in May and September at similar temperatures. *P. duplex* is much more abundant than *P. Boryanum* in the Illinois River; in fact, it is the most abundant representative of the Chlorophyceae in these waters. The seasonal variation is practically the same for both species.

#### Staurastrum.

Numerous species of this genus occur in the plankton of Lough Neagh, but by far the most frequent species is *S. paradoxum* var. *longipes*. For the purpose of this work all the species have been counted together.

It occurs throughout the year, but from the month of March until early in July it is present only in very small quantities. In September it reaches a maximum of 388,540 for all the catches.

Wesenberg Lund states that *S. gracile* and *S. paradoxum* var. *longipes* occur in the Danish lakes, the latter only rarely and the former in small quantities. *S. gracile* reaches its maximum in the summer months, viz., July and August. Apstein records *S. gracile* from the Baltic lakes, where it attains its maximum in August. It is at its minimum or absent altogether from March to June.

W. and G. S. West record several species of *Staurastrum* from Ennerdale Water, *S. jaculiferum* West forma *biradiata* being the most common. It reaches its maximum in August, and is rare in January and March. In Wastwater, *S. jaculiferum* West (f. *triradiata*) is very common from June to November, and rare from February to April. *Staurastrum* is present in small quantities in Loch Lomond, while in Lough Katrine it occurs in much larger quantities. Here West finds that *S. paradoxum* has its maximum from May to July, while *S. paradoxum* var. *longipes* has its maximum from August to

[H 2]

December. *Staurastrum* is also present in Loch Earn, but is absent from Loch Lubnaig.

In the Baltic lakes only a few species of *Staurastrum* occur, and they never attain great abundance. *S. paradoxum* is not recorded by Kofoid, but *S. gracile* was present in the waters of the Illinois in small numbers from March to January, with a maximum of 14,000 in September.

#### **Sphaerocystis.**

*Sphaerocystis Schroeteri* Chodat.—This species occurs in the plankton of Lough Neagh more frequently than any other member of the Palmellaceae or the Protococcaceae, although it is not very abundant. From November to February it is absent. In March it occurs in small quantities, and increases rapidly until in May it reaches a maximum of 121,000 colonies in the bottom-to-surface catch.

Messrs. West record *S. Schroeteri* from Ennerdale Water, where it reaches its maximum in June. It differs from the same species in Lough Neagh by being absent in August, but present in very small quantities during the winter months, whereas in Lough Neagh it is fairly abundant in that month, and absent in the winter months. In Wastwater it reaches its maximum in October and November, while in Loch Lomond it occurs most abundantly in July, August, September, and October. In Loch Katrine it is always very rare. The same is true of Loch Earn, while it is absent altogether from Loch Lubnaig.

Wesenberg Lund records *S. Schroeteri* from some of the Danish lakes. It appears in May, has its maximum in June, and disappears in August to September. Apstein does not record *S. Schroeteri* from the Baltic lakes.

It is one of the main forms of the Euchlorophyceae occurring in the arctic freshwater plankton. In the north European lakes *Sphaerocystis Schroeteri* is the most abundant of the Chlorophyceae. In the Baltic lakes *S. Schroeteri* is much less common; while in the central European alpine lakes it occurs in still smaller quantities.

#### **Dictyosphaerium.**

*D. pulchellum* Wood occurs in the plankton of Lough Neagh in very small quantities. Its maximum is probably in August–September, although it occurred in fair quantities in February. It was absent again from October to January and from May to July.

Messrs. West record it from Ennerdale Water, where it reaches its maximum in August and September. It also occurs fairly commonly in



March, and is absent in June and January. It appears to have a double maximum; but as it occurs in such small quantities, it is difficult to state this definitely. It is not recorded from Wastwater, Loch Katrine, or Loch Lubnaig. It is present in extremely small quantities in Loch Lomond in January and in Loch Earn in August.

Wesenberg Lund records *D. pulchellum* from the Danish lakes. In Lake Esromso it reached a great maximum in September.

*D. pulchellum* is typical of the North European lakes only.

#### **Eudorina.**

*Eudorina elegans* Ehrenb. occurs in the plankton of Lough Neagh in very small numbers from July to December. The numbers are at their highest from August to October, reaching 18,500 in all the catches combined. It disappears in January, and does not appear again until July.

Messrs. West do not record *Eudorina* from those lakes examined quantitatively by them. Apstein records *E. elegans* from the Plöner See, where it occurs from July to November, reaching its maximum in August. Wesenberg Lund observed *Eudorina* in all the Danish lakes examined by him. *Eudorina elegans* has been recorded from east and west Greenland and from Nova Zembla. It occurs also in the north European lakes and the Baltic lakes. It is fairly common in the central European alpine lakes.

This species is recorded from the Illinois River by Kofoid, where it occurs from February to October and in smaller numbers, and sporadically, during the colder months. The maximum occurred in April.

#### **Tribonema.**

*Tribonema bombycinum*, forma *depauperata* Weille, occurs in Lough Neagh in fairly large quantities, although it is never so abundant as *Oscillatoria* or *Melosira*. It is almost identical with *Oedogonium*, and has probably been mistaken for the latter. Messrs. West make no mention of *T. bombycinum*. Our species has been kindly determined by Lemmerman.

It is present in the plankton of Lough Neagh through the year, reaching its maximum in March (950,000 in the bottom-to-surface catch). During April and May it diminished to 100,000; and in August it rose again to 420,000. It is at its minimum during November, December, and January.

Messrs. West do not record *Tribonema bombycinum* from any of the British lakes examined by them, but *Oedogonium* sp. (sterile), with which it may have been confused, occurs in all these lakes very rarely.

In Loch Lomond *Oedogonium* is less rare in March, August, and in September, while in Loch Katrine it is fairly common in August, September,

November, and December. In Loch Lubnaig it is fairly common in October, but very rare in March. Thus the times of the maxima of *Oedogonium* in these lakes differ from each other and from *Tribonema* in Lough Neagh.

Wesenberg Lund records *T. bombycinum* forma *depauperata* from all the lakes examined by him in Denmark. It reached a very large maximum in June and July in Esromso.

No mention is made elsewhere of the occurrence of *Tribonema bombycinum* in the plankton, but this is probably due to its very close resemblance to *Oedogonium*.

## ZOOPLANKTON.

### ROTIFERA.

#### *Anurea*.

*Anurea cochlearis* var. *tecta* Gosse.—This is the most abundant rotifer in the plankton of Lough Neagh. It is present throughout the year, and reaches its maximum (142,500 in all catches) towards the end of July. The minimum occurs early in February, and the numbers remain low until late in May. Very much attention seems to have been given to this Rotifer, and hence its biology is now rather well known. Its temporal variation in form has been discussed elsewhere. Its length of life has been determined as about thirteen days at 18° C. It forms part of the food of *Abramis brama*.

Concerning distribution and times of of maxima in other lakes the following may be said. Wesenberg Lund records the species from lakes, ponds, and ditches in Denmark, and finds the maximum earlier than we, i.e. in May or June. In the Baltic lakes Apstein finds the species with a maximum at the same time as ours—at the end of July in the Plöner See, but earlier in the Dobersdorfer See. In the Scotch lakes *Anurea cochlearis* is of general occurrence, and sometimes is so numerous as to render the water turbid. *A. cochlearis* is a common feature of the arctic plankton, which is rich in Rotifers; and in short it well fills a place in that small community of species designated by Wesenberg Lund as cosmopolitan.

*Anurea aculeata* Ehr.—This species occurs in the plankton of Lough Neagh in small numbers only. It appears late in March, reaches its maximum in July, and disappears completely towards the end of September. Wesenberg Lund reports *A. aculeata* from most of the ponds and lakes of Denmark, where it appears to be perennial. It reaches its maximum between April and June. In the Baltic lakes, the Plöner See and Dobersdorfer See, this species reaches its maximum in June, and is only present for part of the year.

In the Scottish lakes Murray and Pullar state *Anurea aculeata* is only of rare occurrence, and then only in the smaller lakes. This species with *A. cochlearis* belongs to the cosmopolitan community of Wesenberg Lund.

Kofoid records the species from the waters of the Illinois River, where it appeared in March, 1898, and increased to a maximum in May. It then declined and disappeared in June. There were, however, scattered occurrences throughout the winter months, and in 1894 Kofoid records an autumnal pulse in September.

#### Polyarthra.

*Polyarthra platyptera* Ehr.—Occurs in Lough Neagh in fairly large numbers. Except for *A. cochlearis*, it is the most frequent of the Rotifers. It appears towards the end of May, and increases rapidly until it reaches its maximum in August and September (51,000 in the combined catches). It disappears completely in January, and is absent throughout the winter and spring months. Murray and Pullar record *P. platyptera* as general in the Scottish lochs and in the rest of Europe. Wesenberg Lund states that in the larger Danish lakes the species is dicyclic, the sexual period occurring during March and April being the most marked. This differs strikingly from the state of things found in Lough Neagh, as here *P. platyptera* is absent altogether from the plankton until late in May. In the ponds in Denmark the species is polycyclic. In the Baltic lakes Apstein records *P. platyptera* from the Dobersdorfer See, where it is present in all the months except March. It reaches its maximum in July to August. In the Plöner See it is present throughout the year, and reaches its maximum in May. *P. platyptera* is included in Wesenberg Lund's list of the cosmopolitan species of Rotifers. *P. platyptera* is recorded by Kofoid from the waters of the Illinois, where it is one of the most abundant of the Rotifera. It is perennial; but during the colder months, October–April, it occurs only in small numbers. It attains its maximum in April; but it is polycyclic and has monthly recurring pulses. In addition to the widespread distribution of *Polyarthra* indicated above, it may be added that the species has been sometimes found to occur in the brackish water of the Baltic.

#### Notholca.

*Notholca longispina* Kell. is another Rotifer of widespread distribution, and belongs to the cosmopolitan plankton community of Wesenberg Lund. The long spines present in this species are probably, like many other long processes developed in active plankton organisms, for giving stability in movement—orientating organs—and not organs for buoyancy.

The species occurs in the plankton of Lough Neagh in small numbers; but it seems to be present throughout the year. It is not recorded for November

or January ; but as it was present in December, it is likely that the numbers were too small to be represented in the counts. The maximum was reached in June (9,000 in all catches). Other periods of maxima have been recorded between May and August ; and in some places—North American lakes—it develops exceptionally in winter. In other lakes it appears to have two maxima, as in the Achen See, where there is a spring maximum in March and April, and a chief maximum in August.

Wesenberg Lund records the species for all the lakes investigated in Denmark. It was present throughout the year, and reached its maximum between May and August. Apstein records the species from one of the Baltic lakes—Plöner See—where it reaches its maximum in August, and is absent during November, December, and January. It seems to be more common in Scotland than with us ; for Murray and Pullar record the collections of plankton as sometimes brick-red in colour, through *Notholca longispina*. Kofoid notes *N. longispina* only once in the plankton of the Illinois River, January, 1895.

#### **Triarthra.**

*Triarthra longiseta* Ehr.—Occurs in Lough Neagh in fair quantities, being, after *Anurea cochlearis* and *Polyarthra platyptera*, the next important Rotifer in frequency. It appears about the end of March, and increases slowly in numbers at first, attaining its maximum in July (39,000 in all the catches). After this the numbers drop away suddenly, and in November it disappears completely.

Wesenberg Lund records the species from all the lakes investigated in Denmark, where it is perennial, the sexual period occurring in May. Apstein does not record *T. longiseta* from the Dobersdorfer See ; but in the Plöner See it is present. The maximum occurs there in August. In the Scottish lochs, Murray states that *T. longiseta* is comparatively rare, and is locally distributed. The species is cosmopolitan. Kofoid records *T. longiseta* from the Illinois River, where it occurs throughout the year. Their numbers are more frequent from May to October, and the maximum is reached in September.

#### **Notholca.**

*Notholca striata* Ehr.—A less common constituent of the plankton of Lough Neagh. It is absent from the end of April to September. In October and the following months it occurs in small numbers, and it reaches its maximum in February and March (22,000 in the combined catches).

Wesenberg Lund records *N. striata* from most of the lakes of Denmark, where it attains its maximum in the period December to April. It was never observed in summer. Apstein records *N. striata* from the Plöner See in

north Germany during the months of February, March, and April, when it occurred in very small numbers. Murray records *N. striata* as a pond species, rare at the margins of lakes in Scotland. *N. striata* is recorded by Kofoid in the Illinois River. It is a winter plankton, appearing in November, and attaining its maximum in March and disappearing in April.

Thus it will be seen that in Lough Neagh, Denmark, the Baltic lakes, and America the species occurs in the same period of the year—a striking example of the uniformity of fresh-water species with cosmopolitan distribution.

#### **Mastigocerca.**

*Mastigocerca capucina* Zach. and Wierz.—Appeared in the plankton of Lough Neagh in extremely large numbers in August and September. It was not observed at any other time.

Wesenberg Lund records it from the lakes of Denmark, where it occurs from May to October–November. In Furesø it was observed on January 31st. Apstein records it from Dobersdorfer See, where it appears in June, attains its maximum in August, and disappears in November. In the Plöner See it occurred in July, 1893. In 1892 it reached its maximum in the latter part of September, and was absent in November.

Murray does not record it from the Scottish lakes.

It is absent from the arctic region, and occurs as a summer form in the north European, Baltic, and the Swiss lakes. Amongst other Rotifers occurring were:—

*Metopidia lepadella* Ehrenbg.

*M. oscipternum* Gosse.

*Synchaeta pectinata* Ehrenbg. (specimens fully contracted).

#### **COPEPODA.**

*Cyclops strenuus* Fischer.—Occurs in the plankton of Lough Neagh in large numbers. It is present throughout the year. In July there is a maximum of 3,425 in the combined catches, after which there is a descent to 1,600 in September. The number then rises rapidly until it reaches 4,722 in October, after which the numbers remain high until February.

Wesenberg Lund has obtained a similar seasonal variation for *C. strenuus* in the Danish lakes, although the first maximum there occurs in spring. Apstein does not record *C. strenuus* from the Baltic lakes; but it is probably present, and recorded in later works. Murray records it as general in the Scottish lakes, where it occurs all the year round. *C. strenuus* occurs in the plankton of the arctic regions, where it is one of the main forms of the large

lakes. It is also the most important species of Cyclops in the north European region. In the Baltic lakes, *C. strenuus* is common; but the chief form is *C. oithonoides*, while *C. strenuus* is here mainly a winter and deep-water form. *C. strenuus* is also the commonest form occurring in the Alpine lakes, more especially in the high ones.

This species of Cyclops far outnumbers all others occurring in Lough Neagh. In fact, the other species are somewhat rare, *Cyclops viridis* being present in small numbers. It gives, as will be referred to in another part of the paper, an arctic feature to the plankton of the lake.

*Diaptomus gracilis* Sars.—Is the most abundant Copepod in the plankton of Lough Neagh. It is present throughout the year, and, like *Cyclops strenuus*, has two maxima, one in May (4,903 in all the catches), and one in October (5,336 in all the catches). The numbers remain high until February.

Wesenberg Lund finds this species in several of the Danish lakes; but there is no strongly marked sexual period. Females with eggs are, however, most frequent in May; and in September to October there is another sexual period which is even less marked than in spring. Murray records *D. gracilis* as general in Scotland, where it is perennial in some of the lochs. In certain lochs at high elevations it has a seasonal limitation. It is the commonest species in Scotland, as in Europe generally. *D. gracilis* is one of the main forms of the large lakes in the arctic district designated by Wesenberg Lund. It is also the chief form of the north European lakes, the Baltic lakes, and the central European alpine lakes. The distribution of the genus *Diaptomus* has been worked out recently in very great detail. A further reference to this will be found on page 77.

## CLADOCERA.

### *Daphnia hyalina* Leydig.

*D. hyalina* var. *lacustris* occurs in Lough Neagh in large quantities during certain months of the year. It appears for the first time in April, and increases slowly at first. In June it suddenly reaches its maximum (6690 in all the catches). It then decreases slowly, and disappears completely in January.

Wesenberg Lund finds this variety, which he terms subspecies, in Viborgso and Haldso only. In Viborgso, it has a great maximum during the summer and a second great maximum towards winter, after which it disappears completely. In Haldso, the species has a great maximum in the early summer and a smaller maximum towards winter, throughout which it is present.



Murray finds that *D. hyalina* is general in Scotland, where it may be perennial. In some of the higher lochs it dies out in the winter. Kofoid records *D. hyalina* from the plankton of the Illinois River. The individuals appeared in spring and attained their maximum in June, and disappeared in July. Apstein finds that *D. hyalina* occurs in the plankton of the Baltic lakes from September to July, attaining its maximum in November to January.

The period of reproduction differs very considerably in different districts. In the arctic regions it is monocyclic, while in the low-lying Swiss lakes it is acyclic. It has been known to reach its maximum in spring, in winter, or in both, and may be perennial or present in the plankton during a few months of the year only. The species is common all over Europe, the arctic and the tropical zones. In the Baltic lakes it is less common than in the arctic lakes, and occurs more frequently as a pond form than in the pelagic region of the large lakes. In L. Neagh at the time of its maximum it is the most common crustacean in the plankton.

#### **Bosmina.**

*Bosmina* is one of the plankton forms that has been most studied from the point of view of seasonal variation. More interesting still, however, is the study of the distribution. The species of *Bosmina* that are common seem to be very definitely distributed, so much so, in fact, that definite regions in Europe can be mapped out by the presence or absence of certain forms.

In L. Neagh *Bosmina* appears to be our most abundant Cladoceran caught in the net-catches. The records for these forms in Ireland seem to be very thin; and in Lough Neagh the form recorded by Kane is *Bosmina mixta* (stated by him to be not previously known from the British Isles). This species is certainly one of the lesser characteristic forms; and it renders it all the more curious that Kane has not recorded *Bosmina obtusirostris* from Lough Neagh—a form which is somewhat closely approached by *B. mixta*. We have found two species in large numbers, viz. *Bosmina obtusirostris* and *Bosmina longirostris*. This, of course, does not preclude the existence of other species in small numbers. As mentioned before, the work has not been of a detailed systematic kind.

We have discussed in another part the remarkable character—*Bosmina obtusirostris* and *B. longirostris* occurring together in considerable numbers and their relations from the point of view of distribution. In the table the two species have been lumped for convenience in counting. In Scotland the most common species appears to be the arctic form *B. obtusirostris*. In Lough Neagh *B. longirostris* appears to occur in the greatest numbers, although both

[1 2]



are very common. *Bosmina* was present in the first catch taken, February 23rd, 1910; and the number steadily increased until the maximum was reached on May 11th. - From that date the numbers fell until September 8th, after which no others were recorded. The maximum occurs, therefore, in late spring.

Wesenberg Lund records the maximum for *B. longirostris* in the Danish lakes in May and the beginning of June, agreeing with ours. He states also that its disappearance from the pelagic region after the maximum is marked by the presence in the littoral regions. Kofoid records *B. longirostris* from the Illinois River. It is perennial with a maximum at the end of May or beginning of June and an abrupt descent after the maximum. The numbers from October to May are very small. It is very striking that in two places so far removed and so dissimilar as Kofoid's region and Lough Neagh such similar sequences should be observed. The maxima seem to occur at the same time: we have the abrupt descent, and none are present at all from September onwards. *B. longirostris* occurs generally in American waters.

#### TEMPORAL VARIATION IN PLANKTON ORGANISMS.

Perhaps one of the most interesting and important sides of fresh-water plankton studies has been the discovery and investigation of the changes taking place in the form of plankton organisms during the seasons. These changes in form have been seized by systematists, who have made countless new species and varieties on the variations presented to them.

During the last fourteen years or so, however, many workers, especially those investigating the plankton throughout long periods, have supported the view that the variations in shape and size could not be used as indicating new species, but were simply changes in one species produced by alterations in the environment. This view has been proved correct in many cases by taking up one organism and following its changes in the same water-area throughout a year. One then finds a great series of steps linking up perhaps two such different forms that might well have been termed different species. No study of this side of the plankton can be taken up without causing one to feel the utter absurdity of making new species among the Protozoa and Protophyta from one single individual as has often been done. Even when a group of like individuals is found, they may be bearing merely a local and temporal change in form which does not breed true. One of the results of this work, pointed out by Wesenberg Lund, is that G. O. Sars, who founded numerous species of plankton Cladocera, has gone back to such an extent that probably more than fifty of the old species and subspecies of planktonic *Daphnias* are now referred to a single species.

Wesenberg Lund has been foremost in the discussion and investigation of the temporal variation ; and we take from him the classes of form-variations that may be recognized. There are four different kinds—individual variations, age variations, local variations, and seasonal variations.

Little is known of the two first ; but the latter kinds have now been investigated by a large and ever-increasing number of continental workers, most of whom have associated themselves with some group or genus. Moreover, it is the local and temporal variation which has been responsible for the creation of new species.

Seasonal variation has been studied by Lauterborn in a quite famous case of the Rotifer *Anurea cochlearis*. Langhans has treated other species of zooplankton. Wesenberg Lund himself has directed attention to the Diatoms as well as to most of the other groups of plankton organisms.

Temporal variation has, in fact, been so far discussed in connexion with the following species :—

ZOOPLANKTON CLADOCERA.	Hyalodaphnia.
	Daphnia (various species).
	Ceriodaphnia.
	Bosmina longirostris.
	Acroperus.
	Evadne.
	Podon.
COPEPODA.	Cyclops strenuus.
	Diaptomus gracilis.
ROTIFERA.	Anurea cochlearis.
	„ aculeata.
	Asplanchna.
	Triarthra longiseta.
	Notholca.
	Polyarthra.
	And others.
DINOFLLAGELLATES.	Ceratium hirundinella.
FLAGELLATA.	Dinobryon.
PHYTOPLANKTON DIATOMACEAE.	Fragilaria crotonensis.
	Asterionella.
	Tabellaria.
	Cyclotella.
	Stephanodiscus.
	Melosira.

The variations observed in the above cases affect the size, shape, and presence or absence of longer or shorter spines. It would be quite impossible here to refer to the extensive literature on the subject. Reference should be made to Wesenberg Lund (1) and to numerous papers in the *Revue Internationale de Hydrobiologie* during the last few years. There is very much work to be carried out yet on this subject; but it is necessary that observers make a special study of some particular group.

The cause of these temporal variations has been ably discussed by Wesenberg Lund; and it is to this worker that we owe the first attempts to explain the variations by a common phenomenon. Wesenberg Lund's view was that the organisms reacted to an external stimulus, and that this stimulus was a change in the specific gravity of the water caused by changes in temperature. Form-variation was therefore an effort to bring the specific gravity of the organism into equilibrium with the altered specific gravity of the water at certain times of the year. It was observed that seasonal variations were not commonly found in arctic, alpine, and other lakes where great annual fluctuations of temperature did not occur. The relation of Lough Neagh to the Scottish lochs is an example of this, and will be referred to again below.

Numerous workers have noticed that the size of many plankton organisms becomes smaller as the summer approaches. Wesenberg Lund's view was modified and accepted more readily after the work of Ostwald. Ostwald showed that the changes in specific gravity of the water were very small, owing to the small ranges in temperature, but that this temperature-variation strongly affected the viscosity of the water, the property possessed by a liquid of resisting movement through it, or, in short, the friction.

The power of flotation possessed by a plankton organism depends upon its specific gravity. If an organism is heavier than water, bulk for bulk, it will sink. The speed of sinking depends upon the area of the surface in contact with the liquid relatively to the volume of the object, and upon the shape of the sinking body. A third factor, however, stands in important relationship to the specific gravity and shape, namely, the viscosity of the water. We may experiment with the same object in two fluids having the same specific gravity—for example, alcohol and melted wax. It will be seen clearly that the speed of sinking depends on the nature of the liquid—on its viscosity. Temperature affects the viscosity; for example, the speed of sinking is twice as fast at 25° as it is at 0°. The addition of salt in solution in water decreases the speed of sinking. These physical questions throw very considerable light on the factors governing the biology of plankton organisms; and we might infer that the decrease in size of an organism in the summer

is for the purpose of increasing the superficial area relatively to the volume, and hence increasing the *resistance* due to the viscosity of the water.

As Wesenberg Lund has since pointed out, Ostwald's theory had been put forward before that time by two other workers, O. Müller and Krogh. Krogh, however, believes that changes in the viscosity are not the main cause of seasonal variations, and takes up the view that seasonal variations are occasioned by varying condition of nutriment. He has been supported by Langhans, Steuer, and more recently by Woltereck and his pupils, who have experimented in great detail on Cladocera and Rotifers. Woltereck's work in particular has thrown great light on the biology of the Daphnids.

It seems to us that the satisfaction with which the theory of viscosity and the relation of form to changes in viscosity has been received is tending to keep back experiments on the subject. The occurrence of form-changes, which go hand in hand with temperature-changes, and the delightfully simple way of correlating the two by considering the changes in form as adaptations called forth by alterations in viscosity, may be nothing more than building up a structure on a mere coincidence. We do not want to deny absolutely the theory of Wesenberg Lund-Ostwald, but we wish to show how the whole theory must be considered as not proven and the necessity for further observation.

In the first place, it is difficult to see how changes in viscosity could call forth a different shape or size as an adaptation. Natural selection can hardly avail, because we are dealing with one species, the individuals of which are affected separately and temporarily. The change in form simply means that any individual may be modified by the external medium, and may itself give rise to forms which may or may not be like the parent according to the conditions under which they live. Are we to conclude, then, that this change in form which is caused by some change in the external medium is an adaptation because it fits in with a theory, or that it is a response to some stimulus the result of which happens to have fitted in with a theory of flotation, only as a coincidence? For example, most of the pelagic eggs of fish have been found to have a greater diameter as the water became less dense. For instance, the eggs of the Flounder from the Baltic (in salt water) had a diameter of 1.054 to 1.216 mm., whilst in the more saline water of the North Sea the eggs of the same species possess a diameter of 0.915 and 0.970. The specific gravity of these eggs is nicely adjusted to that of the water, and yet the figures above are in striking contrast to what should be expected on the Wesenberg Lund-Ostwald hypothesis. We should expect smaller eggs—eggs with a greater superficial area to the volume—in the less viscous water. The opposite is the case.

Again, in the sea it is characteristic to find organisms of greater size in the arctic seas than in the tropics, *whether pelagic or not* (Molluscs, Crustacea, Ascidia, etc.). That is to say, the difference in size and shape is a direct result of some external force, which may or may not happen to be of slight advantage from the point of view of flotation.

Now let us look more closely at the supposed advantage. The workers who have taken up these theories seem to have considered the organisms as dead shells. As far as we know, in floating organisms the protoplasmic part which is of the greatest importance in flotation or buoyancy is directly affected by the constitution of the external medium. The specific gravity of Plaiice eggs depends directly upon the specific gravity of the external medium. At the same time it has been shown by Ostwald that changes in the specific gravity of fresh water caused by temperature-variations are but slight. Surely, then, planktonic organisms which are actually lighter than water will remain lighter than water whatever be the changes due to the small variations in our lakes. Moreover, no experiments have ever shown that organisms whose specific gravity is less than that of water in spring would sink in the water of summer. Thus it seems to us that all organisms which float without active movement must be ruled out altogether from the resistance and viscosity theory. Let us look now at the organisms which sink in water and are yet pelagic. They are found at the surface because of active movements. Now suppose that one of these organisms sinks 2 centimetres in  $x$  seconds in cold water; the animal by active motion must lift itself 2 centimetres against the resistance of the water if it is to remain floating. Suppose that this organism gave rise to others which retain the same size and shape in summer. On the Wesenberg Lund-Ostwald theory, which is quite correct so far as this point is concerned, the animal would sink more than 2 centimetres in  $x$  seconds because the resistance of the water was less. At the same time this might *not* be disadvantageous so far as floating was concerned, because the animal could keep itself up with *less energy* for the same reason—the reduced viscosity of the water.

Against all this theory we have the actual experiments of Woltereck, Sachse, Diffenbach, and others, which show that given a constant temperature, different-sized organisms can be produced by differences in nutrition. We know that temperature of the water can affect shape. Wesenberg Lund's discovery and that of most observers, including ourselves, show that many fresh-water organisms are reduced in size in the summer months, and furthermore that the changes are most marked where temperature-variations are greatest. This, however, simply means that growth is greater in the colder water, and we must not jump to the conclusion that the smaller size in

summer is another wonderful case of adaptation. How many times have neat theories been propounded to account for some features in animals which are probably no advantage to them whatever, but are allowed to remain by natural selection because they are bound up with some character of great importance? We have actual experiments to show that nutrition affects size. In the case of Crustacea, the constitution of the external medium affects the size (Woltereck is at present working at this subject). Temperature-changes affect size and form. In short, we may say that numerous temporal variations may be called forth by just as diverse changes in environment, environment being taken in its widest sense to include all external factors affecting organisms.

The investigations of the Scottish fresh-water lochs already referred to have thrown practically no light on form-variation; for, in the only lochs examined throughout the year, such changes are stated to have been exceedingly small. The lochs, however, where these observations were carried out are, according to James Murray, amongst the largest, while the annual range of temperature-variation is low. Yet the statement is made that, in the different lochs, all the different forms of *Asplanchna*, *Daphnia*, *Bosmina*, etc., occur. Referring to *Ceratium hirundinella* we find, from Hewitt's paper, that variations occur with temperature which do not agree with those observed in continental lakes nor in Lough Neagh, and which are in opposition also to the viscosity theory. All this tends to support our view that the conditions and factors governing form-variation are not so simple as is generally supposed.

So far as Lough Neagh is concerned, we have not done more than examine some few species to determine whether form-variation occurs; and it is probable that another paper will have to be published as a separate study in this connexion. On the whole, we find the normal variation similar to that recorded in Danish and continental lakes.

#### ***Fragilaria crotonensis.***

In this species we find, as did Wesenberg Lund, great variation in size. Moreover, these variations in size are present at one and the same time. Taking as a matter of fact any one of our catches, there is just as great variation in the size as in a year's observations of averages. We have not dealt with very large numbers; but our figures indicate that, in all probability, three forms occur so far as size is concerned. It is practically impossible to say, therefore, from our figures whether any seasonal change in size takes place.



**Tabellaria fenestrata.**

In the Danish lakes this appears in stellate form in the summer months June, July, and in chains for the greater part of the year. Schroeter also found stars in summer, but chains in winter. In Lough Neagh *Tabellaria fenestrata* is common all the year round, and is always found in stars. A few zigzag chains may sometimes be found in the cooler months; but they are rare and often end in a star. We have made tables illustrating the number of cells in the colonies, and find rather an interesting variation. Taking the average number of individuals in a colony from several counts, we have the following table:—

*Average Number of Individuals in the Colonies of Tabellaria.*

1911—Feb. 23, 4·85;    March, 3·8;    April, 3;    May, 5·7;    June, 5·3;  
           July,    5·5;    Aug.,    6·6;    Sept., 4·3;    Oct., 7·2;    Nov., 8·1;  
           Dec.,    8·3. 1912—Jan., 7·6;    Feb., 6·1.

The maximum occurs between June and September. The largest number of individuals in colonies occurs *just after* this maximum. The smallest number of individuals in colonies occurs in March and April *just after* the minimal catches were made.

The variation in size is extremely slight, as the following figures show:—

1911—Feb. 23, ·336;    March 5, ·337;    April 13, ·326;    May, ·338;  
           June,    ·338;    July,    ·348;    Aug.,    ·328;    Sept., ·333;  
           Oct.,    ·322;    Nov.,    ·306;    Dec.,    ·306.  
 1912—Jan.,    ·31;    Feb. 3,    ·307.

These figures show that the smallest occur in the winter and when the largest number of individuals are found in the colonies.

**Asterionella gracillima.**

In the case of *Asterionella* we have also tabulated the number of individuals in stars or colonies.

The variation is as follows:—

1911—Feb. 23, 5·45;    Mar., 3·3;    April, 4·4;    May, 5·7;    June, 5·6;  
           July,    4·6;    Aug., 5·4;    Sept., 5·8;    Oct., 8·0;    Nov., 6·7;  
           Dec.,    6·3.            1912—Jan., 7·05;    Feb., 5·9.

Thus in both *Tabellaria* and *Asterionella*, for some reason, the largest colonies occur in the months October to January. Another similarity is that this maximum number of individuals in colonies occurs in both forms after the great maximum of colonies in the plankton. The smallest numbers in the



colonies occur in March and April, and that is just after the minimum. Wesenberg Lund considers that the star-formation from the chain is an adaptation from a littoral to a pelagic life. This may be the case; but from the above figures it would hardly appear that it is the buoyancy that determines the change; for we should then expect stars when the water reached the highest temperature.

The size of the cells of *Asterionella* varies a little more than in the case of *Tabellaria*. They are as follows:—

1911—Feb. 23, ·318;	Mar., ·377;	April, ·361;	May, ·39;	June, ·35;
July, ·398;	Aug., ·374;	Sept., ·34;	Oct., ·342;	Nov., ·337
Dec., ·323.	1912—Jan., ·309;	Feb., ·318.		

The smallest individuals occur in the period December to February, that is just below the minimum, with low numbers present, and the largest occur irregularly between March and August, when the quantity present is great. As a matter of fact, the largest cells measured occur in July and May, when the number present was very great.

Thus, though there is a slight difference between *Asterionella* and *Tabellaria*, there is a general agreement in that the largest cells occur in the summer months—a fact in complete opposition to the buoyancy theory of Wesenberg Lund-Ostwald. Moreover, the large size seems to be correlated with the large number present in the plankton and with small colonies.

#### ***Ceratium hirundinella.***

Many observers have studied variation in *Ceratium hirundinella*, and their original papers must suffice for a detailed study of this form. A few observations have been made by us to determine whether variation takes place in the Lough Neagh waters.

*C. hirundinella* occurs as usual in Lough Neagh in two forms, the three-horned and the four-horned. The three-horned form has been stated by most workers to be the commonest and to be the predominant form under arctic conditions. The four-horned forms are supposed to occur chiefly in the summer months. These facts have been recorded for German and Swiss lakes. Some authors have stated that both forms are equally frequent at all seasons. The variations recorded by Wesenberg Lund seem to indicate that the size increases from May to June, then decreases during July–August, and then remains constant.

Krause has made the most detailed observations on variation in *C. hirundinella*. This author agrees with the work of Ostwald, and describes

[K 2]

the Ceratium as varying so that, while all sizes may be met with at the same time in the same waters, the number of the large forms steadily increases from June to September. He also states that both three- and four-horned forms may be found together in the same lake. We should not like to draw any definite conclusions as to the cause of the variations from Krause's results. We do not agree that viscosity is the sole factor or even the most important one in causing temporal variation in Ceratium.

So far as our figures go, the size-variations are as follows :—

	Apical.	Antapic (longest).	Total length.
Jan., Feb., Mar.	Practically absent from plankton.		
April 13, . . .	·625	·345	1·335
May, . . . . .	·560	·33	1·196
June, . . . . .	·540	·32	1·137
July 13, . . . .	·463	·25	1·097
August 18, . . .	·375	·233	·925
Sept. 8, . . . .	·45	·245	1·03
Oct. 21, . . . .	·415	·25	·98

So far as we can determine the variation is not of great importance. There is, however, no doubt whatever that the Ceratium are *largest* when they first appear, and there is a very steady and most marked reduction in size as the water increases in temperature. There is practically no increase in size as the temperature falls in autumn. It looks as if the change in size was not exactly due to viscosity changes. Thus we see in Lough Neagh the same seasonal variations present, which agree in most respects with those discovered by Wesenberg Lund. In the late summer months almost all the Ceratium are of the four-horned variety. This fits in with the viscosity theory; but it may be due to other factors, as we have suggested above. In May most individuals possessed three horns, and in June the fourth horn was present, but very small.

#### ROTIFERA.

Perhaps the most classic example of temporal variation is that of *Anurea cochlearis*, so well worked out by Lauterborn. Lauterborn arranged the variations observed into series which all follow on from certain original "subspecies." The size of the animal is in inverse proportion to the height of the water-temperature, and the winter forms are characterized by long posterior spines.

A curious discrepancy appears in the literature. Lauterborn, whose researches are stated by Wesenberg Lund to have been generally accepted,

states that the long spine is characteristic of winter forms, and is reduced or disappears in the summer. Wesenberg Lund states, on the other hand, that the posterior spine is longer in summer than in winter. It is also stated by Wesenberg Lund that seasonal variation is not so well marked, or is lacking altogether in arctic-alpine lakes and in the pelagic regions of larger lakes.

We have ourselves found that seasonal variation is very definite in its course. The tecta series is most abundant at all times; but we have seldom found individuals with no posterior spine, though it may be slightly reduced in length.

*Anurea cochlearis* (total length).

1911—Feb. 28,	1·215;	March,	1·22;	April,	1·33;	May,	1·275;
June,	1·258;	July,	1·285;	August,	1·033;	Sept.,	·988;
Oct.,	1·02;	Nov.,	1·048;	Dec.,	1·075.		
1912—Jan.	1·11;	Feb.	1·148.				

The series of averages given above are very remarkable indeed, in the fact that the curve for length is extremely irregular. There can be no shadow of doubt from the above figures that the size of *Anurea* varies in an extremely irregular manner. Moreover, there is a decrease in size with rise in temperature after April, and after September an increase in size with fall of temperature. This is in perfect agreement with the Wesenberg Lund-Ostwald theory; but there is no reason why the increase in size should continue regularly until the month of April. As a matter of fact, the *Anurea* agree better with the Ostwald viscosity theory than any other species of zoo- or phytoplankton; and yet it is in the Rotifera that experiments have shown other factors are determinants, because they happen to run a parallel course to form-variation. The temperature factor might act in other and more direct ways.

The only spineless form found occurred in September, when the smallest individuals were observed. On the Ostwald hypothesis we should have expected small individuals *with long spines* in the summer months. This reduction in size of the spine agrees with Lauterborn's own researches, and gives no explanation of Wesenberg Lund's statement that the spines were longer in summer forms.

So far as the Crustacea are concerned, we have had no time as yet to make detailed series of measurements, though from the observation of catches we know that the definite changes in the shape of the head take place.

GENERAL OBSERVATIONS ON THE PLANKTON OF  
LOUGH NEAGH.

A general observation of any charts showing the distribution of aquatic organisms will at once show that there are far more species present in the sea than in fresh water. Some groups of animals like the Echinodermata, Coelenterata, Porifera, Brachiopoda, and Tunicata are practically entirely marine. Other groups are represented by a vast majority of marine forms. A few groups of animals are characteristic of fresh water. Until the Lough Neagh research was taken up, the authors had studied almost entirely the marine plankton. The distribution and variation of marine forms had been observed at Kiel, Heligoland, Naples, and the Irish Sea. This familiarity with the marine plankton has enabled us, perhaps, to note with particular interest many small characters of the fresh-water plankton of Lough Neagh that would have been passed by perhaps without much notice by the fresh-water planktologist. We do not say that he would have missed them, or even under-estimated them. Many features, however, will undoubtedly have been seen by us from a different point of view; and, as a matter of fact, it is rare in literature to find a discussion of fresh-water plankton by the marine planktologist.

The first point that aroused our attention in Lough Neagh was the quantity of plankton present in the water. The quantity of plankton present in the Lough Neagh water is by no means characteristic of fresh water; but, unfortunately, no quantitative measurements have been made by using a similar net under similar conditions in different lake-areas and in the sea. We have, however, used our net in the Irish Sea at all seasons of the year, and throughout a year in Lough Neagh. As before mentioned, so great is the quantity that the water of Lough Neagh is coloured by the plankton.

The hauls of a Nansen net off the Isle of Man are given by Herdman, Scott, and Dakin in their Irish Sea work of 1909.

The following table shows the volume of plankton in the catches; and it must be remembered that the net has been hauled through *three times* the depth of our Lough Neagh catches.

IRISH SEA PLANKTON, 1909.

*Nansen Net Hauls.*

March, 0·2–0·7 cc.;	April, 0·7–18·7 cc. (average about 4·0 cc.);
May, 14 cc.–2·5 cc.;	June, 5·5–1·5 cc.;
August, 0·1–1·0 (average about 0·4 cc.).	

1910.

April Catches (time of max.).	August Catches.	September.
3·0 11·5 6·0	1·5 1·5 11·5 3·0	0·5 0·9
3·7 7·5 8·7	1·5 5·2 5·7 4·0	1·8 1·5
2·0 8·2 3·6	0·9 6·5 4·2 1·0	1·7
2·7 8·5 2·7	2·5 2·5 5·8 2·0	3·0 etc.
	2·3 3·8 6·6 1·3	2·6
	3·5 0·8	
	1·3	

The average Nansen catch in *three times the volume of water* in the Irish Sea is about 0·5 cc., except in late April and May, when the spring maximum occurs, and later on in September when another, but smaller, maximum occurs. During these times the average catch is about 6·0 cc. We have seen, however, this catch jump suddenly in volume to 40 cc. Every year there is a most marked increase in volume in the spring.

Now the volumes of the plankton caught in Lough Neagh are remarkably uniform. For example, in 1910 the bottom-to-surface hauls (only 40 feet) gave:—

Feb., 13 cc.;	March 5, 12·0;	March 16, 9·0;	April 13, 12·5;
April 7, 10·0;	May 11, 12·0;	May 25, 9·0;	June 10, 17·0;
July 13, 8·5;	July 27, 4·0;	August 18, 13·0;	Sept. 8, 3·5;
Sept. 29, 7·5.			

Thus there is no doubt that for the greater part of the year there is far more plankton in the Lough Neagh water than there is in the Irish Sea. Moreover, whilst the different organisms are appearing and disappearing in Lough Neagh, and passing through their maxima, the total volumes of the plankton are not disturbed to any great extent. It is very doubtful if the great spring maximum found usually in the Irish Sea is enough to bring the marine figures near to the figures for the fresh-water plankton of Lough Neagh.

Now the appearance of the Lough Neagh plankton suggests, before any microscopic observations are made, that the phytoplankton almost always far exceeds the zooplankton in quantity. The zooplankton is most abundant at the beginning of the summer and through the summer months.

In our marine catches of plankton the catch might be predominantly phytoplankton; it might be entirely composed of zooplankton; or it might even be composed entirely of one species. On the whole, the number of species, however, was much greater than in the fresh-water catches from

Lough Neagh. For example, the number of species each present in large quantity may be taken as about fifty. Against this the number of species that could be easily counted in our fresh-water catches was only about thirty-five. This feature was very striking. Most of our catches under the microscope consisted of enormous quantities of a few species. This rendered the enumeration of some of the more rare organisms quite impossible. If the catch was diluted enough to thin out the individuals, none of the rare species would be perhaps on a counting-plate. If, on the other hand, the dilution was arranged to bring a considerable number of the rarer species on the plate, they were completely obscured by thousands of individuals of perhaps one or two species. These two differences, 1st, the quantity, and 2nd, the constitution, were perhaps the most marked ones observed.

The constitution of the marine phytoplankton is almost entirely of species of Diatomaceae and Peridineae. In the composition of the Lough Neagh phytoplankton the Diatoms, Desmids, and Myxophyceae play a great part. The Peridineae are represented by *Ceratium hirundinella*, which often occurs in great quantities, and Peridinium. The Myxophyceae, which are amongst the most conspicuous forms in the Lough Neagh plankton, are represented by *Oscillatoria*, *Gomphosphaeria*, *Anabaena*, as well as some other less frequent species.

From the observations on phytoplankton of other fresh-water lake-areas, we notice that the arctic plankton is characterized by the absence of the Myxophyceae, the presence of large quantities of *Tabellaria*, *Melosira*, *Asterionella*, and the presence of *Fragillaria*, *Stephanodiscus*, etc.; a few Dinoflagellates also occur, and species of Dinobryon.

The central European lakes and especially the Baltic lakes, the best known so far as their plankton is concerned, are characterized by the abundance of Myxophyceae and by *Fragillaria crotonensis*, *Asterionella* and *Melosira* amongst the diatoms. *Tabellaria* is somewhat rare.

Our phytoplankton is characterized by the presence, first and foremost, of *Tabellaria fenestrata*, which is present all the year round, and attains 34,000,000 colonies in one catch; then

- Oscillatoria Aghardhii* (Gomont).
- Gomphosphaeria Naegeliana* (Unger) Lemm.
- Anabaena flos-aquae* (Lyng.) Brét.
- Melosira* sp.
- Asterionella*.
- Fragillaria crotonensis*.
- Ceratium*.

Thus the phytoplankton of Lough Neagh contains in great abundance the

characteristic forms of the arctic and also the central European plain plankton. Thus, so far as the phytoplankton is concerned, we have a most interesting mixed flora.

While Lough Neagh agrees with the Danish lakes in the relative abundance of the phytoplankton, the characteristic species present in both areas are different. Many of our species are also found in large quantities in the Danish lakes, but on the whole there is a considerable difference. Thus *Tabellaria* does not play such a striking part, nor do apparently the Myxophyceae, except at certain seasons.

The Scottish lochs seem to be relatively poor in the Myxophyceae. *Melosira* is rather rare. *Stephanodiscus astraea* never occurs commonly as a plankton organism, and *Fragillaria crotonensis* is rather rare. On the other hand, as Messrs. West have shown, the Scottish lakes are characterized above everything by an extraordinary abundance of Desmids. So far as Lough Neagh is concerned, the only Desmid occurring in very large quantity is *Staurastrum*. This occurs in great quantities in September (158,000 in one catch), but is far behind the numbers of other Chlorophyceae.

Lough Neagh is by no means a "Desmid lake." Messrs. West have propounded a theory to account for the prevalence of Desmids in certain of the British Lake areas. Wesenberg Lund and James Murray have also discussed the problem. So far as our observations of the district go, the facts entirely support Messrs. West. These workers have noticed that the rich Desmid lakes occur in areas belonging to the older geological formations. Wesenberg Lund has stated that Desmids thrive best in water rich in humic acids from peat bogs, and James Murray has also objected to the theory; but there seems little doubt at present that Messrs. West's theory agrees best with the facts observed.

Practically all the water of Lough Neagh is from drainage areas of more recent than Jurassic times; and we have already seen that Lough Neagh is not a Desmid lake. No doubt a drainage water derived from bogs and peat-beds in general is of considerable importance; and it is very probable that other factors besides the geological formation are determinants, yet the coincidence of Desmid areas with old-formation lakes is most marked.

The phytoplankton of Lough Neagh is practically at all times in excess of the zooplankton, and to our minds always sufficient as food for the zooplankton. Now this brings into our discussion the startling theory propounded by Pütter that the planktonic organisms are not present in sufficient quantity to be food for aquatic animals, and that most of the latter feed on organic carbon compounds in solution. Pütter's work itself has been largely confined to marine organisms, and has been seriously questioned, and, to a great extent,



proved incorrect. As this question, however, is still being investigated, it will not be discussed here except in so far as our observations on Lough Neagh are concerned. The Copepods and Daphnids are most certainly feeding upon the phytoplankton, upon Diatoms and smaller green flagellates, most of which are not captured by the net (in the same way as one of us has shown the marine Copepoda feed). Now as this phytoplankton is extremely abundant, we should expect the zooplankton and other animal dependents to be also very abundant. This is strikingly the case; and at the top of the scale we have the phenomenal abundance of the famous Pollan. The food of this fish will be discussed below.

At the same time, if organic carbon compounds are found in solution, there is no doubt that in many cases they will be made use of by aquatic animals. Though no analyses for organic carbon have been made on Lough Neagh water, we would suggest, from the quantities of phytoplankton, that all the conditions for a large quantity of organic carbon in solution are to be found, and that no doubt the water of the lake is just as abundant in detritus and organic carbon in solution as could possibly be expected for a lake of this size unless abnormally contaminated with organic matter.

"Water-bloom" has occurred on two occasions. One of the most extraordinary "water-blooms" was that caused by *Gomphosphaeria Naegeliana* in September and November. This blue-green alga is extremely prolific in Lough Neagh and occurs frequently all through the year. On November 11th it was present in an extraordinary amount, and formed a compact layer on the surface of the water. Now this alga differs from all others we have dealt with in marine or fresh water in a curious way which has not been noticed before so far as we are aware. It always rises to the surface of the lake if the water is undisturbed, and this buoyancy is a character which, unlike that of all our other planktonic organisms, is retained after fixation and preservation. In our tubes of plankton, containing 5 per cent. formalin, which have stood for two and a half years and have been shaken up at intervals, the plankton forms the normal layer at the bottom of the tube, with, however, *another layer at the surface of the liquid*. Thus it is impossible to estimate the volume of the catch by allowing it to settle, for part "settles upwards" and the rest downward. The material at the surface is entirely composed of one form. Thus in our catches it is possible to remove completely all the *Gomphosphaeria* by simply taking off the surface layer.

If the catch is transferred to 75 per cent. spirit, the alga falls to the bottom on standing like the other constituents, and thus the remarkable difference in buoyancy is not observed.

The zooplankton of fresh water differs greatly from that of such an area as the Irish Sea, not only in the entire absence of certain groups, but in the marked absence of larval forms. Very many marine organisms belonging to the bottom fauna have pelagic larvae which aid in distribution, and this is, above all things, characteristic of the plankton of seas like the Irish, Baltic, and North Sea. The suppression of a free-swimming larva is, however, one of the characteristic features in the life-history of fresh-water animals, and hence one great change in the character of fresh-water plankton. Another feature in such plankton as that from Lough Neagh is the part played by the Rotifera. As has been pointed out above, however, the most characteristic feature of the fresh-water zooplankton is the small number of species present compared with the thousands of the sea. Again, we never find large plankton organisms in the fresh-water zooplankton. The zooplankton of Lough Neagh is almost entirely made up of the following species:—

SCHIZOPODA,	<i>Mysis relicta.</i>
COPEPODA,	<i>Diaptomus gracilis.</i> <i>Cyclops strenuus.</i>
CLADOCERA,	<i>Bosmina obtusirostris.</i> <i>B. longirostris.</i> <i>Daphnia hyaline var. lacustris.</i>
ROTIFERA,	<i>Anurea cochlearis Gosse.</i> <i>A. aculeata Ehrenb.</i> <i>Notholca longispina Kellicott.</i> <i>N. striata Ehrenb.</i> <i>Polyarthra platyptera Ehrenb.</i> <i>Triarthra longiseta Ehrenb.,</i> and other more rare genera.
HELIZOA,	<i>Acanthocystis.</i>
FLAGELLATA,	<i>Dinobryon cylindricum var. divergens (Imh.) Lemm.</i> <i>D. protuberans Lemm.</i> <i>D. sertularia var. thyrsoideum Lemm.</i>

Probably no distribution has been so well discussed as that of *Diaptomus* in the recent paper of Tollinger's.<sup>1</sup> From this we can obtain some information as to the geographical distribution of *Diaptomus gracilis*, which is one of the commonest species of *Diaptomus* in Europe. It occurs in Russian Lapland, Sweden, Norway, Finland, Denmark, France, England, Scotland, many lakes in Ireland, Germany, Austria, Switzerland, Tirol, Russia, Asiatic Russia.

<sup>1</sup> Die geographische Verbreitung der Diaptomiden. Von M. A. Tollinger, Zool., Jahr 1911.

That is to say, it is, above all things, characteristically European. It is usually found in lakes of the plains. Altogether, therefore, it does not lend any particular character to Lough Neagh.

The Cladocera, however, are very different. In the first place, we find two species of *Bosmina*, which rarely occur together, both abundant at the same time. *Bosmina longirostris* and *B. obtusirostris* have been recorded before as occurring together, but this is by no means common, and, as will be seen below, taken together with discoveries in the distribution of the phytoplankton, it is extremely interesting.

*Bosmina obtusirostris* is an arctic species, and was found in the Scottish lake survey in all but the lowland lakes of the south-east. In these lakes *Bosmina longirostris* was common. In the Baltic and north European lakes *Bosmina obtusirostris* is characteristically absent. As a matter of fact, Wesenberg Lund has divided Europe into three regions on the distribution of the *Bosmina* species:—

1. *A Northern partly arctic region.*—Characterized by presence of *Bosmina obtusirostris*. Scandinavia, north Russia, arctic lands.
2. *Central European region.*—Characterized by the absence of *B. obtusirostris*, whilst *B. longirostris* is rare, and *B. Coregoni* is most common.
3. *A southern region.*—Where the longispina group attains the highest development.

Thus the *Bosmina* amongst the zooplankton indicates the same admixture of arctic and central European forms as did the phytoplankton.

Those Rotifera which we have considered in our counts are remarkable for their cosmopolitan character. Thus,

*Anuraea cochlearis*,  
*A. aculeata*,  
*Notholca longispina*,  
*Triarthra longiseta*,  
*Polyarthra platptera*,

are recorded for Greenland, Lapland, and the arctic regions generally, from the central European lakes, and from the alpine lakes. James Murray records most of these forms as general and common in the Scottish lochs; but *Triarthra* has not been found in the great lakes, and *Anuraea aculeata* is very rare, and also absent from the great lakes. *Triarthra longiseta* is common with us, but *Anuraea aculeata* is rare—so much for features of distribution from the point of view of latitude.

Now, let us consider briefly the plankton as a community determined by environment—the environment including all external factors whatever that can act upon the organisms.

The marine plankton is often divided, by those who work at this particular branch of the subject, into oceanic and neritic. Oceanic plankton forms are naturally characteristic of ocean waters far from land. Neritic species are typical of the seas like the Irish Sea. This division, which may appear quite simple, is no simple matter when looked into. Many forms occur both in the oceanic regions, and also in coastal waters and enclosed seas. It is a matter of considerable difficulty to say, with reference to many species, whether a plankton organism is then an oceanic or a neritic form; if, however, we look at the plankton as a whole, there are many features which are peculiar to the plankton of an enclosed coastal area like the Irish Sea or North Sea. The plankton bears some character which stamps it as belonging to an inland sea (using the term to denote an arm of the ocean). Moreover, a comparison will show that while all seas of this kind have the same general character, they each bear sub-characters which individualize them. All plankton communities bear a specific character. They are like the human races, but with still greater marks of difference. Now, the difference between an oceanic and a neritic plankton community is a result of environment. That environment is not, however, merely the different nature of the water. The plankton of an area like the Irish Sea is perhaps marked most by the large number of larval forms present—larvae of fixed organisms which in adult life do not belong to the plankton at all. As examples might be mentioned, *Balanus* larvae, Echinoderm larvae, Crustacean larvae of crabs, lobsters, &c., worm larvae, and so on. Now, oceanic plankton forms, which perhaps could live equally well in coastal water so far as the chemical conditions alone are concerned, would have to enter into competition with those organisms whose special home is in the shallow water. It is probably this very competition that has driven them out in the first case, so that the impossibility of coming back is obvious. Thus we have a particularly good example of the action of other planktonic organisms forming part of the environment for any special form that we may take.

In fresh water the same holds good. Lough Neagh plankton, examined in general, has a particular character which is peculiar to the lake. It is a property of this community, and renders it different from other lake planktons even though they may contain almost all the species.

Moreover, this character, which we shall speak of as the Ethos of the plankton, differs for the seasons, as a glance at the photo-micrographs will show. These photos are of slides, each made by taking a drop from the same

dilution from different catches. They have not been treated to give as many different organisms as possible in any catch in the field of view at once. Neither have they been made to indicate different species. They serve to show the appearance of the plankton at the different dates named, as seen in a low-power view. What determines, then, the character of the Lough Neagh plankton? We may give the following known factors :—

1. Physical environmental factors—
  - (a) Latitude—climate.
  - (b) Depth of water, affecting temperature, relation to bottom, light, &c.
  - (c) Geological nature of rocks drained by lake-water.
  - (d) Area of surface.
  - (e) Purity of water—chemical condition of water.
2. Biological environmental factors—
  - (a) Character of vegetation on banks and bottom.
  - (b) Interaction of animals and plants of the plankton.
  - (c) Interaction of animals and plants present in the water other than plankton.

Now, we have dealt with several features which give a characteristic plankton-ethos to Lough Neagh plankton. Briefly enumerated, they may be taken as—

1. Large quantity of plankton present always.
2. Great development of the blue-green algae.
3. Huge quantities of Gomphosphaeria, Oscillatoria, Tabellaria.
4. Presence of arctic and central European organisms together.
5. Desmid flora and prodigious quantities of certain species of *Staurastrum* at special times.
6. Great abundance of *Mysis relicta*.
7. The relative abundance of all the different organisms that make up the Lough Neagh plankton.

It seems to us that this study of the plankton-ethos has been rather neglected. In only a few cases have attempts been made to correlate the presence of peculiarities with other features in the physical or biological environments.

It is owing to the complex interaction of so many conflicting factors that the plankton of two lakes in the same country and at the same latitude may be entirely different.

Very many of the fresh-water plankton organisms are cosmopolitan. Notwithstanding this, the plankton-ethos of any lake is quite marked.

In Lough Neagh we have a plankton which differs considerably from the lake planktons of the English lakes and Scottish lochs, and resembles that of a district far removed—Denmark. At the same time there are many differences between these two plankton communities. The resemblances are no doubt due to the environment. The lakes have the same shallow waters and large surface-area, the same shelving banks. The presence of *Mysis relicta*, no doubt, is due in both cases to biological factors. The possibility of *Mysis* reaching the waters of a lake is not sufficient alone to account for its presence now. It must have found the conditions suitable for its continued existence.

Messrs. West have shown how the Desmid characters of the English and Scottish planktons are due to certain geological factors. We have emphasized the complex interaction of all the organisms in the lake-waters. A profound study of the plankton in this way should lead finally to the enunciation of certain laws, and, given the climate, physical features of a lake and certain predominant organisms occurring there, it may ultimately be found possible to write off at once a list of organisms that should be found to occur in the plankton, *with their respective abundance* and seasonal changes.

#### ***Mysis relicta.***

This report would perhaps not have been considered incomplete if no mention were made of the interesting relict Schizopod for which Lough Neagh has become famous.

*Mysis relicta* abounds in Lough Neagh waters, and has been collected by numerous naturalists, amateur and professional, by using a light dredge on the bottom. Nowhere in the literature is it spoken of as a common plankton form; and it has certainly been regarded by most workers as a creature living on the bottom or rising at times a few inches above the mud.

It only occurred in a whole year's daylight-plankton catches on one date. On that occasion there was a very heavy sea running, and the bottom net brought up quantities of mud.

Paradoxical as it may appear, *Mysis relicta* is as important a plankton form as any other species of plant or animal caught in the lake. In fact, one might say it was *the most common Crustacean in the plankton.* *Most surprising feature of all, it is present in the plankton of the surface-water for probably the whole year, and in considerable quantity.* Why, then, has *Mysis relicta* been practically entirely absent from the catches? Why have not observers commented upon the fact of a large shrimp-like creature being present in considerable quantities in the water? The answer is that plankton-workers



and others have made their catches under a peculiar condition which prevails for exactly half a year only—that of day, and have apparently considered that the conditions of night and darkness make no difference or only a slight change. It is well known, of course, to all marine biologists that many plankton forms—Schizopods, Cumacea, and Polychaete larvae—rise towards the surface at night. Many, if not most, of these forms occur, however, in the plankton by day. The difference between day and night surface-plankton in the Irish Sea, for example, is probably in the relative numbers of forms present both by day and night. In Lough Neagh, on the other hand, a year's plankton catches by day gave no species larger than Cladocera. The first midnight catch was a striking contrast. It was a calm night with a full moon hidden completely by clouds. The sky gave a kind of dull yellow-green light which just served to make out the outlines of brightly painted or white articles in the boat. A surface haul of a few minutes only was taken, and on the net being emptied in a large vessel of water the latter was simply boiling with *Mysis relicta* actively swimming. The light from the electric torch drove them all to the bottom of the vessel in a few seconds, where they formed almost a solid mass, so numerous were they. No marine catches taken at night ever have shown such startling contrasts as the day and night catches on Lough Neagh. The water was 40 feet deep where these *Mysis* were taken at the surface. An hour and a half at the same place next morning gave not a single individual in the water!

On many an occasion whilst in Belfast and district, I was informed that Lough Neagh was once an arm of the sea, cut off, and gradually converted into fresh water. The proof of this was the presence of *Mysis relicta*; and apparently this was considered quite sufficient by many naturalists to indicate the origin of the lake.

Before discussing this question, we must refer to the origin of the fresh-water plankton. On the whole, the fresh-water plankton differs greatly from the marine plankton. Numerous details were constantly before our eyes—especially when we compared our Irish Sea plankton with that of Lough Neagh. Probably but few fresh-water plankton forms are direct immigrations from the sea, and we must look for some other origin. Wesenberg Lund has treated this subject very carefully, and considers it extremely probable that we must look to the littoral and bottom fauna and flora for the origin of our pelagic organisms. Whether we take this as correct or not, we must look to the sea for the ultimate origin of the limnoplankton, and the question of the migration into fresh water must remain for some time longer unsettled. There is, however, a striking resemblance between many alpine and arctic plankton forms; and other details, too, have led many



planktologists to the view that a large number of the European and North American limno-planktonic organisms have migrated south from the northern regions. Other workers have maintained that in addition to the cosmopolitan forms present, there are others, arctic in appearance, in the alpine lakes which are relics of a fauna which existed in Glacial times, and which migrated partly north and partly south with the melting of the ice. Many of the forms have been considered as relicts. This term has had, however, a very chequered career.

In 1860 a paper was read by Lovén on a marine arctic fauna which was found to occur in certain lakes in Sweden. Amongst the species supposed to represent marine forms were *Mysis relicta* Lov., *Idothea entomon* L., two species of Gammarus, and *Pontoporeia affinis* Lindstrom. Lovén assumed that this fauna had migrated from a Polar sea which once covered Finland, into an arm of the sea which eventually was reduced to the fresh-water lakes examined. The old marine fauna did not disappear entirely, but left some organisms which had adapted themselves to the new external medium. These lakes were termed relict lakes, and the marine species, now in fresh water, "relicts." This relict hypothesis was very favourably received; and many lakes containing organisms of supposed marine origin were supposed to be ancient sea-basins. Again, other species of both plants and animals which occur in regions outside their centre of distribution have been regarded as resulting from Glacial influence, and consequently termed Glacial relicts. Both uses have been carried much too far. Where should one end? Credner's paper in 1898 demonstrated that in a great many cases the marine organisms had mounted the rivers. Other causes may have been at work which resulted in the transference of a species arctic in character or marine to another region. It is necessary always to count on the possibilities of a migration *active* or *passive*; and a relict species is not so easily defined as was at one time imagined. The formation of so-called relict forms is, as a matter of fact, a phenomenon of to-day, and of pre-Glacial times as well as Glacial. Bearing this in mind, we can now consider one of the most characteristic of so-called relicts—one which Lovén met with in the Swedish lakes, and to which reference has already been made.

*Mysis relicta* or, better, *Mysis oculata* Fab. var. *relicta* (Lovén) G. O. Sars, occurs in Swedish lakes, Lake Ladoga, Finnish lakes, Russian lakes, Lakes Superior and Michigan, in Great Lakes of North America, Madü, Dratzig See and Tollen See in North Germany, and Lough Neagh and Loch Erne in Ireland. All these lakes would be considered, according to the work of Lovén, as having been formerly, in the time when *Mysis relicta* first occurred, arms of the sea. The distribution is indeed great; and, according to Tattersall, there

is no doubt that *Mysis relicta* of the Great Lakes in America bears the same characters as *M. relicta* in Ireland and Germany.

Wesenberg Lund has investigated the *Mysis relicta* of the Fureso lake in Denmark, and finds the presence of this organism is to be accounted for in a similar way to that supplied by the theory put forward by Samter and Weltner for the lakes in north Germany. In the latter case the distribution is intimately bound up with the glaciation of northern Europe. As the ice disappeared, the present Baltic Sea area was flooded by a salt icy sea flowing in from the north-east by the White Sea, and later communicating with the North Sea. This was the "Yoldia Sea" (so called from deposits of the mollusc *Yoldia*), and in it lived a Schizopod—*Mysis oculata*.

As the land was elevated, the Yoldia Sea became more and more land-locked, and was then gradually freshened by melting ice, until an inland fresh-water sea—the Ancylus Sea—took its place. In the course of this change the arctic *Mysis oculata* was slowly converted into *Mysis relicta*. Finally, owing to another communication with the North Sea, salt water streamed into the Ancylus Sea, bringing in the marine fauna now present in the Baltic. *Mysis relicta*, however, fled before the invading salt water up the rivers into the lakes of north Germany, where it is now found. This was the sequence of events in Europe. Obviously, for those lakes like Lough Neagh and the Great Lakes of North America, other methods may have been adopted; and the derivation of the same form is due to the same conditions acting upon the widely distributed *Mysis oculata*. Now, so far as Lough Neagh is concerned, we see that one of two methods might have been in play. Either Lough Neagh was connected with the sea, was an arm of the sea, and flooded with salt water, in which *Mysis oculata* lived, or else *Mysis oculata* migrated actively up the river, and was slowly converted into *Mysis oculata* var. *relicta*.

The two forms are very similar, for Sars remarks that the differences between *M. oculata* and *M. relicta* vanish if we compare the adult individuals of one with specimens of the other that have not attained full development. In other words, young *M. oculata* are like adult *M. relicta*. How are we to decide the origin of *M. relicta* in Lough Neagh? The details recorded show that it is simply impossible to state that any lake was an arm of the sea merely because certain marine modified forms occur. The decision lies in the hands of the geologist; and we have only to go back to the end of the Glacial period, Dwerryhouse states,<sup>1</sup> "a most interesting stage being reached when the Antrim Plateau was free from ice, except along its seaward margin. The valleys of the Bann and Lagan were closed near their mouths; and the then more

<sup>1</sup> Dwerryhouse. British Association Report, 1911.

extensive Lough Neagh drained through the now streamless valley at Poyntzpass to Newry, and so into Carlingford Lough; and at another stage by Monaghan, Smithborough, and Clones into the valley of the Erne. Still later, Lough Neagh, which was then continuous with the Lake Belfast of the Geological Survey, drained through the Dundonald valley from Belfast to Newtownards, and so into Strangford Lough." We may assume that at the beginning of these times, *Mysis oculata* occurred in the seas connected with the lake. Perhaps it was even there that *Mysis oculata* underwent its modification into *Mysis oculata* var. *relicta*.

One important point, however, is the connexion between Lough Neagh and the valley of the Erne. This probably means one origin for the *Mysis relicta* in both Lough Neagh and Lough Erne; and it may be that Lough Erne derived the Schizopod from Lough Neagh, or that Lough Neagh derived it from the sea, via Lough Erne.

#### The Pollan.

It is impossible to conclude this account of the plankton of Lough Neagh without some reference to the fish fauna which, though forming no part of the plankton, is so closely bound up with it. Whether the plankton is looked upon as the direct or indirect food of the larger aquatic organisms, there is no doubt that it forms an important and essential link in the chain. Moreover, it must be regarded in some cases as a source of danger to fishes. In Lough Neagh we have seen there is present very much plankton, there is much phytoplankton and correspondingly much zooplankton. There is abundant evidence, too, that the water is well provided with organic substances in solution.

We should therefore expect a large quantity of fish. That this is the case is well known, for there is a famous fishery of one fish alone which provides work for many people, and as the following figures will show is of great value. The most famous fish of the lake is the Pollan. This is a species of salmonoid fish of the genus *Coregonus*. It is rather like a herring in appearance, but with the small dorsal adipose fin of the Salmon. The fish occurs in huge numbers, and is caught with nets. The species *Coregonus pollan* of Lough Neagh is peculiar to the lake. Two other Pollan occur in Ireland, the Lough Erne Pollan (*Coregonus altior*) and the Shannon Pollan (*Coregonus elegans*). It is rather curious that in Loch Lomond, where we have noted many plankton resemblances to Lough Neagh, there is a fish, the Powan, *Coregonus clupeioides*, very like the Lough Neagh Pollan, and also caught in large numbers.

Now it seems rather curious that more work has not been carried out on the Lough Neagh fish, which is of such great importance. The fishermen

[M 2]

have described certain migrations to me, but no account of these migrations seems to exist anywhere. It would be of great interest to follow this line up. Moreover, there seems to be some difficulty even in getting figures for the quantity of fish captured. The following figures have been kindly given by Mr. E. W. L. Holt of the Irish Fisheries, and show the estimated captures for seven years, 1905-1911:—

1905,	. . .	427 tons.	1909,	. . .	300 tons.
1906,	. . .	384 „	1910,	. . .	377 „
1907,	. . .	386 „	1911,	. . .	240 „
1908,	. . .	233 „			

We were usually given to understand in Belfast that the Pollan fed on *Mysis*—nothing else seemed to be mentioned. Tate Regan records the staple food to be *Mysis relicta* (which he incorrectly terms an Entomostracan), but mentions that examination of their stomachs shows that they appreciate insect larvae, shrimps?, small bivalves, and the fry of other fishes. We have examined large numbers of stomachs. In the summer months of 1910 we never found *Mysis relicta* at all in the fish captured at Antrim. The alimentary canals were literally black with the late pupal stages of *Chironomus*. Now *Chironomus* larva occur in prodigious numbers in the mud at the bottom of the lake. Other Pollan caught in summer, and particularly at Antrim, had been feeding on Crustacea, both bottom and pelagic forms being included.

From 45 Pollan, 851 *Mysis relicta* were taken on another occasion. The easiest way to obtain *Mysis relicta*, except by plankton-netting at night, is to catch the Pollan and examine the alimentary canals. From 43 Pollan the following were taken:—

- 204 *Asellus*,
- 99 Molluscs (Bivalves and Gastropoda),
- 5 Insect larvae,

and numerous smaller Crustacea, in addition to *Mysis relicta*.

Huge numbers of Daphnids have been taken from the same Pollan. The species include *Daphnia hyalina* and *Bythotrephes longimanus*. The most extraordinary thing, however, was that on most occasions when Daphnids were found in the alimentary canals, practically nothing else was present. The Crustacea were present in thousands. Moreover, we have *never found Bythotrephes in our catches at all*.

There is still a very great deal to learn about the feeding methods of aquatic animals, both vertebrate and invertebrate. At present, however, since a detailed investigation is being conducted (Moore and others, 1912), any discussion of this subject is inadvisable.

The following account of the movements of the Pollan is very interesting, but it is only culled from the observations of the fishermen. As remarked above, it seems a subject that is well worth following up. The Pollan spawning season commences towards the end of November, and at this time the fish, curiously enough, migrate to the stony or gravelly bottom quite close to the shore. The eggs are left here, and the fish in January travel outwards to the "muddy" bottom, where they remain for some time. Thus in the spring, when our plankton catches were being taken, the fishing was being worked some distance away from Antrim in water of about 40 feet depth. As the summer comes on, in June, the fish once more migrate inshore and occur in hundreds in water of 6 to 12 feet deep. The summer fishing, therefore, is in this shallow water, within a stone's throw of the bank. During the summer the fish appear to be influenced in some way by meteorological conditions, and it is said that they travel irregularly out and inshore. The fishing certainly varies in this way, as our observations have shown. In autumn the fish pass outwards to the muddy bottom areas, where they remain until the month of November and the breeding-season. Such are the facts that are known to fishermen. So far as our knowledge is concerned they seem to be correct for the Antrim corner of the lake.

From the figures kindly supplied by the Irish Department of Agriculture and Technical Instruction it will be seen that there is a steady but small decrease in the amount of Pollan captured. The fishermen all agree that the Pollan fishery is becoming worse, and all the evidence that could be gathered at Antrim goes to show that the year 1912 is so far the worst on record. We are of opinion that the fisheries should be carefully looked into. It may be that the blue-green alga increasing in amount has something to do with the decrease. Other causes, however, are certainly at work, and though there are regulations limiting the size of fish to be caught, and rendering the capture of small fish illegal, we are told that this fishery is regularly carried on. Apparently the officers can only investigate fish which are landed for sale. These are of the normal size, and caught with nets of legal mesh. The small Pollan are captured with other nets and are then actually used to bait lines for the eel-fishery. Thus they escape the authorities' notice, and render futile any regulations that may exist.

[TABLES.]

## L. NEAGH.—Number of organisms in the total catch (Vertical Hc

	Feb. 23.	Mar. 5.	Mar. 17.	Mar. 30.	April 13.	April 27.	May 11.
<i>Asterionella gracillima</i> , ..	42,000	82,500	119,500	173,500	299,000	451,000	715,500
<i>Fragilaria crotonensis</i> , ..	258,000	609,500	819,000	501,300	575,500	415,500	271,500
<i>Synedra revaliensis</i> , ..	—	—	—	—	—	—	—
<i>Synedra sp.</i> , ..	—	—	—	—	—	—	1,500
<i>Amphipleura</i> , ..	500	—	—	—	—	—	1,500
<i>Epithemia</i> , ..	—	1,500	6,000	4,500	—	2,100	—
<i>Cymatopleura elliptica</i> , ..	40,500	119,500	162,000	63,000	44,000	84,800	30,000
<i>Cymatopleura solea</i> , ..	—	—	—	—	3,000	600	1,500
<i>Tabellaria fenestrata</i> , <i>var. asterionelloides</i> , ..	82,000	327,000	375,000	428,000	530,000	624,500	391,500
<i>Surirella</i> , ..	13,500	18,000	24,000	12,000	35,000	29,900	10,500
<i>Melosira sp.</i> , .. (only bottom-surf. catch.)	18,600,000	9,050,000	(Not counted)		4,400,000	(Not counted)	800,000
<i>Stephanodiscus astrea</i> , ..	—	19,000	44,000	25,000	41,000	103,500	42,000
<i>Coscinodiscus lacustris</i> , ..	258,000	1,271,000	1,540,000	909,000	631,500	1,481,000	478,500
<i>Pleurosigma sp.</i> , ..	3,000	9,000	15,000	2,500	7,000	9,600	1,500
<i>Closterium</i> , ..	—	9,000	21,300	12,000	5,000	10,600	13,500
<i>Cosmarium</i> , ..	—	—	—	—	2,500	5,225	1,500
<i>Staurastrum sp.</i> , ..	—	13,500	19,500	12,000	5,000	9,600	1,500
<i>Pediastrum boryanum</i> , ..	30,000	31,500	36,000	8,500	13,000	37,200	20,500
,, <i>duplex</i> , ..	12,000	32,500	27,000	10,500	18,000	31,100	24,200
<i>Kirchniriella obesa</i> .. (bottom-surf. only.)	—	1,000	—	—	—	—	—
<i>Sphaerocystis schröteri</i> , .. (bottom-surf. only.)	—	1,000	(Not counted)		39,000	(Not counted)	121,000
<i>Dictyosphaerium pulchellum</i> , ..	13,000	3,000	—	—	3,000	—	—
<i>Scenedesmus</i> , ..	—	—	3,000	3,000	8,000	11,600	11,000
<i>Eudorina</i> , ..	—	—	—	—	—	—	—
<i>Tribonema</i> , .. (bottom-surf. catch only.)	400,000	950,000	(Not counted)		300,000	(Not counted)	100,000

sen Net through  $\left. \begin{array}{l} \text{top, 10 ft.; bottom, 10 ft.,} \\ \text{top, 20 ft.; bottom, 20 ft.,} \end{array} \right\}$  and all the way.

July 13.	July 27.	Aug. 18.	Sept. 8.	Sept. 29.	Oct. 23.	Nov. 11.	Dec. 1.	Jan. 11.	Feb. 3.
1,242,000	955,500	2,722,500	334,340	378,500	278,000	269,500	176,600	316,000	312,700
174,000	404,500	418,500	13,500	4,750	1,500	1,640	1,500	1,500	—
6,000	27,000	126,000	1,000	2,000	300	—	—	—	—
—	27,000	177,000	3,220	16,250	2,800	4,500	—	—	—
—	3,500	1,500	—	—	—	—	—	—	—
—	—	7,500	—	—	—	—	1,500	—	—
9,000	145,000	100,500	10,610	4,250	8,900	4,240	6,550	2,000	4,010
—	—	—	—	—	1,800	—	—	—	—
1,471,500	3,579,000	78,810,000	344,720	400,000	381,000	1,224,700	935,550	1,239,000	595,200
1,500	19,500	21,300	4,610	11,000	12,800	9,900	4,100	9,000	3,720
350,000	(Not counted)	180,000	1,500	1,000	500	800	—	500	—
46,500	12,000	9,000	2,500	—	300	700	550	—	—
184,000	84,000	148,500	10,100	9,750	11,100	22,100	7,950	3,000	7,900
16,500	12,000	16,500	1,000	—	1,500	—	—	—	210
10,500	48,000	39,000	3,000	2,250	4,500	12,000	8,050	4,550	1,500
10,500	12,000	15,000	5,000	500	300	3,000	550	—	—
9,000	36,000	240,000	388,540	207,350	250,600	244,000	110,350	49,000	14,820
1,500	12,620	39,000	2,000	1,000	7,900	7,200	—	5,500	1,710
—	6,000	45,500	4,110	3,250	3,300	12,400	—	—	720
—	—	1,200	—	—	—	—	—	—	—
(Not counted)	—	25,200	4,000	—	500	—	—	—	—
—	—	6,000	1,000	—	—	—	—	—	—
—	—	1,500	—	—	—	—	—	—	—
1,500	—	13,500	8,720	18,500	17,700	1,780	550	—	—
150,000	(Not counted)	420,000	23,000	(Not counted)	34,000	11,200	15,000	12,500	50,000



	Feb. 23.	Mar. 5.	Mar. 17.	Mar. 30.	April 13.	April 27.	May 11.	May 25.
<i>Anabaena flos-aquae</i> , ..	1,864,500	2,005,000	1,147,000	1,238,500	15,612,500	8,159,500	10,410,500	4,422,500 (Not counted)
<i>Oscillatoria Agardhii</i> , (bottom-surf. catch only.)	10,350,000	2,650,000	(Not counted)		18,050,000	(Not counted)	18,450,000	
<i>Gomphosphaeria Naegeliana</i> ,	286,000	562,500	698,500	902,000	1,317,500	732,000	954,000	313,500
<i>Microcystis spp.</i> , (bottom-surf. catch only.)	41,600	6,500	—	—	12,000	—	5,000	—
<i>Chroococcus</i> , .. (bottom-surf. catch only.)	5,200	1,000	—	—	—	—	—	—
<i>Dinobryon</i> , ..	—	—	10,500	9,000	1,500	—	2,500	3,000
<i>Peridinium</i> , ..	—	—	—	—	500	—	—	1,500
<i>Ceratium</i> , ..	—	500	—	—	8,000	7,000	10,500	—
<i>Carchesium</i> , ..	—	—	—	—	—	—	—	3,000
<i>Tintinnidium</i> , ..	—	1,500	9,000	6,000	3,500	7,300	1,500	4,500
<i>Acanthocystis</i> , ..	3,000	—	16,500	15,500	24,000	13,075	16,500	4,900
<i>Diaptomus gracilis</i> , ..	880	1,080	1,352	1,169	3,620	2,879	3,200	732
<i>Cyclops</i> (chiefly <i>strenuus</i> ), ..	160	160	200	250	500	240	520	242
<i>Bosmina spp.</i> , ..	280	430	548	1,952	8,580	4,794	27,800	1,412
<i>Daphnia hyalina</i> , <i>var. lacustris</i> .	—	—	—	—	120	162	1,520	6,000
Nauplii (copepod), ..	4,500	4,500	7,500	6,500	18,000	12,137	7,500	25,500
<i>Anurea cochlearis</i> , ..	10,500	16,000	16,500	14,000	13,000	12,300	12,000	6,000
<i>Anurea aculeata</i> , ..	—	—	—	1,500	—	2,000	1,500	4,500
<i>Polyarthra platyptera</i> , ..	—	—	—	—	—	—	—	—
<i>Notholca striata</i> , ..	13,500	22,000	13,500	3,000	500	—	—	3,000
<i>Notholca longispina</i> , ..	3,000	1,500	2,500	7,000	4,500	—	5,500	3,000
<i>Triarthra longiseta</i> , ..	—	—	—	1,500	500	5,700	1,500	—
<i>Mastigocerca</i> , ..	—	—	—	—	—	—	—	7,500
<i>Rotifera spp.</i> , ..	—	—	1,500	6,000	7,500	—	4,500	—
<i>Mysis relicta</i> , ..	—	—	40	—	—	—	—	—

June 10.	July 13.	July 27.	Aug. 18.	Sept. 8.	Sept. 29.	Oct. 21.	Nov. 11.	Dec. 1.	Jan. 11.	Feb. 3.
3,811,500	90,000	111,000	582,000	99,330	77,600	186,500	8,200	1,500	3,000	10,000
17,900,000	14,200,000	(Not counted)	420,000	8,500	(Not counted)	5,500	1,600	(Not counted)	—	50,000
570,000	243,000	361,500	760,500	1,372,940	6,562,500	9,431,500	<b>13,646,510</b>	9,469,000	4,605,000	1,118,670
1,100	500	600	2,400	500	—	500	1,500	1,000	500	400
1,100	500	—	3,600	500	—	500	500	500	—	—
25,500	121,500	<b>462,000</b>	12,000	220	—	—	—	—	—	—
—	6,000	10,500	<b>90,000</b>	3,000	1,500	—	—	—	—	—
16,500	106,500	421,500	<b>2,086,500</b>	233,710	149,750	12,500	940	500	—	—
—	—	—	13,500	10,050	3,000	—	—	—	—	—
—	—	3,000	12,000	1,000	—	1,500	2,400	1,500	1,500	1,500
1,100	3,000	14,120	—	—	—	—	—	1,500	—	—
2,420	2,520	3,935	2,979	2,160	4,195	<b>5,336</b>	3,807	2,812	5,170	1,600
1,230	2,560	3,425	1,717	1,550	2,630	<b>4,722</b>	2,536	2,050	2,482	1,460
1,190	800	380	40	—	—	—	—	—	—	—
<b>6,690</b>	3,160	1,405	1,463	400	380	345	40	40	—	—
13,500	3,000	16,500	25,500	23,220	13,000	19,900	7,200	7,100	7,500	7,230
33,000	24,000	<b>142,500</b>	136,500	14,160	33,750	57,800	29,600	18,454	28,500	3,130
6,000	4,500	8,000	1,500	500	—	—	—	—	—	420
6,000	7,500	28,500	<b>51,000</b>	47,720	29,250	20,800	2,140	4,650	—	—
—	—	—	—	—	—	1,500	280	500	800	400
9,000	6,000	4,500	6,000	3,000	500	1,500	—	8,000	—	3,000
15,000	33,000	<b>39,000</b>	1,500	2,000	—	1,500	—	—	—	—
—	—	—	7,800	3,000	—	—	—	—	—	—
13,500	9,000	90,000	22,500	6,000	13,000	8,000	—	—	—	—
—	—	—	—	—	—	—	—	—	—	—

## APPENDIX.

## LIST OF MOLLUSCA OCCURRING IN LOUGH NEAGH.

The following list of the mollusca occurring in the lake has been very kindly drawn up by Mr. R. Welch, M.R.I.A. :—

## GASTROPODA.

## LIMNAEIDAE.

- Ancylus fluviatilis* Müller.  
*lacustris* Thompson.  
*Limnaea pereger* (Müller).  
*stagnalis* (Linné).  
*palustris* (Müller).  
*truncatula* (Müller).  
*Planorbis albus* Müller.  
*carinatus* Müller.  
*spirorbis* (Linné).  
*confortus* (Linné).  
*fontanus* (Lightfoot).

## PHYSIDAE.

- Physa fontinalis* (Linné).

## PALUDESTRINIDAE.

- Paludestrina jenkinsi* Smith.  
 Rare in 1900. Now present in  
 myriads.  
*Bithynia tentaculata* (Linné).

## VALVATIDAE.

- Valvata piscinalis* (Müller).  
*cristata* Müller.

## LAMELLIBRANCHIATA.

## UNIONIDAE.

- Anodonta cygnea* (Linné).

## CYRENIDAE.

- Sphaerium corneum* (Linné).  
*lacustre* (Müller).

- Pisidium amnicum* (Müller).  
*subtruncatum* Malm.  
*pulchellum* Jenyns.  
*obtusale* Pfeiffer.  
*pusillum* (Gmelin).  
*milium* Held.

BIBLIOGRAPHY.

- AMBERG, O. :  
 Beiträge z. Biologie d. Katzenses. Viertelj. Naturf. Ges. Zurich, Bd. 45.  
 1900.
- APSTEIN. :  
 Das Süßwasserplankton. Kiel, 1896.  
 Die Schätzungsmethode in d. Planktonforschung. Wiss. Meeresunters, N.  
 F., Bd. viii. Kiel, 1905.
- BURCKHARDT :  
 Quant. Studien a. d. Zooplankton d. Vierwaldstättersee. Mitt. Naturf. Ges.  
 Luzern, 1900.
- CASPARI, W. A. :  
 Chemical Compositions of Lake Waters. Bathy. Survey of Scottish Fresh-  
 water Lochs, vol. i. Edinburgh, 1910.
- CREDNER, R. :  
 Die Reliktenseen. Ergänzungsh., No. 86, zu. Petermanns Mitteilungen.  
 1877-88.
- DAKIN, W. J. :  
 The Food of the Copepoda. Int. Revue d. Hydrobiologie. 1908.  
 Plankton Methods. Proc. Liverpool Biol. Soc., vol. xxii. 1908.
- DAKIN (Herdman and Scott) :  
 Plankton of Irish Sea. Rep. Lancs. Sea Fisheries Lb. No. xix. Liverpool  
 1910.
- EKMAN :  
 Über d. Crustaceenplankton von Ekoln und marinen Relikten in schwedi-  
 schen Binnenseen. Särtryck ur Zoo. Stud. till Tullberg. 1907.
- HAECKEL :  
 Planktonstudien. Jena.
- HENSEN, V. :  
 Über d. Bestimmung d. Plankton. Ber. d. Komm. z. wiss. Unters. der  
 deutsch. Meere. Kiel, 1887.
- HUDSON and GOSSE :  
 The Rotifera. London, 1886-89.
- KANE, W. F. de. V. :  
*Mysis relicta* in Ireland. Ann. and Mag. Nat. Hist. (7th S.), vol. viii.  
 1901.

[N 2]

## KOFROID :

Plankton of Illinois River. Bull. Ill. State Lab. of Nat. Hist., vol. vi, 1903,  
and vol. viii, 1908.

## KRÄTZSCHMAR :

Über d. Polymorphismus von Anuraea Aculeata. Inter. Revue. d. g.  
Hydrobiol. 1908.

## LOVÉN :

Om några i Vettern och Venern funna Crustaceer. Öfersigt af Kgl,  
Vetensk-Akad. Förhandl. Stockholm, 1855.

## LANGHANS, V. :

Die Ursachen der periodischen Variationen d. Planktozoen. Lotos. Prag.,  
1907.

## LOHMANN, H. :

Das Nannoplankton. Internat. Revue de Hydrobiologie, Tome iv. 1911.

## LAUTEBORN :

Der Formenkreis v. Anuraea cochlearis. Verh. nat. med. Ver. Heidelberg.  
N. F., Bd. 6, 7. 1901, 1902-4.

## LILLJEBORG, W. :

Cladocera Sueciae. Upsala, 1910.

## MURRAY, James :

Biology of Scottish Lochs. Bathy. Survey, etc. Edinburgh, 1910.

## MURRAY, Sir J. :

Characters of Lakes in general and their distribution. 1910.

## MOORE, WHITLEY, EDIE, and DAKIN :

The Nutrition and Metabolism of Marine Animals. Bio. Chem. Journ.,  
vol. vi. 1912.

## OSTWALD :

Zur Theorie der Schwebevorgänge sowie der spezifischen Gewichtsbestimm.  
schwebender Organismen. Arch. ges. Phys., Bd. 94. 1903.

Exp. unter. über d. Saisonpolymorphismus bei Daphniden. Arch. Entwickl.  
Bd. 18. 1904.

## PÜTTER, A. :

Die Ernährung der Wassertiere. Leit. f. allg. Physiologie, Bd. 7. 1907.  
Der Stoffhaushalt.

## TATE REGAN :

British Freshwater Fishes. London, 1911.

## SAMTER :

Die geogr. Verbreitung von Mysis relicta, etc., in Deutschland. Anhang. z.  
Abh. d. königl. preuss. Akad. d. Wissensch. Berlin, 1905.

SAMTER and WELTNER :

Biolog. Eigentümlichkeiten der *Mysis relicta* erklärt u. s. w. Zool. Anz. 27.  
1904.

SARS :

Crustacea of Norway. Vols. iv. and v.

SCHEMEL :

Deutschlands freilebende Süßwassercopepoden. Bibliotheca Zoologica.  
1892.

SCHROETER and VOGLER :

Variation stat. Unter. ü. *Fragilaria crotonensis* Viertel. naturf. Ges. Zurich,  
Bd. 46. 1907.

STEUR :

Planktonkunde. Berlin, 1910.

WESENBERG LUND :

Plankton of Danish Lakes. Copenhagen, 1904.

Comparative Study of Lakes of Scotland and Denmark. Proc. Roy. Soc.  
Edinburgh, xxv. 1905.

Sur l'existence d'une faune relicte dans le lac de Fureso. Oversigt Vidensk.  
Selskabs. Forh. 1902. No. 6. Copenhagen.

WEST, W., and G. S. WEST :

Freshwater Algae of North Ireland. Trans. Roy. Irish Acad., xxxii. 1902.

Scottish Freshwater Plankton. Journ. of Bot., Linnean Soc., xxv. 1904.

Freshwater Plankton of Scottish Lochs. Trans. Roy. Soc. Edinburgh. 1905.

Comparative Study of Plankton of some Irish Lakes. Trans. Roy. Irish  
Acad. xxxiii. 1906.

The British Freshwater Phytoplankton, etc. Proc. Roy. Soc. London, 1909.

Periodicity of Phytoplankton of some British lakes. Journ. Linn. Soc., Bot.  
xl. 1912.

WOLTERECK :

Über natürliche u. künstliche Varietätenbildung bei Daphniden. Ver. d.  
deutsch Zool. Ges. 1908.

[EXPLANATION OF PLATES.

## EXPLANATION OF PLATES.

## PLATE IV.

FIG.

1. Lough Neagh. Typical view looking over lake. Near Toome.
2. Shore of Lough Neagh, showing sand-flats exposed at Shane's Castle.
3. Banks of Lough Neagh and lake view.

## PLATE V.

4. Pollan-nets drying on banks of Lough Neagh, near Antrim.
5. Mouth of Six Mile Water, near Antrim.
6. Banks of Lough Neagh, near Six Mile Water, showing grasses and wooded nature of country.
7. Fishing-boat hauling Pollan-nets near banks. This boat was used for the plankton investigations.

## PLATE VI.

8. Type of Plankton. April, 1910. Chiefly *Oscillatoria* and *Gomphosphaeria*.
9. Type of spring Plankton.
10. Type of Plankton, July 27, 1910.
11. Type of Plankton at time of *Tabellaria maximum*, August 18, 1910.
- 12 and 13. Surface Plankton during period of water-bloom, late September, 1910.



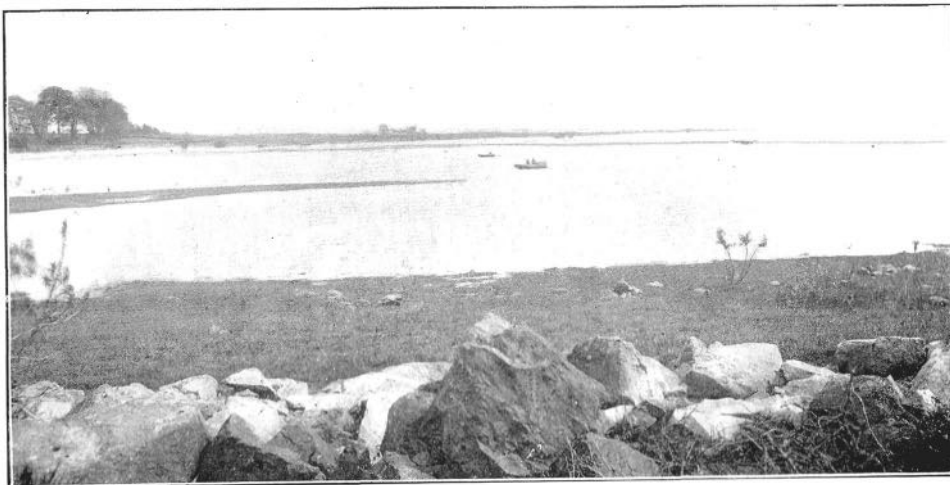

Fig. 1.—Lough Neagh, near Toome.

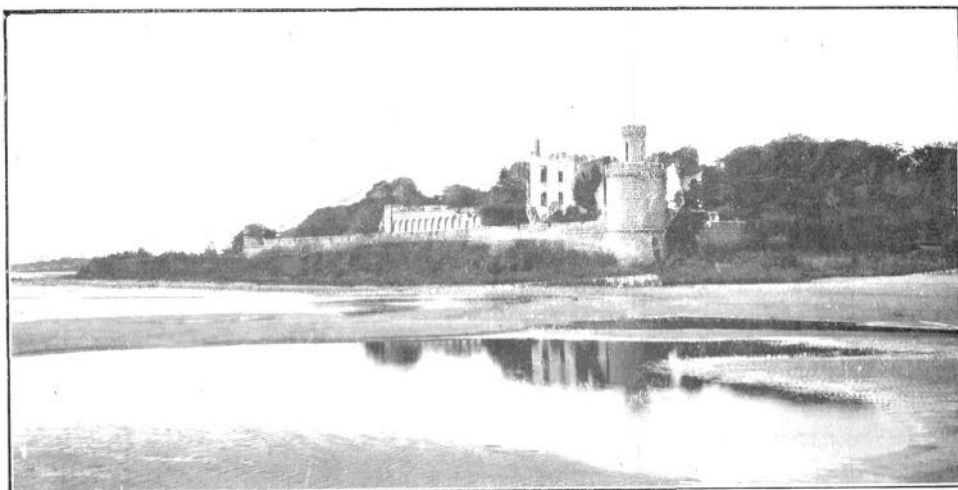

Fig. 2.—Shore of Lough Neagh at Shane's Castle.

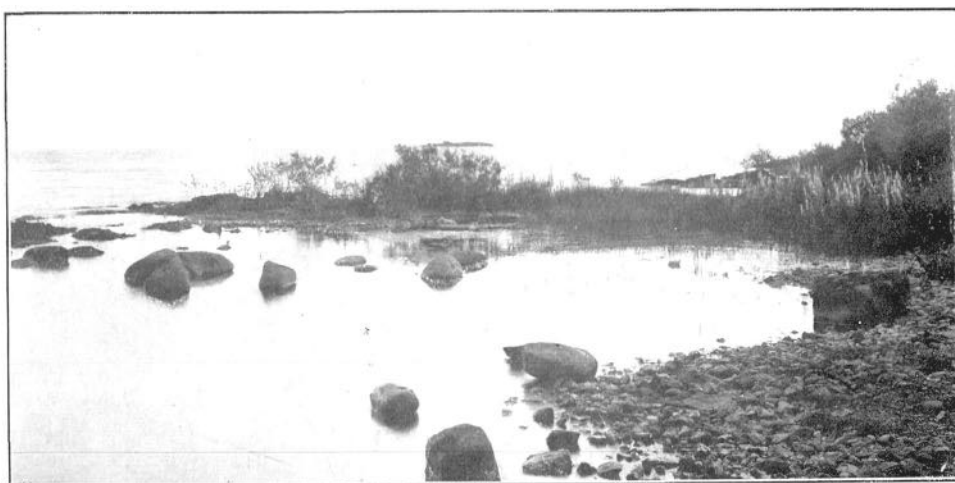

Fig. 3.—Lough Neagh—typical view.

DAKIN AND LATARCHE.—PLANKTON OF LOUGH NEAGH.

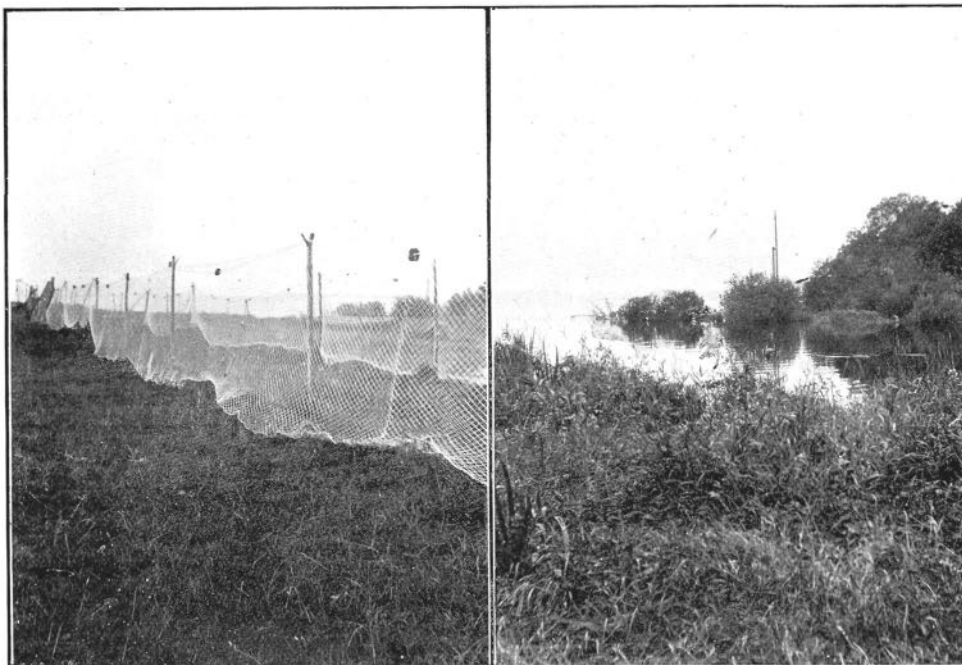

Fig. 4.—Pollan-nets drying. Lough Neagh, near Antrim.

Fig. 5.—Mouth of Six Mile Water, Lough Neagh, Antrim.

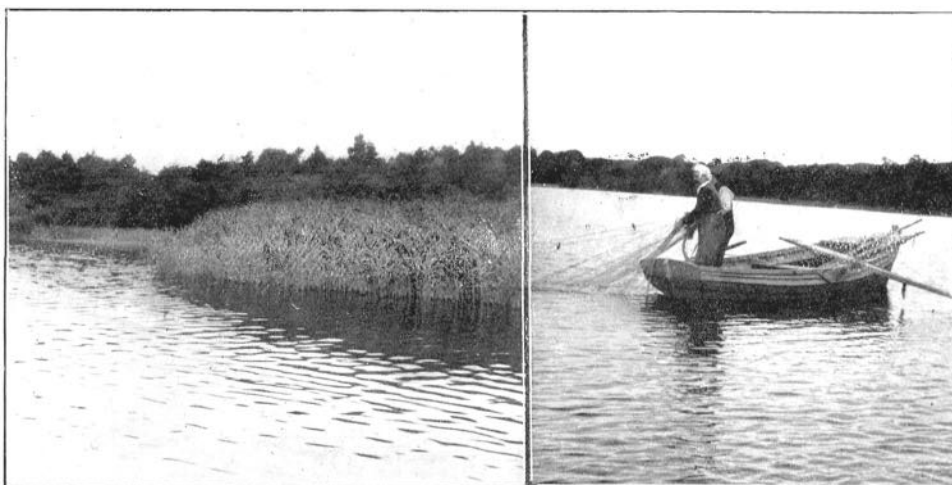

Fig. 6.—Lough Neagh. Banks near Six Mile Water.

Fig. 7.—Pollan Fishing-boat. Lough Neagh, near Antrim.

DAKIN AND LATARCHE.—PLANKTON OF LOUGH NEAGH.

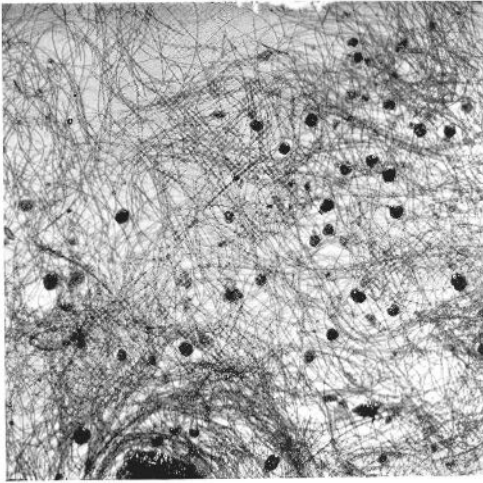

Fig. 8.

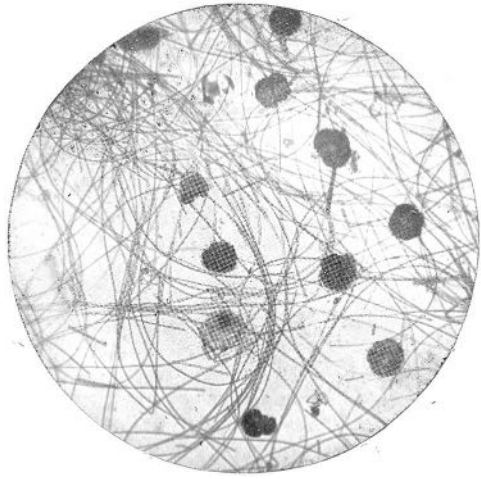

Fig. 9.

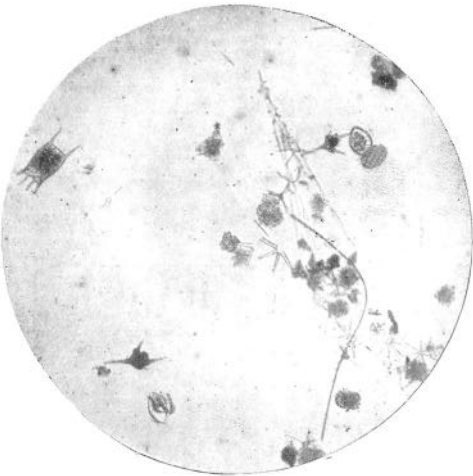

Fig. 10.

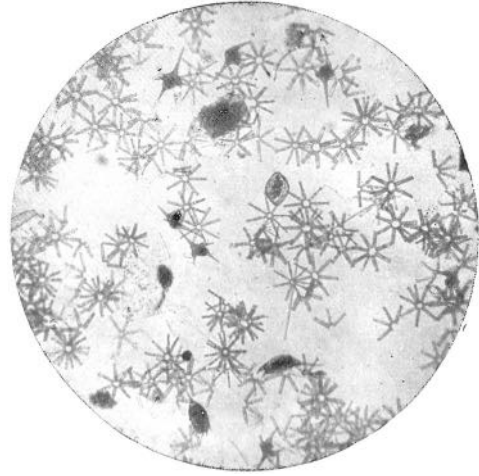

Fig. 11.

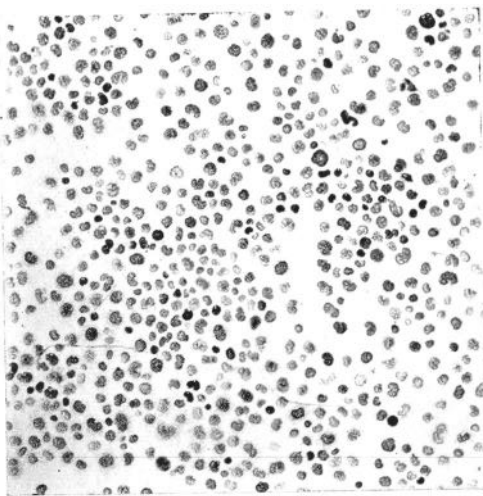

Fig. 12.

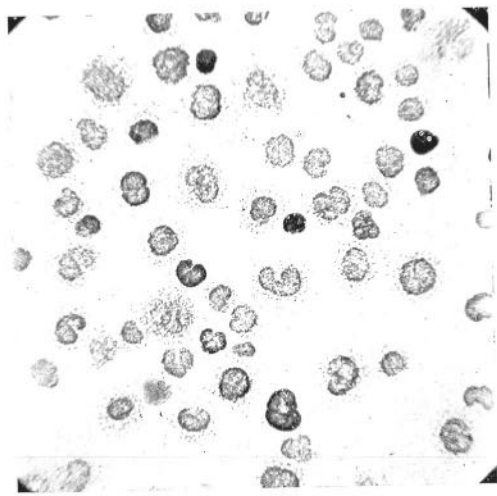

Fig. 13.

DAKIN AND LATARCHE.—PLANKTON OF LOUGH NEAGH.